



# SWAROVSKI

Swarovski Components Collection



# A Story of Passion and Innovation

In 1895, Daniel Swarovski revolutionized the fashion and jewelry industries with his captivating precision-cut crystals.

An inventor, an engineer, but most of all a visionary, Daniel Swarovski became enthralled by electricity and its immense possibilities. Creating and patenting the first electricity-powered cutting machine in 1892, at a time when crystals were all cut by hand, he and his partners, Franz Weis, and Armand Kosmann, sought a suitable location for their burgeoning business based outside of Bohemia.

Wattens, a picturesque village in the Austrian Alps offered many advantages – distance from imitators, a transport link to the fashion capital of Paris, and above all an abundance of water to generate the hydroelectricity needed to power his innovation.

The future was set in motion, and the Swarovski Empire was created. Daniel Swarovski's enduring passion for innovation and design has made Swarovski the world's premier jewelry and accessory brand, and today the family continues to carry on the tradition of delivering extraordinary brilliant style to people around the globe.



## Brilliant Creativity

From idea and inspiration, through to the final collection, Swarovski's creative process is uniquely prolific with a focus on trend curation, design, and meaningful branding. Embodying over 125 years of technical expertise and a mastery of cutting crystals, every Swarovski piece tells its own radiant story. It is precisely this continuous evolution of material and technique that crowns Swarovski the leader of cut creations. In celebration of innovation, artistry and cooperation, with a long history of working with esteemed artists on a global scale, we are continually held spellbound by what our crystals can achieve in the hands of the world's finest designers.

## Unparalleled Know-how

Over 125 years ago, Daniel Swarovski's vision was to create "a diamond for everyone", marking the beginning of a new era for crystals. This premise still holds true today with innovation and imagination remaining at the forefront of everything we do. New cuts, colors, and sizes are consistently conceived, and realized in our historical headquarters in Austria as we push the boundaries of fabulous, tireless in our pursuit of the new and next. Our savoir-faire in refining and shaping crystals allows us to deliver renowned, and exceptionally exquisite pieces in the most comprehensive assortment in the industry.

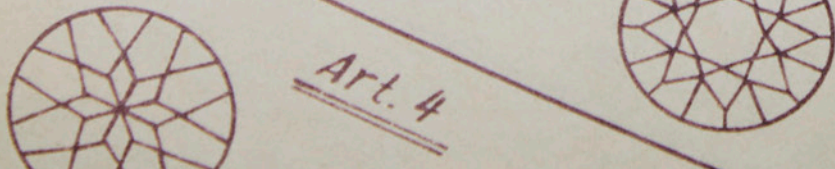
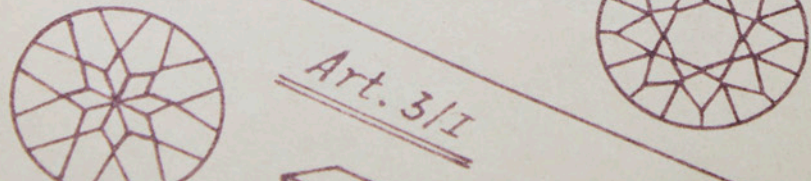
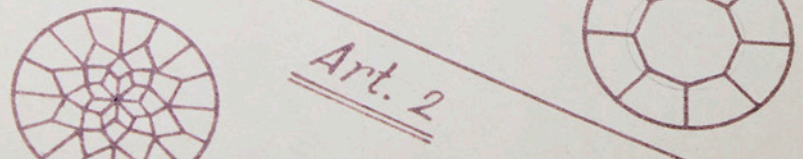

$\phi$	$H_1$
5	22
6	24
7	27
8	29
9	31
10	33
11	34
12	35
13	36
14	37

72

56

56



# Made-to-Order at its Brilliant Best

Merging our refined assortment of both Crystal Components, and Forward Integrated Elements, our Customized Product Solution Services are designed to help you realize your specific vision, and extend your unique artistic expression.

We understand that individuality is what makes us all stand out, and our Customized Color and Effect Service is specifically tailored to enable you to achieve the personalized style you desire.

Our color assortment consists of 100 various hues, effects, and lacquer combinations, but if you desire something specific to suit your own color scheme, our brilliantly tailored mix-and-match options allow you to create your own statement component, ensuring luminous design is made extra easy.

We also offer a range of solutions for different shape and size, logo and motif variations. For any of these designated special services please get in touch with us at Swarovski.

# Crafting a More Brilliant Future

At Swarovski, we want to help craft a more brilliant future for people and planet. We want to be recognized as a Brand that acts with that purpose in mind by focusing on circular innovation and celebrating individuality. This means making conscious choices that create long-term value for individuals, societies, and the natural world around us, as well as for our business. We recently introduced ambitious commitments that were defined across five focus areas most material to our business: Greenhouse Gas emissions, Waste & Circularity, Conscious Materials, Rights & Respect, and Equity, Diversity & Inclusion.

We are continuously making progress to increase the sustainability credentials of our products, including responsibly sourced and recycled raw materials. For example, we recently introduced our Crystal Fishnet Banding where thread and casing are made from 100% certified recycled materials. We believe this new product contributes to the better choices of materials available in the fashion industry. We have also continued to offer reignited crystals, which gives unused stock another chance to be adored and therefore helps us mitigate waste.

Some other great efforts are being made to reduce our greenhouse gas emissions by using more renewable energy amongst other initiatives; for example, we recently installed our first large-scale photovoltaic plant – turning light source into electricity – at our headquarters in Wattens. We are also working hard to reduce our waste and making progress towards our goal to transform our own operations to become 90% landfill-free by 2030.

We want to be known as a Brand that champions diversity and celebrates people's individuality, building a welcoming and safe space for everyone in our business and in society. We also recognize that the way our employees behave and the way we treat them, affects our overall impact on society and the environment, that is why we offer numerous learning opportunities and awareness workshops to our employees worldwide, amongst many other initiatives.

Achieving Swarovski's unparalleled mastery of light takes a complex, global operation. Making sure we deliver our extraordinary savoir-faire sustainably requires the enduring expertise of our people, coupled with transformative initiatives that reach into every corner of the world.







# The Manufaktur of Dreams

## Crystal Atelier of the 21<sup>st</sup> century

The reinvention of our cherished brand started with the opening of the now world-renowned Manufaktur at Swarovski Headquarters, Wattens.

A state-of-the-art, hangar-like space drenched in natural daylight and dedicated to an evolved customer collaboration, the “Crystal Atelier of the 21st century” was the original space where science and magic came together, where our customers’ dreams became reality, and innovation and product development took flight.

What began with a desire for closer connection, a yearning to conjure up crystalline dreams and create alongside our customers has evolved into a global journey of immense scale and design.

**We’re so very glad you joined us.**

# Crystal Workshops of the Future

There is a tangible energy evident in what is going on in Wattens, with the Manufaktur being just one of three major developments that were undertaken in 2020.

A new cutting center for crystals, “the crystal factory of the future” and Campus 311, an innovation and product development center, complete the huge investment done in the Wattens site.

## **Swarovski Manufaktur: An Emotional Experience**

The Manufaktur is reached by a newly constructed footbridge from Campus 311. “You pass through a central staircase, which is created from dark materials, with black steel and a dark terrazzo flooring,” explains Kjetil Trædal Thorsen, founding partner of the Norwegian architects Snøhetta, responsible for the Manufaktur. “A sliding door opens and you experience an amazing and inspiring moment as you step into this very bright and light-filled space from a slightly declining floor across the bridge. Entering the Manufaktur is really an exceptionally emotional experience.”

## **Space for Inspiration and Co-Creation**

The Manufaktur is a vast hangar-like space; radiant with natural daylight beaming through its glass roof, with clear sightlines in every direction. There is virtually no obvious means of ceiling support and walking into the new building it feels as if you are stepping into the future. When a client arrived from India to work on one of the earliest projects to take place at the Manufaktur, she was overwhelmed.

Swarovski has worked with Snøhetta before. They were the architects of the play tower at Swarovski Crystal Worlds, built in 2015. With offices in Oslo and New York and studios in Innsbruck and several other cities around the world, the architectural practice has a portfolio of large, ambitious structures, including museums, libraries, office and residential complexes, and the Oslo Opera House for which they won the 2009 Mies van der Rohe Award. The new structure for Swarovski, which covers close to 8,000 square meters over three levels, is a consistent addition to Snøhetta’s catalog of projects.



## Skills and Capabilities Directly Accessible to Clients

While the Manufaktur, sits on the company's foundations within the grounds of the existing family-run factory, it also represents new possibilities for the global creative brand. As Langes-Swarovski explained: "The uniqueness of the Manufaktur is that it brings existing skills and capabilities under one spectacular roof, making them directly accessible to our clients. It is a space for inspiration and co-creation that enables them to transform their ideas into real crystal objects in a very short period of time – not just digital twins or plastic 3D-printed copies, but actual crystal creations with their true sparkle, touch and feel."

While the focus is on future collaborations and, as Langes-Swarovski said, "serendipity and a much higher hit rate for coincidences", the first project at the building was for Swarovski itself – 30 different designs, involving 300 pieces, for the Atelier Swarovski home collection. "It represented what will be a typical Manufaktur project," explained Langes-Swarovski. Some of the cutting-edge technology at the new building incorporates the ability to create Wave Cut convex or concave shapes, and large objects up to 80cm in diameter.

Manufaktur is also the birthplace of Swarovski's future iconic products. Our goldsmiths, master cutters and gluers of crystals handcraft the first prototypes of the newest jewelry and home designs thereby bringing the imagination of our creative direction to life.

## Changing the Way We Innovate

Snøhetta's architectural approach to this project has a sophistication that tells a story about the process and the relationships that the Manufaktur will nurture. There is nothing overly literal about the design of the building – it is about mood and function rather than novelty and gimmicks. "We tried not to interpret the physical properties of crystals in our building geometry," explains Thorsen. "We have tried to understand what makes crystal so special and attractive and use these ephemeral qualities to create a specific atmosphere. It is a space that has an incredible amount of daylight penetration, something unseen in any other production facility. Crystals only come to life with light, so for us it is the intense presence of that daylight that is the most important aesthetic aspect of this building."

The sense of transparency and openness within the new Manufaktur building makes it as visceral and as thrilling as it is practical and conducive to creating innovations. "Introducing a new typology of work, the Manufaktur is a new chapter for us and our clients, and we look forward to see how the new buildings change the way we innovate, work together and think. As Winston Churchill once said: 'We shape our buildings, and afterwards our buildings shape us.'"



# Contents

## **20 BASIC INFORMATION**

- 22 Key Facts
- 23 Colors & Effects Overview

## **28 CARE INSTRUCTIONS**

## **38 01 ROUND STONES**

- 40 Colors & Effects
- 41 Summary
- 49 Product Details

## **52 02 FLAT BACKS NO HOTFIX**

- 54 Colors & Effects
- 56 Summary
- 80 Product Details

## **84 03 FLAT BACKS HOTFIX**

- 86 Colors & Effects
- 88 Summary
- 111 Product Details

## **114 04 SEW-ON ARTICLES & CRYSTAL BUTTONS**

- 116 Colors & Effects

### **117 Sew-on Articles**

- 118 Summary
- 127 Product Details

### **129 Crystal Buttons**

- 130 Summary
- 132 Product Details

## **134 05 FANCY STONES**

- 136 Colors & Effects
- 137 Summary
- 166 Product Details

## **170 06 BEADS**

- 172 Colors & Effects
- 174 Summary
- 190 Product Details

## **192 07 CRYSTAL PEARLS**

- 194 Colors
- 196 Summary
- 197 Ordering Example & Product Variety Explanation
- 205 Product Details

## **206 08 PENDANTS**

- 208 Colors & Effects
- 209 Summary
- 234 Product Details

## **238 09 CRYSTAL TRANSFERS**

- 240 Overview of Flat Backs Hotfix for Crystal Transfers
- 242 Crystal Diamonds
- 243 Metallics

### **244 Inspirational Motifs**

- 251 Special Motif Service

### **252 Crystal-it Infinity**

- 254 Flat Backs for Crystal-it Infinity
- 257 Inspirational Motifs
- 258 Special Motif Service

**260 10 CRYSTAL TEXTURES**

262 Crystal Textures Products and Fields of Application

**264 Crystal Fabric Bandings**

268 Colors &amp; Effects

**242 Crystal Fabric Inspirational Motifs**

272 Inspirational Motifs

273 Special Motif Service

**274 Crystal Intarsia**

279 Inspirational Motifs

281 Special Motif Service

**282 Crystal Rocks, Fine Rocks & Ultrafine Rocks**

285 Colors &amp; Effects

290 Inspirational Motifs

293 Special Motif Service

**294 Graphic – The Limitless Crystal Printing Technology**

297 Colors &amp; Effects

299 Inspirational Motifs

299 Graphic Fabric

300 Graphic Rocks

301 Graphic Fine Rocks

302 Graphic Fine Rocks XS

303 Graphic Ultrafine Rocks

303 Graphic Ultrafine Rocks XS

304 Graphic Metallic Colors

305 Colors &amp; Effects

306 Inspirational Motifs

306 Graphic Fabric

307 Graphic Fine Rocks

308 Graphic Fine Rocks XS

309 Graphic Ultrafine Rocks XS

310 Information on Graphic

312 Into the Wild with the Swarovski Exotics Collection

312 Standard Collection Graphic Fabric

313 Standard Collection Ultrafine Rocks

**317 Crystal Textures Special Product Features**

317 Lacquered Foils

319 Inspirational Motifs

321 Lacquered Foils with Electric Lacquer<sup>PRO</sup> Effects

323 Inspirational Motifs

325 Crystal Textures extra small (XS)

326 Crystal Fine Rocks XS

327 Inspirational Motifs

328 Crystal Ultrafine Rocks XS

329 Inspirational Motifs

330 Special Motif Service

331 Crystal Textures Unlimited

332 Crystal Fabric Unlimited (UL)

334 Special Motif Service

335 Foil Overlay for Crystal Fabric, Crystal Rocks,  
Crystal Fine Rocks & Crystal Ultrafine Rocks

340 Special Motif Service

**341 Crystaltex Chaton Bandings****344 11 LINKED CRYSTAL COMPONENTS****347 Crystal Mesh**

348 Crystal Mesh Standard

352 Crystal Fine Mesh

356 Crystal Mesh Motifs

357 Crystal Mesh Inspirational Motifs

359 Special Motif Service

360 Crystal Light Mesh &amp; Crystal Light Mesh Mini

364 Crystal Mesh Colorée &amp; Crystal Mesh Colorée Mini

369 Product Details

**371 Cupchains**

372 Round Cupchains

376 Round Extended Cupchains

380 Bezel Chains

384 Multi-Row Cupchains

389 Special Motif Service

**391 Bandings**

392 Crystal Fishnet Bandings

**396 12 CRYSTAL RIVETS & ROSE PINS**

398 Crystal Rivets

402 Back Parts for Rivets

403 Rose Pins

**409 13 APPLICATION TOOLS**

410 Crystal Glues CG 500 (A+B) &amp; CG 610 (A+B)

410 Available Packaging Versions

412 Gluing Tools

413 Mechanical Tools

414 Tools for Rivets

415 Tools for Rose Pins

416 Hotfix Application Tools





# Why Swarovski

## EXCELLENCE, THROUGH INNOVATION AND ORIGIN

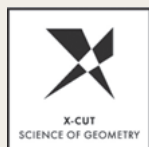

### X-CUT

Advanced optical measurement and high-precision manufacturing deliver premium cuts characterized by unmatched brilliance.

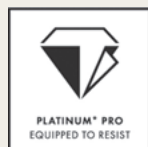

### PLATINUM\* PRO

With its new advanced foiling technique, Swarovski has set a new standard in the lifespan of crystals.



### HOTFIX GLUE

The variable temperatures at which Hotfix glue can be activated enable the application of crystals on a broad range of textiles.



### CRYSTALS – MADE IN AUSTRIA

The combination of innovation with sustainability and respect for individual wellbeing means that quality is always assured.

## PREMIUM, BY SERVICE AND DESIGN

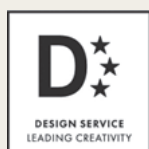

### DESIGN SERVICE

Throughout its global network of Design Centers, Swarovski offers exceptional service provided by the industry's best creative talent.

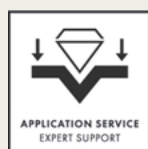

### APPLICATION SERVICE

A comprehensive range of application services means customers benefit from the extensive experience of leading international experts, as well as internal specialists.



### GLOBAL SERVICE

Swarovski's Global Service Network provides customers with dedicated personal assistance on a local level.

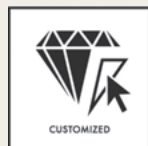

### CUSTOMIZED SERVICE

Choose new variations by going beyond Swarovski's tremendous standard assortment of Swarovski components and forward-integrated elements.

## COMPLIANCE, WITH INTEGRITY

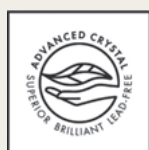

### ADVANCED CRYSTAL

Swarovski's patented lead-free\*\* formula has changed the DNA of crystals while still offering the same sparkle, dependability, and variety for which the brand is famous.



### OEKO-TEX

Oeko-Tex® Standard 100 Class II (direct contact with skin) certification creates confidence in the chemical safety of textile applications.

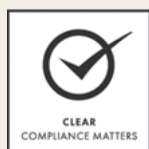

### CLEAR

Regular legal monitoring of chemical requirements and reasonable testing provide customers with the comfort of trust in Swarovski's products.



### COMPLIANCE SERVICE

Assessments regarding substance limitations, as well as compliance information and advice to support customers in complying with relevant laws, regulations, and voluntary standards.

\* Silver mirror coated with a platinum-colored protective layer.

\*\* Crystal glass and all other materials containing 0.009% lead or less.

# Basic Information



# Key Facts

## COLLECTION

As the global leader in precision-cut crystals, Swarovski is an active player in the worlds of jewelry, fashion, entertainment, design, and interiors. From small to large, Swarovski crystals have become an indispensable material for designers around the world, sparking inspiration, experimentation and play.

A dedication to precision and innovation has been a cornerstone of the company since its founding in 1895. This pursuit of excellence includes Swarovski's commitment

to quality and mastery of crystal-cutting but also to trend research which results in masterful modern cuts, colors, and effects—all highlighted seasonally in our comprehensive launch packages. Swarovski also offers segment-specific collections and customized product solutions, as well as personalized market insights.

For creative inspiration and further details on products and services, please contact your local Swarovski sales office.

## ORDERING

Please contact your nearest Swarovski sales office to order products. Registered customers also have the convenient option to order online via the e-commerce service at [swarovski.com/s-professionals](http://swarovski.com/s-professionals). In addition to providing an

online ordering facility, the website also includes valuable product information, availability, delivery details and much more. Contact your Swarovski sales office to register for this service.

## APPLICATION INFORMATION

Thanks to their outstanding quality and with the help of specially developed application techniques, Swarovski products can be processed easily and quickly to produce high-quality results.

The Application Manual provides in-depth information regarding all current application techniques and the technical services provided by Swarovski. It contains detailed illustrations and instructions for correct soldering, plating, gluing, sewing, embroidery, Hotfix, and mechanical application, as well as useful care instructions

and information about the required machines, tools, and aids and their suppliers. The manual is available in various international languages.

All detailed information regarding the Application Manual is also available as a free download on our business website [swarovski.com/s-professionals](http://swarovski.com/s-professionals). The application techniques are demonstrated in animations and videos. For specific questions regarding the application techniques, please contact your local Swarovski sales office.

## UNCUT AND RIMMED ARTICLES

### Uncut articles: /4

The crystals have not been cut and have no facets (e.g. art. 2080/4).

### Rimmed articles: /I

Only a part of the article is treated with an effect (e.g. art. 2078/I).

## SIZES

Various measurement abbreviations are used to classify the jewelry stones.



### PP, SS

Pearl Plate (PP), Sieve Size or Stone Size (SS) for round crystals. Please also refer to the conversion table located at the back of the collection ("Open to See Sizes").

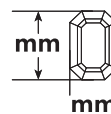

### mm

Metric measurement in millimeters.

## COLORS & EFFECTS

The assortment offers a wide range of colors, including all the classical jewelry colors. Creative grouping of the available colors can achieve combinations that are not only original but also rich in nuances.

### Colors & Effects Categories

In the product matrices, colors and effects follow a specific segmentation:

#### Please note:

Colors and effects can appear different when illuminated with different light sources. Swarovski uses standard light source D65 for color decision and comparison. Special color cards for several product groups are located at the beginning of the relevant chapters.

<b>Crystal</b>	Crystal (001), foiled or unfoiled	
<b>Colors</b>		For Crystals
<b>Plain Colors</b>	Available plain colors	
<b>Opal Colors</b>	Available opal colors	
<b>Colors</b>		For Crystal Pearls
<b>Pearl Colors</b>	Available plain colors	
<b>Pearl Gemcolors</b>	Available Gemcolors	
<b>Iridescent Pearl Colors</b>	Available Iridescent Colors	
<b>Crystal Effects or Color Effects</b>		
<b>Transparent Effects</b>	Available transparent effects	
<b>Metallic Effects</b>	Available metallic-appearance effects	
<b>Crystal Lacquer<sup>PRO</sup> Effects</b>		
<b>Crystal Lacquer<sup>PRO</sup> Ignite Effects</b>	Available Crystal Lacquer <sup>PRO</sup> Ignite effects	
<b>Crystal Lacquer<sup>PRO</sup> DeLite Effects</b>	Available Crystal Lacquer <sup>PRO</sup> DeLite effects	
<b>Crystal Electric Lacquer<sup>PRO</sup> Effects</b>	Available Crystal Electric Lacquer <sup>PRO</sup> effects	

## EFFECTS

### Vacuum Coating Effects

Vacuum coating processes on the outside of crystals produce either a special **surface** or a **translucent** effect, according to the application methods used.

Please find below a list of all Swarovski effects followed by an explanation of the special vacuum coating processes.

#### Surface Effects

(Vacuum coating on the front side of the crystals)



EFFECT CODE	NAME
AB	Aurore Boreale
ANTP	Antique Pink
BLSH	Blue Shade

CAL	Comet Argent Light
GSHA	Golden Shadow
HEM	Hematite (only on Jet)
LTCH	Light Chrome
MLGLD	Metallic Light Gold
METSH	Metallic Sunshine
MOL	Moonlight
NIFA	Nightfall
PARSH	Paradise Shine
ROGL	Rose Gold
SHIM	Shimmer
SSHA	Silver Shade
TRA	Transmission

## EFFECTS CONT.

### Translucent Effects

(Vacuum coating on the reverse side of the crystals, effect shines through the transparent crystals)



EFFECT CODE	NAME
BBL	Bermuda Blue
HEL	Heliotrope
IGNIT	Ignite
SINI	Silver Night
VL	Vitrail Light
VM	Vitrail Medium
VOL	Volcano

### Crystal Lacquer<sup>PRO</sup> Effects

A premium opaque varnish that is applied to the reverse side of the crystals instead of foiling, resulting in an opalescent appearance.

#### Crystal Lacquer<sup>PRO</sup> Ignite Effects

EFFECT CODE	NAME
001 L162I	Crystal Flamingo Ignite
001 L164I	Crystal Linen Ignite
001 L160I	Crystal Maroon Ignite
001 L159I	Crystal Orange Ignite
001 L161I	Crystal Purple Ignite
001 L163I	Crystal Sky Ignite

#### Crystal Lacquer<sup>PRO</sup> DeLite Effects

EFFECT CODE	NAME
001 L149D	Crystal Dusty Pink DeLite
001 L106D	Crystal Ivory Cream DeLite
001 L142D	Crystal Laguna DeLite
001 L144D	Crystal Lavender DeLite
001 L145D	Crystal Lotus Pink DeLite
001 L143D	Crystal Ocean DeLite
001 L146D	Crystal Orange Glow DeLite
001 L110D	Crystal Royal Blue DeLite
001 L107D	Crystal Royal Red DeLite
001 L150D	Crystal Serene Gray DeLite
001 L147D	Crystal Silky Sage DeLite

#### Crystal Electric Lacquer<sup>PRO</sup> Effects

Neon-inspired lacquer colors on Flat Backs that glow under the UV-Light

EFFECT CODE	NAME
001 L134S	Crystal Electric Blue
001 L135S	Crystal Electric Green
001 L136S	Crystal Electric Orange
001 L137S	Crystal Electric Pink
001 L148S	Crystal Electric Violet
001 L139S	Crystal Electric White
001 L138S	Crystal Electric Yellow

### Variations on Surface Effects



**2x**  
Both sides of the crystals are treated with an effect (e.g. art. 5328 AB 2x).



**B**  
Effects on three sides of a cube shape (e.g. art. 5601 AB B).



**V**  
The effect is used in reverse. A surface effect is used like a translucent effect (e.g. art. 2303 NoHF GSHA V - Golden Shadow on reverse side).



**Z**  
Only a part of the crystals is treated with an effect (e.g. art. 4869 CAVZ (Comet Argent Light V Z)).

#### CAL'V'SI & CAL'VZ'SI

The effect CAL (Comet Argent Light) effect is also used as a mirror coating on the reverse side of the crystals instead of standard foilings (A, F, etc.) in special cases.

#### /G

Article with a partly (PF) or fully frosted (FF) surface.

### Special Surface Effects

Swarovski has been able to achieve special surface effects by using special chemical and mechanical processes on the surface of the crystals.



EFFECT CODE	NAME
MAT	Matt Finish

The Matt Finish effect is achieved by performing a chemical matting process on the entire surface of the crystals. Small variations in the size of the articles may occur as a result of this chemical process.

Colors

-  Crystal 001
-  White Opal 234
-  Light Silk 261
-  Silk 391
-  Light Peach 362
-  Rosaline 508
-  Rose Water Opal 395
-  Vintage Rose 319
-  Blush Rose 257
-  Light Rose 223
-  Rose Peach 262
-  Padparadscha 542
-  Indian Pink 289
-  Rose 209
-  Fuchsia 502
-  Light Siam 227
-  Scarlet 276
-  Indian Siam 327
-  Siam 208
-  Ruby 501
-  Burgundy 515
-  Amethyst 204
-  Iris 219
-  Light Amethyst 212
-  Violet 371
-  Provence Lavender 283
-  Tanzanite 539
-  Purple Velvet 277
-  Light Azore 361
-  Aquamarine 202
-  Light Sapphire 211
-  Sapphire 206
-  Capri Blue 243
-  Majestic Blue 296
-  Cobalt 369
-  Dark Indigo 288
-  Montana 207
-  Denim Blue 266
-  Indicolite 379
-  Light Turquoise 263

Effects

-  Blue Zircon 229
-  Erinite 360
-  Chrysolite 238
-  Peridot 214
-  Citrus Green 337
-  Fern Green 291
-  Emerald 205
-  Jonquil 213
-  Light Topaz 226
-  Sunflower 292
-  Golden Topaz 1003
-  Light Colorado Topaz 246
-  Topaz 203
-  Light Amber 1002
-  Smoked Amber 1001
-  Greige 284
-  Black Diamond 215
-  Graphite 253
-  Jet 280
-  Crystal Moonlight 001 MOL
-  Crystal Shimmer 001 SHIM
-  Crystal Transmission Hotfix Transparent 001 TRA HFT
-  Crystal Aurore Boreale 001 AB
-  Crystal Antique Pink 001 ANTP
-  Crystal Vitrail Light 001 VL
-  Crystal Paradise Shine 001 PARSH
-  Crystal Vitrail Medium 001 VM
-  Crystal Volcano 001 VOL
-  Crystal Heliotrope 001 HEL
-  Crystal Bermuda Blue 001 BBL
-  Crystal Blue Shade 001 BLSH
-  Crystal Golden Shadow 001 GSHA
-  Crystal Metallic Sunshine 001 METSH
-  Crystal Rose Gold 001 ROGL
-  Crystal Metallic Light Gold 001 MLGLD
-  Crystal Light Chrome 001 LTCH
-  Crystal Comet Argent Light 001 CAL
-  Crystal Silver Shade 001 SSHA
-  Crystal Silver Night 001 SINI
-  Jet Hematite 280 HEM

## Crystal Lacquer<sup>PRO</sup> Effects







### Crystal Lacquer<sup>PRO</sup> DeLite Effects

-  Crystal Ivory Cream DeLite  
001 L106D
-  Crystal Dusty Pink DeLite  
001 L149D
-  Crystal Orange Glow DeLite  
001 L146D
-  Crystal Lotus Pink DeLite  
001 L145D
-  Crystal Royal Red DeLite  
001 L107D
-  Crystal Lavender DeLite  
001 L144D
-  Crystal Ocean DeLite  
001 L143D
-  Crystal Royal Blue DeLite  
001 L110D
-  Crystal Laguna DeLite  
001 L142D
-  Crystal Silky Sage DeLite  
001 L147D
-  Crystal Serene Gray DeLite  
001 L150D























### Crystal Lacquer<sup>PRO</sup> Ignite Effects

-  Crystal Linen Ignite  
001 L164I
-  Crystal Flamingo Ignite  
001 L162I
-  Crystal Orange Ignite  
001 L159I
-  Crystal Maroon Ignite  
001 L160I
-  Crystal Purple Ignite  
001 L161I
-  Crystal Sky Ignite  
001 L163I

### Crystal Electric Lacquer<sup>PRO</sup> Effects



















-  Crystal Electric White  
001 L139S
-  Crystal Electric Orange  
001 L136S
-  Crystal Electric Pink  
001 L137S
-  Crystal Electric Violet  
001 L148S
-  Crystal Electric Blue  
001 L134S
-  Crystal Electric Green  
001 L135S
-  Crystal Electric Yellow  
001 L138S

## Shimmer Effects







-  White Opal Shimmer  
234 SHIM
-  Silk Shimmer  
391 SHIM
-  Rose Water Opal Shimmer  
395 SHIM
-  Light Rose Shimmer  
223 SHIM
-  Rose Shimmer  
209 SHIM
-  Fuchsia Shimmer  
502 SHIM
-  Light Siam Shimmer  
227 SHIM
-  Scarlet Shimmer  
276 SHIM
-  Siam Shimmer  
208 SHIM
-  Amethyst Shimmer  
204 SHIM
-  Light Amethyst Shimmer  
212 SHIM
-  Tanzanite Shimmer  
539 SHIM
-  Aquamarine Shimmer  
202 SHIM
-  Light Sapphire Shimmer  
211 SHIM
-  Blue Zircon Shimmer  
229 SHIM
-  Erinite Shimmer  
360 SHIM
-  Peridot Shimmer  
214 SHIM
-  Emerald Shimmer  
205 SHIM
-  Light Topaz Shimmer  
226 SHIM
-  Light Colorado Topaz Shimmer  
246 SHIM
-  Topaz Shimmer  
203 SHIM
-  Black Diamond Shimmer  
215 SHIM
-  Jet Shimmer  
280 SHIM



## AB Effects

-  Light Rose Aurore Boreale  
223 AB
-  Rose Aurore Boreale  
209 AB
-  Fuchsia Aurore Boreale  
502 AB
-  Light Siam Aurore Boreale  
227 AB
-  Siam Aurore Boreale  
208 AB
-  Amethyst Aurore Boreale  
204 AB
-  Iris Aurore Boreale  
219 AB2
-  Violet Aurore Boreale  
371 AB
-  Purple Velvet Aurore Boreale  
277 AB
-  Aquamarine Aurore Boreale  
202 AB
-  Light Sapphire Aurore Boreale  
211 AB
-  Sapphire Aurore Boreale  
206 AB
-  Capri Blue Aurore Boreale  
243 AB
-  Blue Zircon Aurore Boreale  
229 AB
-  Peridot Aurore Boreale  
214 AB
-  Fern Green Aurore Boreale  
291 AB
-  Jonquil Aurore Boreale  
213 AB
-  Light Topaz Aurore Boreale  
226 AB
-  Jet Aurore Boreale  
280 AB

## Ignite Effects

-  Crystal Ignite  
001 IGNIT
-  Light Rose Ignite  
223 IGNIT
-  Scarlet Ignite  
276 IGNIT
-  Amethyst Ignite  
204 IGNIT
-  Aquamarine Ignite  
202 IGNIT
-  Emerald Ignite  
205 IGNIT
-  Light Colorado Topaz Ignite  
246 IGNIT

## Nightfall Effects

-  Siam Nightfall  
208 NIFA
-  Capri Blue Nightfall  
243 NIFA
-  Emerald Nightfall  
205 NIFA
-  Graphite Nightfall  
253 NIFA

## Cabochons

-  Crystal White Pearl  
001 650
-  Crystal Nacre  
001 191
-  Crystal Creampearl  
001 291
-  Crystal Golden Shadow  
001 GSHA
-  Crystal Rosaline Pearl  
001 294
-  Crystal Dark Grey Pearl  
001 617
-  Jet  
280
-  Jet Hematite  
280 HEM

## Rimmed Flat Backs

-  Jet Light Chrome Z  
280 LTCHZ

## FOILING

Foiling is the process of mirror coating the reverse side of the crystals.



### Silver Foiling (A)

A silver mirror finish for XIRIUS and XILION Hotfix articles only.



### Platinum\* PRO Foiling (F)

A silver mirror finish that is coated with a platinum-colored protective layer of the highest quality (e.g. art. 4120).



### Aluminum Foiling (M)

An aluminum mirror finish is applied using a vacuum coating process (e.g. art. 2303 Flat Back HF).



### Protective Layer (P) for Beads and Pendants

Protective layer is a transparent lacquer system that is applied over the effects. This lacquer is designed to protect the effects from scratches, fingerprints, and other damage, and also helps to prevent moisture that can lead to corrosion (e.g. perspiration) penetrating into the effect layer when jewelry is designed to incorporate Crystal Stones that are not set in casings/settings.



### Unfoiled (U)

## HOTFIX TECHNOLOGY

### Hotfix (HF)

Hotfix technology involves applying specially developed glue onto the reverse side of Flat Backs. The glue is extremely flexible and is activated at a temperature of 120°C, with the option of being applied up to 170°C. It bonds with the carrier material and the crystals become permanently fixed during cooling.

### Hotfix Transparent (HFT)

This variant of the Hotfix technology is a patented bonding agent that is applied to the reverse side of

non-mirror-finished Flat Backs, resulting in an interesting "raindrop" effect in which the crystals take on the color of the carrier material.

This transparent bonding agent is also used with Crystal Lacquer<sup>PRO</sup> effects on Flat Backs.

### No Hotfix (No HF)

Flat Back articles are also available as No Hotfix articles with no glue on the reverse side. For more information please contact your local Swarovski sales office.

## DISCLAIMER

The material manufactured by Swarovski is considered as "crystal glass", category 3, in accordance with European Council Directive 69/493 on the approximation of the laws of the Member States relating to crystal glass. Whenever referring to "crystal" in this document, Swarovski either refers to a singular component or product made of crystal glass, or the material crystal glass.

\* Silver mirror coated with a platinum-colored protective layer.

## LAWS, REGULATIONS, NORMS, AND STANDARDS

The composition of loose and forward-integrated crystals in the Advanced Crystal standard is compliant with regulatory industry norms and laws regarding the restriction or prohibition of certain substances for finished

products in the most relevant segments of our customers' businesses. Further information can be found at [swarovski.com/s-professionals](http://swarovski.com/s-professionals).

## WARNING NOTICES

### General Warning

Loose crystals may present a small parts hazard to young children, particularly children under three years old. Depending on the size of the crystals and any attached material (such as glue, fabric, etc.), children may choke on, inhale, swallow, or insert the crystals into their noses. Magnetic products with crystal applications pose a particular risk of serious intestinal injury if ingested. The application techniques as stated in the Application Manual do not guarantee that crystals will not come loose or chip. For each application, the manufacturer must determine whether the product meets the relevant requirements related to small parts hazards and assess any risk it may pose, in particular to small children. Failure to follow Swarovski's care instructions may result in damage to the crystals, which could pose a risk of laceration or other harm.

### Warning for Tableware

The application of loose crystals to tableware presents a potential risk of aspiration, choking, swallowing, or tooth damage should crystals become loose. To reduce this risk, crystals should never be applied to any surface of tableware likely to come in contact with food or the mouth, and crystals should never be placed on any tableware intended for use by children. Tableware with crystals intended for decorative use only should be marked as such. To avoid dishwasher damage, tableware decorated with crystals should be washed by hand. The application techniques or suggestions in this manual do not guarantee that crystals will not come loose. For each application, the manufacturer must determine whether the product meets relevant requirements related to small parts hazards or use in food contact items and assess any risk it may pose to users. The use of crystals (which may contain restricted substances deemed hazardous under local laws) and adhesives on tableware is subject to legal restrictions in specific countries. The customer is fully responsible for complying with these country-specific provisions and shall defend, indemnify, and hold Swarovski harmless from any and all third-party claims based on product liability or otherwise relating to uses of Swarovski products, and waives all its own claims against Swarovski.

### Unsuitable Applications

Crystals from Swarovski are intended for use in the fields of fashion, jewelry, accessories, textile products, and for interior décor. Due to their physical properties, crystals from Swarovski are unsuitable for other uses (e.g. gluing onto teeth, using on or near mucous membranes, and other unsafe uses). The customer shall defend, indemnify, and hold Swarovski harmless from any and all third-party claims based on product liability or otherwise relating to uses of Swarovski products purchased by the customer, and waives all its own claims.

### Responsibility of User

Failure to follow Swarovski's care instructions may result in damage to the crystals, which could pose a risk of laceration or other harm.

Any verbal, written, or test-based advice that Swarovski provides regarding techniques for the application of its products is a recommendation based on Swarovski's current knowledge and the information provided by its suppliers. Such advice does not discharge the customer from carrying out its own tests of techniques it proposes to use and their suitability for the intended application. The application, use, and processing of these techniques and products are solely the user's responsibility.

### Change of Product

Swarovski reserves the right to modify the dimensions, shape, composition and concentration of components belonging to products that are referred to in this Product Information brochure. Furthermore, any applicable laws and regulations mentioned are subject to change, which is why Swarovski regularly publishes an updated version of the Product Information brochure containing facts, (application) instructions, and the current legal situation that is valid at the time of publication. References to compliance with such regulations as are stated above are based on their requirements as of the current date. Anyone seeking an in-depth understanding of the provisions should read the various laws in their entirety and/or seek advice from a legal counsel.







The customer must request and observe the valid version of the Product Information brochure before (re)ordering and using the products.



# Care Instructions

To ensure the highest quality and long-lasting applications of Swarovski products, proper care is essential.

# Textile Care Instructions

							
GENERAL RECOMMENDATIONS		Turn inside out, choose a gentle wash cycle and use mild laundry detergent.			Turn inside out and use mild laundry detergent.**	Do not wash!	Chlorine bleach may be used.
		To protect the crystals as much as possible, the use of a soft wash bag is recommended.					
Round Stones		✓					
Flat Backs No Hotfix <sup>1</sup>		✓					
Flat Backs Hotfix	XILION Rose, XIRIUS Rose <sup>1</sup> & Creation Stones	✓					✓
	Creation Stones Plus <sup>2</sup>				✓		✓
	Cabochons		✓				✓
Sew-on Articles & Crystal Buttons	Sew-on Articles	✓***			✓		
	Crystal Buttons	✓					
Fancy Stones		✓					
Beads		✓					
Crystal Pearls				✓	✓		
Pendants						✓	
Crystal Transfers	XILION Transfers, XIRIUS Transfers <sup>1</sup> , Framed Flat Back Transfers, Creation Transfers & Crystal Diamond Transfers	✓					
	Creation Transfers Plus <sup>2</sup>				✓		
	Mezzo Transfers		✓				
	Cabochon Transfers		✓				
Crystal Textures Hotfix (+Lacquered Textures)	Crystal Fabric		✓				
	Crystal Intarsia		✓		✓		
	Crystal Rocks, Crystal Fine Rocks & Crystal Ultrafine Rocks		✓				
	Graphic Fabric, Graphic Rocks, Graphic Fine Rocks & Graphic Ultrafine Rocks			✓****	✓		
	Crystaltex Chaton Bandings		✓				
	Crystal Textures Self Adhesive Elements (+ Lacquered Textures)	Crystal Fabric-it, Crystal Intarsia-it, Crystaltex Chaton-it, Crystal Rocks-it, Crystal Fine Rocks-it & Crystal Ultrafine Rocks-it					✓
Crystal Fabric Coldfix, Crystal Intarsia Coldfix, Crystal Rocks Coldfix, Crystal Fine Rocks Coldfix & Ultrafine Rocks Coldfix					✓		
Linked Crystal Components	Crystal Mesh Standard & Crystal Fine Mesh				✓		
	Fishnet Bandings		✓				
	Flat Back Bandings				✓		
	Cupchains					✓	
Crystal Rivets & Rose Pins	Crystal Rivet		✓				
	Rose Pins		✓				

\* Colors are machine washable at 60°C (140°F). Please take note of the general care instructions in the Application Manual dependent on the product groups where the colors are applied. Swarovski effects are only washable with 40°C (104°F) maximum.

\*\* Wash by hand: max. temperature 30°C (86°F), very mild process.





<sup>1</sup> XIRIUS size SS40 and SS48: only wash on a hand wash program.

<sup>2</sup> Creation Stones Plus have a stone size starting at 8 mm and/or a height starting at 4 mm.

\*\*\* Sew-on Articles 28 mm and above: Wash by hand





\*\*\*\* Please check the appropriate Product Information for Graphic as the washing parameters are different between Graphic Foil print and Graphic Glass print.

# Textile Care Instructions

						
		Do not use chlorine bleach!	Turn inside out and dry at reduced temperature.	Do not tumble dry!	Iron inside out using a silk/polyester/viscose setting. Ironing the textile inside out and using a pressing cloth is recommended.	Iron inside out using a wool setting.
<b>Round Stones</b>		✓		✓		
<b>Flat Backs No Hotfix<sup>1</sup></b>		✓		✓		
<b>Flat Backs Hotfix</b>	XILION Rose, XIRIUS Rose <sup>1</sup> , Framed Flat Backs & Creation Stones	✓	✓		✓	
	Creation Stones Plus <sup>2</sup>	✓		✓		
	Cabochons	✓	✓		✓	
<b>Sew-on Articles &amp; Crystal Buttons</b>	Sew-on Articles	✓		✓		
	Crystal Buttons	✓		✓		
<b>Fancy Stones</b>		✓		✓		
<b>Beads</b>		✓	✓			
<b>Crystal Pearls</b>		✓		✓		
<b>Pendants</b>		✓		✓		
<b>Crystal Transfers</b>	XILION Transfers, XIRIUS Transfers <sup>1</sup> , Framed Flat Back Transfers, Creation Transfers & Crystal Diamond Transfers	✓	✓		✓	
	Creation Transfers Plus <sup>2</sup>	✓		✓		
	Mezzo Transfers	✓		✓	✓	
	Cabochon Transfers	✓	✓		✓	
<b>Crystal Textures Hotfix</b>	Crystal Fabric	✓		✓	✓	
	Crystal Intarsia	✓		✓	✓	
	Crystal Rocks, Crystal Fine Rocks & Crystal Ultrafine Rocks	✓		✓	✓	
	Graphic Fabric, Graphic Rocks, Graphic Fine Rocks & Graphic Ultrafine Rocks	✓		✓	✓	
	Crystaltex Chaton Bandings	✓		✓	✓	
<b>Crystal Textures Self Adhesive Elements</b>	Crystal Fabric-it, Crystal Intarsia-it, Crystaltex Chaton-it, Crystal Rocks-it, Crystal Fine Rocks-it & Crystal Ultrafine Rocks-it					
	Crystal Fabric Coldfix, Crystal Intarsia Coldfix, Crystal Rocks Coldfix, Crystal Fine Rocks Coldfix & Ultrafine Rocks Coldfix	✓		✓		
<b>Linked Crystal Components</b>	Crystal Mesh Standard & Crystal Fine Mesh	✓		✓		
	Fishnet Bandings		✓			
	Flat Back Bandings	✓		✓		
	Cupchains	✓		✓		
<b>Crystal Studs &amp; Rivets</b>	Crystal Rivets	✓		✓		
	Rose Pins	✓		✓		

<sup>1</sup> XIRIUS size SS 40 and SS 48: only wash on a hand wash program.

<sup>2</sup> Creation Stones Plus have a stone size starting at 8 mm and/or a height starting at 4 mm.

						
		Do not iron!	The textile can be gently dry-cleaned using perchlorethylene. Turn inside out.	The textile can be gently dry-cleaned using hydrocarbon. Turn inside out.	The textile will withstand gentle professional wet cleaning. Turn inside out.	The textile may not be dry-cleaned.
		To protect the crystals as much as possible, the use of a soft wash bag is recommended.				
<b>Round Stones</b>		✓		✓	✓	
<b>Flat Backs No Hotfix<sup>1</sup></b>		✓		✓	✓	
<b>Flat Backs Hotfix</b>	XILION Rose, XIRIUS Rose <sup>1</sup> , Framed Flat Backs & Creation Stones		✓	✓	✓	
	Creation Stones Plus <sup>2</sup>	✓	✓	✓	✓	
	Cabochons		✓	✓	✓	
<b>Sew-on Articles &amp; Crystal Buttons</b>	Sew-on Articles	✓	✓	✓	✓	
	Crystal Buttons	✓	✓	✓	✓	
<b>Fancy Stones</b>		✓		✓	✓	
<b>Beads</b>		✓	✓	✓	✓	
<b>Crystal Pearls</b>		✓	✓	✓	✓	
<b>Pendants</b>		✓				✓
<b>Crystal Transfers</b>	XILION Transfers, XIRIUS Transfers <sup>1</sup> , Framed Flat Back Transfers, Creation Transfers & Crystal Diamond Transfers		✓	✓	✓	
	Creation Transfers Plus <sup>2</sup>	✓	✓	✓	✓	
	Mezzo Transfers			✓	✓	
	Cabochon Transfers		✓	✓	✓	
<b>Crystal Textures Hotfix</b>	Crystal Fabric				✓	
	Crystal Intarsia				✓	
	Crystal Rocks, Crystal Fine Rocks & Crystal Ultrafine Rocks				✓	
	Graphic Fabric, Graphic Rocks, Graphic Fine Rocks & Graphic Ultrafine Rocks				✓	
	Crystaltex Chaton Bandings				✓	
<b>Crystal Textures Self Adhesive Elements</b>	Crystal Fabric-it, Crystal Intarsia-it, Crystaltex Chaton-it, Crystal Fine Rocks-it, Crystal Fine Rocks-it & Crystal Ultrafine Rocks-it					
	Crystal Fabric Coldfix, Crystal Intarsia Coldfix, Crystal Rocks Coldfix, Crystal Fine Rocks Coldfix & Ultrafine Rocks Coldfix	✓			✓	
<b>Linked Crystal Components</b>	Crystal Mesh Standard & Crystal Fine Mesh	✓		✓	✓	
	Fishnet Bandings	✓	✓	✓	✓	
	Flat Back Bandings	✓		✓	✓	
	Cupchains	✓				✓
<b>Crystal Studs &amp; Rivets</b>	Crystal Rivets	✓	✓	✓	✓	
	Rose Pins	✓	✓	✓	✓	

1 XIRIUS size SS 40 and SS 48: only wash on a hand wash program.

2 Creation Stones Plus have a stone size starting at 8 mm and/or a height starting at 4 mm.



## General Care Instructions

A light layer of dust is most easily removed with a clean, dry, antistatic cloth. It is best to also wear white cotton gloves so as to avoid unsightly fingerprints. For heavier dirt, lukewarm water with a little dishwashing detergent will suffice. Ideally you should use a clean microfiber or thin, lint-free cotton cloth that has been wrung out as much as possible.



Cloth

Not following Swarovski care instructions can damage the product and thus lead to damage of textiles or other damage.

Please note that with all standard washing processes (whether carried out by a household washing machine or via dry cleaning) the rotation of the drum places significant mechanical forces on the textiles. The most important factor in ensuring a secure wash is correctly applying the product, without compromising its adhesion. The larger the product employed, and the more products are applied next to each other, the greater the risk of damage. Swarovski products are made out of crystal or contain crystal and must thus be handled with suitable care.

In general it is recommended that a soft wash bag is used and that the washer drum is filled to protect against damage.

To maintain the quality of crystals from Swarovski, the following is also important:

Before washing, turn items of clothing inside out, select a gentle wash cycle, and use a mild detergent.

Gently wipe each individual crystal and dry with a clean cloth. It is best to wear white cotton gloves here as well.

Please ensure that when cleaning with moisture, only cleaning agents that do not damage the surrounding material are used. By correctly cleaning your Swarovski crystals, you will restore the full reflectivity.

According to DIN EN ISO 3758, our care instructions list all product groups, meaning each product used by customers must be assessed separately with regard to its washability and suitability for its purpose/the end product. The recommendations given by Swarovski reflect our current level of knowledge. Swarovski uses these recommendations to decide on the suitability of the product for textile applications.

Customers are solely responsible for defining the recommended cleaning processes for the end product, and must consider the care advice of Swarovski and any other manufacturers in doing so.

The type of shape, cut, surface effect, and size, as well as the weight of the application and the quantity of crystals used has a significant impact on the cleaning process to be followed.

To avoid all risks, customers/textile cleaning companies should remove any large crystals (elements, buttons, etc...), that have been stitched on before cleaning, and stitch them back on again afterwards.



# Components Collection



ROUND STONES	01
FLAT BACKS NO HOTFIX	02
FLAT BACKS HOTFIX	03
SEW-ON ARTICLES & CRYSTAL BUTTONS	04
FANCY STONES	05
BEADS	06
CRYSTAL PEARLS	07
PENDANTS	08
CRYSTAL TRANSFERS	09
CRYSTAL TEXTURES	10
LINKED CRYSTAL COMPONENTS	11
CRYSTAL RIVETS & ROSE PINS	12
APPLICATION TOOLS	13



# Round Stones

Round Stones are incredibly versatile, loose elements, with many possessing a pointed reverse side allowing for effortless application in pre-set cavities or metal claws. Featuring various cuts, and an extensive range of sizes, the assortment encompasses the XERO Chaton, the smallest existing size, and the innovative XIRIUS Chaton, renowned for its unparalleled brilliance in a celebration of high art and technical expertise.

Merging a gemstone-inspired cut with richly varied colors, and PlatinumPRO colored foiling for exceptional durability, XIRIUS ensures crystals come one step closer to a diamond.







## Colors & Effects

OPEN TO SEE COLORS & EFFECTS

## Colors

-  Crystal 001
-  White Opal 234
-  Silk 391
-  Vintage Rose 319
-  Light Rose 223
-  Rose Peach 262
-  Rose 209
-  Light Siam 227
-  Scarlet 276
-  Siam 208
-  Amethyst 204
-  Iris 219
-  Light Amethyst 212
-  Violet 371
-  Tanzanite 539
-  Aquamarine 202
-  Light Sapphire 211
-  Sapphire 206
-  Montana 207
-  Denim Blue 266
-  Light Turquoise 263
-  Chrysolite 238
-  Peridot 214
-  Citrus Green 337
-  Emerald 205
-  Light Topaz 226
-  Golden Topaz 1003
-  Light Colorado Topaz 246
-  Light Amber 1002
-  Smoked Amber 1001
-  Greige 284
-  Black Diamond 215
-  Jet 280

## Effects

-  Crystal Moonlight 001 MOL
-  Crystal Aurore Boreale 001 AB
-  Crystal Golden Shadow 001 GSHA
-  Crystal Silver Shade 001 SSHA
-  Crystal Silver Night 001 SINI
-  Jet Hematite 280 HEM

## Crystal Lacquer<sup>PRO</sup> Effects







### Crystal Lacquer<sup>PRO</sup> DeLite Effects

-  Crystal Ivory Cream DeLite 001 L106D
-  Crystal Dusty Pink DeLite 001 L149D
-  Crystal Orange Glow DeLite 001 L146D
-  Crystal Lotus Pink DeLite 001 L145D
-  Crystal Royal Red DeLite 001 L107D
-  Crystal Lavender DeLite 001 L144D
-  Crystal Ocean DeLite 001 L143D
-  Crystal Royal Blue DeLite 001 L110D
-  Crystal Laguna DeLite 001 L142D
-  Crystal Silky Sage DeLite 001 L147D
-  Crystal Serene Gray DeLite 001 L150D

### Crystal Lacquer<sup>PRO</sup> Ignite Effects

-  Crystal Linen Ignite 001 L164I
-  Crystal Flamingo Ignite 001 L162I
-  Crystal Orange Ignite 001 L159I
-  Crystal Maroon Ignite 001 L160I
-  Crystal Purple Ignite 001 L161I
-  Crystal Sky Ignite 001 L163I

## Ignite Effects

-  Crystal Ignite 001 IGNIT
-  Light Rose Ignite 223 IGNIT
-  Scarlet Ignite 276 IGNIT
-  Amethyst Ignite 204 IGNIT
-  Aquamarine Ignite 202 IGNIT
-  Emerald Ignite 205 IGNIT
-  Light Colorado Topaz Ignite 246 IGNIT

## Numerical Order

001	Crystal	001 MOL	Crystal Moonlight	227	Light Siam
001 AB	Crystal Aurore Boreale	001 SINI	Crystal Silver Night	234	White Opal
001 GSHA	Crystal Golden Shadow	001 SSHA	Crystal Silver Shade	238	Chrysolite
001 IGNIT	Crystal Ignite	202 IGNIT	Aquamarine Ignite	246 IGNIT	Light Colorado Topaz Ignite
001 LI06D	Crystal Ivory Cream DeLite	202	Aquamarine	246	Light Colorado Topaz
001 LI07D	Crystal Royal Red DeLite	204 IGNIT	Amethyst Ignite	262	Rose Peach
001 LI10D	Crystal Royal Blue DeLite	204	Amethyst	263	Light Turquoise
001 LI42D	Crystal Laguna DeLite	205 IGNIT	Emerald Ignite	266	Denim Blue
001 LI43D	Crystal Ocean DeLite	205	Emerald	276 IGNIT	Scarlet Ignite
001 LI44D	Crystal Lavender DeLite	206	Sapphire	276	Scarlet
001 LI45D	Crystal Lotus Pink DeLite	207	Montana	280 HEM	Jet Hematite
001 LI46D	Crystal Orange Glow DeLite	208	Siam	280	Jet
001 LI47D	Crystal Silky Sage DeLite	209	Rose	284	Greige
001 LI49D	Crystal Dusty Pink DeLite	211	Light Sapphire	319	Vintage Rose
001 LI50D	Crystal Serene Gray DeLite	212	Light Amethyst	337	Citrus Green
001 LI59I	Crystal Orange Ignite	214	Peridot	371	Violet
001 LI60I	Crystal Maroon Ignite	215	Black Diamond	391	Silk
001 LI61I	Crystal Purple Ignite	219	Iris	539	Tanzanite
001 LI62I	Crystal Flamingo Ignite	223 IGNIT	Light Rose Ignite	1001	Smoked Amber
001 LI63I	Crystal Sky Ignite	223	Light Rose	1002	Light Amber
001 LI64I	Crystal Linen Ignite	226	Light Topaz	1003	Golden Topaz

## Alphabetical Order

Amethyst (204)	Crystal Orange Glow DeLite (001 LI46D)	Light Colorado Topaz Ignite (246 IGNIT)
Amethyst Ignite (204 IGNIT)	Crystal Orange Ignite (001 LI59I)	Light Rose (223)
Aquamarine (202)	Crystal Purple Ignite (001 LI61I)	Light Rose Ignite (223 IGNIT)
Aquamarine Ignite (202 IGNIT)	Crystal Royal Blue DeLite (001 LI10D)	Light Sapphire (211)
Black Diamond (215)	Crystal Royal Red DeLite (001 LI07D)	Light Siam (227)
Chrysolite (238)	Crystal Serene Gray DeLite (001 LI50D)	Light Topaz (226)
Citrus Green (337)	Crystal Silky Sage DeLite (001 LI47D)	Light Turquoise (263)
Crystal (001)	Crystal Silver Night (001 SINI)	Montana (207)
Crystal Aurore Boreale (001 AB)	Crystal Silver Shade (001 SSHA)	Peridot (214)
Crystal Dusty Pink DeLite (001 LI49D)	Crystal Sky Ignite (001 LI63I)	Rose (209)
Crystal Flamingo Ignite (001 LI62I)	Denim Blue (266)	Rose Peach (262)
Crystal Golden Shadow (001 GSHA)	Emerald (205)	Sapphire (206)
Crystal Ignite (001 IGNIT)	Emerald Ignite (205 IGNIT)	Scarlet (276)
Crystal Ivory Cream DeLite (001 LI06D)	Golden Topaz (1003)	Scarlet Ignite (276 IGNIT)
Crystal Laguna DeLite (001 LI42D)	Greige (284)	Siam (208)
Crystal Lavender DeLite (001 LI44D)	Iris (219)	Silk (391)
Crystal Linen Ignite (001 LI64I)	Jet (280)	Smoked Amber (1001)
Crystal Lotus Pink DeLite (001 LI45D)	Jet Hematite (280 HEM)	Tanzanite (539)
Crystal Maroon Ignite (001 LI60I)	Light Amber (1002)	Vintage Rose (319)
Crystal Moonlight (001 MOL)	Light Amethyst (212)	Violet (371)
Crystal Ocean DeLite (001 LI43D)	Light Colorado Topaz (246)	White Opal (234)

For details on available colors and effects for each article within the product groups, please see the product matrix of the respective item in the Collection 2023.

The plating resistance of effects is tested according to Swarovski's plating guidelines (SWAROVSKI.COM/S-PROFESSIONALS). Customers are advised to carry out their own tests if their plating parameters diverge from Swarovski plating guidelines.

Colors and effects can appear different when illuminated with different light sources. Swarovski uses standard light source D65 for color decision and comparison. Slight changes in shades are unavoidable. Colors may vary according to cut and foiling.

The composition of Advanced Crystal is compliant with regulatory industry norms and laws regarding the restriction or prohibition of certain substances in the most relevant segments of our customers. Please note that the compliance of the colors Light Siam and Siam varies according to certain industry regulations. Those regulations are indicated with \* in the compliance overview. Indian Siam, Ruby and Scarlet (option to Lt. Siam) conform to all CLEAR-lists. For further information please visit [swarovski.com/s-professionals](https://www.swarovski.com/s-professionals)

© 2023 D. Swarovski Distribution GmbH

# Summary

1 2 3

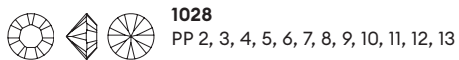

**1028**  
PP 2, 3, 4, 5, 6, 7, 8, 9, 10, 11, 12, 13

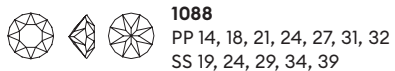

**1088**  
PP 14, 18, 21, 24, 27, 31, 32  
SS 19, 24, 29, 34, 39

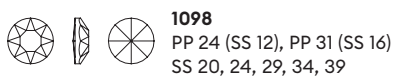

**1098**  
PP 24 (SS 12), PP 31 (SS 16)  
SS 20, 24, 29, 34, 39



**1100**  
PP 1



**1122**  
SS 39, 47  
12, 14 mm



**1383**  
8, 10, 14 mm



**1400**  
10, 12, 14, 18 mm



**1401**  
8, 10, 11.8 mm

**1100 XERO** Chaton

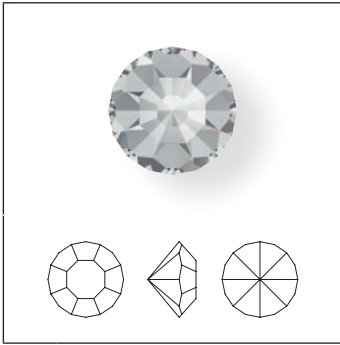

**Size** PP 1

**1028 XILION** Chaton

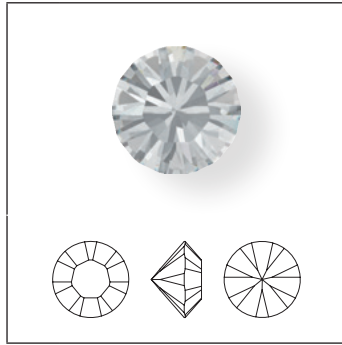

**Size** PP 2, 3, 4, 5, 6, 7, 8, 9, 10, 11, 12, 13

**1088 XIRIUS** Chaton

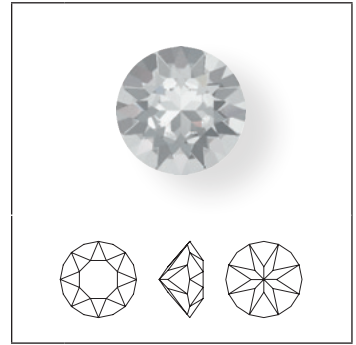

**Size** PP 14, 18, 21, 24, 27, 31, 32  
SS 19, 24, 29, 34, 39

	PP 1	PP 2	PP 3	PP 4	PP 5	PP 6	PP 7	PP 8	PP 9	PP 10	PP 11	PP 12	PP 13	PP 14	PP 18	PP 21	PP 24	PP 27	PP 31	PP 32	SS 19	SS 24	SS 29	SS 34	SS 39
<b>Crystal</b>																									
Crystal F (001)	■	■	■	■	■	■	■	■	■	■	■	■	■	■	■	■	■	■	■	■	■	■	■	■	■
<b>Colors</b>																									
<b>Plain Colors</b>																									
Amethyst F (204)		■	■	■	■	■	■	■	■	■	■	■	■	■	■	■	■	■	■	■	■	■	■	■	■
Aquamarine F (202)	■	■	■	■	■	■	■	■	■	■	■	■	■	■	■	■	■	■	■	■	■	■	■	■	■
Black Diamond F (215)	■	■	■	■	■	■	■	■	■	■	■	■	■	■	■	■	■	■	■	■	■	■	■	■	■
Chrysolite F (238)		■	■	■	■	■	■	■	■	■	■	■	■	■	■	■	■	■	■	■	■	■	■	■	■
Citrus Green F (337)														■	■	■	■	■	■	■	■	■	■	■	■
Denim Blue F (266)		■	■	■	■	■	■	■	■	■	■	■	■	■	■	■	■	■	■	■	■	■	■	■	■
Emerald F (205)		■	■	■	■	■	■	■	■	■	■	■	■	■	■	■	■	■	■	■	■	■	■	■	■
Golden Topaz F (1003)*		■	■	■	■	■	■	■	■	■	■	■	■	■	■	■	■	■	■	■	■	■	■	■	■
Greige F (284)		■	■	■	■	■	■	■	■	■	■	■	■	■	■	■	■	■	■	■	■	■	■	■	■
Iris F (219)		■	■	■	■	■	■	■	■	■	■	■	■	■	■	■	■	■	■	■	■	■	■	■	■
Jet (280)		■	■	■	■	■	■	■	■	■	■	■	■	■	■	■	■	■	■	■	■	■	■	■	■
Jet F (280)	■	■	■	■	■	■	■	■	■	■	■	■	■	■	■	■	■	■	■	■	■	■	■	■	■
Light Amber F (1002)*		■	■	■	■	■	■	■	■	■	■	■	■	■	■	■	■	■	■	■	■	■	■	■	■
Light Amethyst F (212)		■	■	■	■	■	■	■	■	■	■	■	■	■	■	■	■	■	■	■	■	■	■	■	■
Light Colorado Topaz F (246)	■	■	■	■	■	■	■	■	■	■	■	■	■	■	■	■	■	■	■	■	■	■	■	■	■
Light Rose F (223)	■	■	■	■	■	■	■	■	■	■	■	■	■	■	■	■	■	■	■	■	■	■	■	■	■

\* All colors with a 4-digit color code (i.e. Golden Topaz) are fully customizable with shorter lead times and lower MOQs compared to our 3-digit colors. Please get in touch with the Customer Service for a time and quantity estimation of your desired variant.

	Size	PP 1	PP 2	PP 3	PP 4	PP 5	PP 6	PP 7	PP 8	PP 9	PP 10	PP 11	PP 12	PP 13	PP 14	PP 18	PP 21	PP 24	PP 27	PP 31	PP 32	SS 19	SS 24	SS 29	SS 34	SS 39	
<b>1100</b>																											
<b>1028</b>																											
<b>1088</b>																											
Light Sapphire F (211)																											
Light Siam F (227)																											
Light Topaz F (226)																											
Light Turquoise F (263)																											
Montana F (207)																											
Peridot F (214)																											
Rose F (209)																											
Rose Peach F (262)																											
Sapphire F (206)																											
Scarlet F (276)																											
Siam F (208)																											
Silk F (391)																											
Smoked Amber F (1001)*																											
Tanzanite F (539)																											
Vintage Rose F (319)																											
Violet F (371)																											
<b>Opal Colors</b>																											
White Opal F (234)																											
<b>Crystal Effects</b>																											
<b>Transparent Effects</b>																											
Crystal Aurore Boreale F (001 AB)																											
Crystal Golden Shadow F (001 GSHA)																											
Crystal Ignite (001 IGNIT)																											
Crystal Moonlight F (001 MOL)																											
Crystal Silver Night F (001 SINI)																											
Crystal Silver Shade F (001 SSHA)																											
<b>Crystal Lacquer<sup>PRO</sup> Effects</b>																											
<b>Crystal Lacquer<sup>PRO</sup> Ignite Effects</b>																											
Crystal Flamingo Ignite (001 L162I)																											
Crystal Linen Ignite (001 L164I)																											
Crystal Maroon Ignite (001 L160I)																											
Crystal Orange Ignite (001 L159I)																											
Crystal Purple Ignite (001 L161I)																											
Crystal Sky Ignite (001 L163I)																											

\* All colors with a 4-digit color code (i.e. Golden Topaz) are fully customizable with shorter lead times and lower MOQs compared to our 3-digit colors. Please get in touch with the Customer Service for a time and quantity estimation of your desired variant.

	Size																										
	PP 1	PP 2	PP 3	PP 4	PP 5	PP 6	PP 7	PP 8	PP 9	PP 10	PP 11	PP 12	PP 13	PP 14	PP 18	PP 21	PP 24	PP 27	PP 31	PP 32	SS 19	SS 24	SS 29	SS 34	SS 39		
<b>1100</b> <b>1028</b> <b>1088</b>																											
<b>Crystal Lacquer<sup>PRO</sup> DeLite Effects</b>																											
Crystal Dusty Pink DeLite (001 L149D)																											
Crystal Ivory Cream DeLite (001 L106D)																											
Crystal Laguna DeLite (001 L142D)																											
Crystal Lavender DeLite (001 L144D)																											
Crystal Lotus Pink DeLite (001 L145D)																											
Crystal Ocean DeLite (001 L143D)																											
Crystal Orange Glow DeLite (001 L146D)																											
Crystal Royal Blue DeLite (001 L110D)																											
Crystal Royal Red DeLite (001 L107D)																											
Crystal Serene Gray DeLite (001 L150D)																											
Crystal Silky Sage DeLite (001 L147D)																											
<b>Color Effects</b>																											
<b>Transparent Effects</b>																											
Amethyst Ignite (204 IGNIT)																											
Aquamarine Ignite (204 IGNIT)																											
Emerald Ignite (205 IGNIT)																											
Light Colorado Topaz Ignite (246 IGNIT)																											
Light Rose Ignite (223 IGNIT)																											
Scarlet Ignite (276 IGNIT)																											
<b>Color Effects</b>																											
<b>Metallic Effects</b>																											
Jet Hematite F (280 HEM)																											



1098 XIRIUS Light

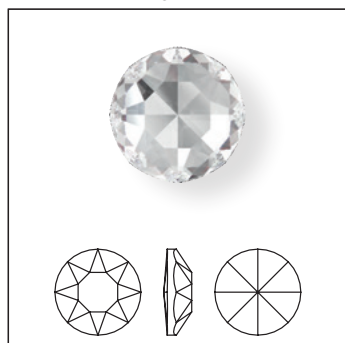

Size	PP 24	PP 31	SS 20	SS 24	SS 29	SS 34	SS 39
------	-------	-------	-------	-------	-------	-------	-------

**Crystal**

Crystal F (001)

**Crystal Effects**

**Transparent Effects**

Crystal Aurore Boreale F (001 AB)

Crystal Golden Shadow F (001 GSHA)

Crystal Silver Night F (001 SINI)

Crystal Silver Shade F (001 SSHA)

Crystal F (001)	■	■	■	■	■	■	■
Crystal Aurore Boreale F (001 AB)	■	■	■	■	■	■	■
Crystal Golden Shadow F (001 GSHA)	■	■	■	■	■	■	■
Crystal Silver Night F (001 SINI)	■	■	■	■	■	■	■
Crystal Silver Shade F (001 SSHA)	■	■	■	■	■	■	■

1122 RIVOLI

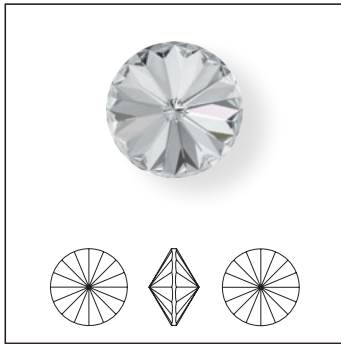

Size	SS 39	SS 47	12 mm	14 mm
------	-------	-------	-------	-------

Crystal	SS 39	SS 47	12 mm	14 mm
Crystal F (001)	■	■	■	■
Colors				
Plain Colors				
Amethyst F (204)	■	■	■	■
Aquamarine F (202)	■	■	■	■
Black Diamond F (215)	■	■	■	■
Citrus Green F (337)	■	■	■	■
Emerald F (205)	■	■	■	■
Iris F (219)	■	■	■	■
Jet (280)	■	■	■	■
Light Amethyst F (212)	■	■	■	■
Light Colorado Topaz F (246)	■	■	■	■
Light Rose F (223)	■	■	■	■
Light Sapphire F (211)	■	■	■	■
Light Siam F (227)	■	■	■	■
Light Topaz F (226)	■	■	■	■
Light Turquoise F (263)	■	■	■	■
Montana F (207)	■	■	■	■
Peridot F (214)	■	■	■	■
Rose F (209)	■	■	■	■
Rose Peach F (262)	■	■	■	■
Sapphire F (206)	■	■	■	■
Scarlet F (276)	■	■	■	■
Siam F (208)	■	■	■	■
Silk F (391)	■	■	■	■
Tanzanite F (539)	■	■	■	■
Vintage Rose F (319)	■	■	■	■

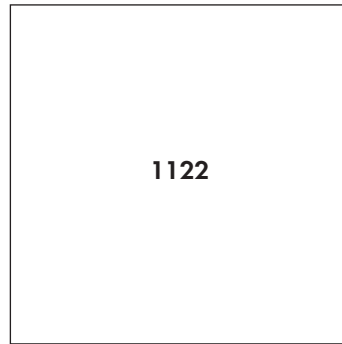

Size	SS 39	SS 47	12 mm	14 mm
------	-------	-------	-------	-------

Crystal Effects	SS 39	SS 47	12 mm	14 mm
Transparent Effects				
Crystal Aurore Boreale F (001 AB)	■	■	■	■
Crystal Golden Shadow F (001 GSHA)	■	■	■	■
Crystal Silver Night F (001 SINI)	■	■	■	■
Crystal Silver Shade F (001 SSHA)	■	■	■	■
Crystal Lacquer <sup>PRO</sup> Effects				
Crystal Dusty Pink DeLite (001 L149D)	■	■	■	■
Crystal Flamingo Ignite (001 L162I)	■	■	■	■
Crystal Ivory Cream DeLite (001 L106D)	■	■	■	■
Crystal Laguna DeLite (001 L142D)	■	■	■	■
Crystal Lavender DeLite (001 L144D)	■	■	■	■
Crystal Linen Ignite (001 L164I)	■	■	■	■
Crystal Lotus Pink DeLite (001 L145D)	■	■	■	■
Crystal Ocean DeLite (001 L143D)	■	■	■	■
Crystal Orange Glow DeLite (001 L146D)	■	■	■	■
Crystal Royal Blue DeLite (001 L110D)	■	■	■	■
Crystal Royal Red DeLite (001 L107D)	■	■	■	■
Crystal Serene Gray DeLite (001 L150D)	■	■	■	■
Crystal Silky Sage DeLite (001 L147D)	■	■	■	■
Crystal Sky Ignite (001 L163I)	■	■	■	■

1383 Fantasy Round Stone

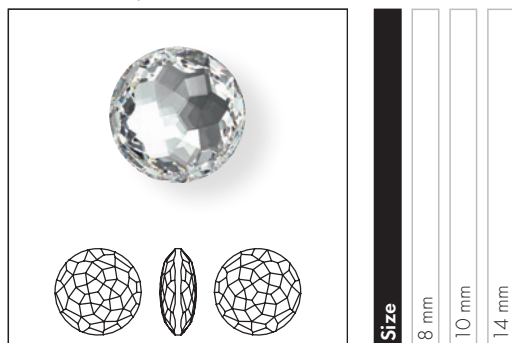

Size  
8 mm  
10 mm  
14 mm

Crystal		
Crystal F (001)	■	■
Colors		
Plain Colors		
Amethyst F (204)	■	■
Aquamarine F (202)	■	■
Emerald F (205)	■	■
Golden Topaz F (1003)	■	■
Jet (280)	■	■
Montana F (207)	■	■
Rose Peach F (262)	■	■
Scarlet F (276)	■	■
Vintage Rose F (319)	■	■
Opal Colors		
White Opal (234)	■	■
Crystal Effects		
Transparent Effects		
Crystal Golden Shadow F (001 GSHA)	■	■
Crystal Ignite (001 IGNIT)	■	■
Crystal Silver Night (001 SINI)	■	■
Crystal Lacquer <sup>PRO</sup> Effects		
Crystal Flamingo Ignite (001 L162I)	■	■
Crystal Linen Ignite (001 L164I)	■	■
Crystal Sky Ignite (001 L163I)	■	■
Color Effects		
Transparent Effects		
Amethyst Ignite (204 IGNIT)	■	■
Aquamarine Ignite (202 IGNIT)	■	■
Emerald Ignite (205 IGNIT)	■	■
Rose Peach Ignite (262 IGNIT)	■	■
Scarlet Ignite (276 IGNIT)	■	■
Vintage Rose Ignite (319 IGNIT)	■	■

1400 Dome Round Stone



Size  
10 mm  
12 mm  
14 mm  
18 mm

Crystal		
Crystal F (001)	■	■
Colors		
Plain Colors		
Aquamarine F (202)	■	■
Emerald F (205)	■	■
Iris F (219)	■	■
Jet (280)	■	■
Light Colorado Topaz F (246)	■	■
Scarlet F (276)	■	■
Opal Colors		
White Opal F (234)	■	■
Crystal Effects		
Transparent Effects		
Crystal Aurore Boreale F (001 AB)	■	■
Crystal Bermuda Blue F (001 BB)	■	■
Crystal Paradise Shine F (001 PARSH)	■	■

**1401** Rose Cut Round Stone



Size	8 mm	10 mm	11.8 mm
------	------	-------	---------

**Crystal**

Crystal F (001)

**Colors**

**Plain Colors**

Vintage Rose F (319)

**Opal Colors**

Rose Water Opal F (395)

White Opal F (234)

**Crystal Effects**

**Transparent Effects**

Crystal Aurore Boreale F (001 AB)

Crystal Golden Shadow F (001 GSMA)

# Product Details

Article Size	Packing Unit = Minimum Order Quantity in Pieces	Average Net Weight in Gram per Packing Unit Crystal (001)	Average Gross Weight in Gram per Packing Unit Crystal (001)
<b>1028</b>			
PP 2	1,440	0.7	11.6
PP 3	1,440	1.1	11.8
PP 4	1,440	1.4	12.2
PP 5	1,440	1.8	12.6
PP 6	1,440	2.1	13.3
PP 7	1,440	2.3	13.6
PP 8	1,440	2.8	14.8
PP 9	1,440	3.4	17.7
PP 10	1,440	3.8	15.2
PP 11	1,440	4.7	16.4
PP 12	1,440	5.6	17.5
PP 13	1,440	6.7	19.2
<b>1088</b>			
PP 14	1,440	7.1	18.1
PP 18	1,440	12.0	23.8
PP 21	1,440	15.8	29.6
PP 24	1,440	24.4	36.8
PP 27	1,440	30.2	46.9
PP 31	1,440	49.2	64.2
PP 32	1,440	53.7	69.9
SS 19	1,440	66.2	91.5
SS 24	720	61.1	79.3
SS 29	288	47.4	71.9
SS 34	144	30.2	62.1
SS 39	144	52.9	74.7
<b>1098</b>			
PP 24	1440	20.96	31.16
PP 31	1440	41.13	51.33
SS 20	720	36.58	46.78
SS 24	720	56.14	66.34
SS 29	288	34.19	51.37
SS 34	144	28.66	45.84
SS 39	144	39.51	56.69
<b>1100</b>			
PP 1	1,440	0.6	9.1
<b>1122</b>			
SS 39	144	37.1	55.2
SS 47	288	158.6	215.9
12 mm	144	99.5	142.2
14 mm	144	167.4	225.9

<b>Article Size</b>	<b>Packing Unit = Minimum Order Quantity in Pieces</b>	<b>Average Net Weight in Gram per Packing Unit Crystal (001)</b>	<b>Average Gross Weight in Gram per Packing Unit Crystal (001)</b>
<b>1383</b>			
8 mm	216	68.6	95.3
10 mm	96	56.6	81.5
14 mm	48	77.7	102
<b>1400</b>			
10 mm	72	42.7	64.6
12 mm	72	75.0	96.9
14 mm	36	59.5	85.9
18 mm	24	84.4	103.3
<b>1401</b>			
8 mm	144	50.1	71.9
10 mm	72	43.6	65.4
11.8 mm	72	75.8	97.8







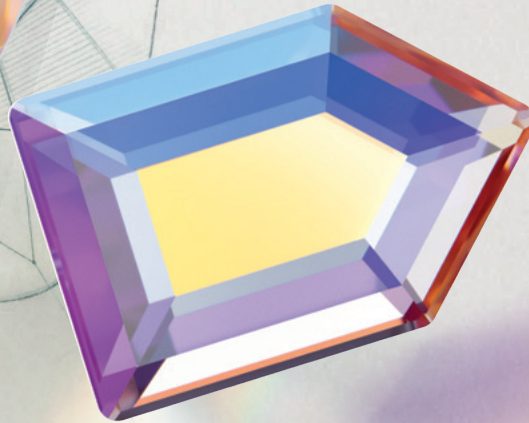

# Flat Backs No Hotfix

Flat Backs No Hotfix are loose crystals backed with platinum foiling for extra brilliance, and protection. Available in a multitude of sizes, colors, shapes and cuts, they are easy to apply to a variety of carrier materials using standard one or two component glues.

The most coveted and famous item in this product group is article 2088 XIRIUS Rose. Incredibly progressive, and completely unique, multi-layer cutting technology is used to create the inspiring XIRIUS star design allowing for superior shine and rich, well-balanced light refraction redefining the market standard.

A reflection of Swarovski's innovation expertise is the 1098 Xirius Light, a groundbreaking hybrid that fuses our most exceptional Swarovski cuts. Combining the height and weight of a Flat Back with additional 8 facets on its backside, it possesses the vigor of a Chaton while maintaining the convenient application of a Flat Back.

Swarovski's outstanding quality is underlined by the highest precision in table size, and diameter.



## Colors & Effects

OPEN TO SEE COLORS & EFFECTS



## Colors







 Crystal 001	 Burgundy 515	 Blue Zircon 229
 White Opal 234	 Amethyst 204	 Erinite 360
 Light Silk 261	 Iris 219	 Chrysolite 238
 Silk 391	 Light Amethyst 212	 Peridot 214
 Light Peach 362	 Provence Lavender 283	 Citrus Green 337
 Vintage Rose 319	 Tanzanite 539	 Fern Green 291
 Blush Rose 257	 Purple Velvet 277	 Emerald 205
 Light Rose 223	 Aquamarine 202	 Jonquil 213
 Rose Peach 262	 Light Sapphire 211	 Light Topaz 226
 Padparadscha 542	 Sapphire 206	 Golden Topaz 1003
 Indian Pink 289	 Capri Blue 243	 Light Colorado Topaz 246
 Rose 209	 Majestic Blue 296	 Topaz 203
 Fuchsia 502	 Cobalt 369	 Light Amber 1002
 Light Siam 227	 Dark Indigo 288	 Smoked Amber 1001
 Scarlet 276	 Montana 207	 Greige 284
 Indian Siam 327	 Denim Blue 266	 Black Diamond 215
 Siam 208	 Indicolite 379	 Graphite 253
 Ruby 501	 Light Turquoise 263	 Jet 280

## Effects







-  Crystal Moonlight  
001 MOL
-  Crystal Shimmer  
001 SHIM
-  Crystal Aurore Boreale  
001 AB
-  Crystal Paradise Shine  
001 PARSH
-  Crystal Volcano  
001 VOL
-  Crystal Blue Shade  
001 BLSH
-  Crystal Golden Shadow  
001 GSHA
-  Crystal Metallic Sunshine  
001 METSH
-  Crystal Rose Gold  
001 ROGL
-  Crystal Light Chrome  
001 LTCH
-  Crystal Silver Shade  
001 SSHA
-  Crystal Silver Night  
001 SINI
-  Jet Hematite  
280 HEM

## Crystal Lacquer<sup>PRO</sup> Effects

### Crystal Lacquer<sup>PRO</sup> Ignite Effects

-  Crystal Linen Ignite  
001 L164I
-  Crystal Flamingo Ignite  
001 L162I
-  Crystal Orange Ignite  
001 L159I
-  Crystal Maroon Ignite  
001 L160I
-  Crystal Purple Ignite  
001 L161I
-  Crystal Sky Ignite  
001 L163I





### Crystal Electric Lacquer<sup>PRO</sup> Effects

-  Crystal Electric White  
001 L139S
-  Crystal Electric Orange  
001 L136S
-  Crystal Electric Pink  
001 L137S
-  Crystal Electric Violet  
001 L148S
-  Crystal Electric Blue  
001 L134S
-  Crystal Electric Green  
001 L135S
-  Crystal Electric Yellow  
001 L138S

## Shimmer Effects

-  Silk Shimmer  
391 SHIM
-  Light Rose Shimmer  
223 SHIM
-  Fuchsia Shimmer  
502 SHIM
-  Light Siam Shimmer  
227 SHIM
-  Tanzanite Shimmer  
539 SHIM
-  Light Sapphire Shimmer  
211 SHIM
-  Blue Zircon Shimmer  
229 SHIM
-  Peridot Shimmer  
214 SHIM
-  Topaz Shimmer  
203 SHIM
-  Black Diamond Shimmer  
215 SHIM

## AB Effects

-  Light Rose Aurore Boreale  
223 AB
-  Light Siam Aurore Boreale  
227 AB
-  Sapphire Aurore Boreale  
206 AB
-  Jonquil Aurore Boreale  
213 AB

## Nightfall Effects

-  Siam Nightfall  
208 NIFA
-  Capri Blue Nightfall  
243 NIFA
-  Emerald Nightfall  
205 NIFA
-  Graphite Nightfall  
253 NIFA

## Numerical Order

001	Crystal	206	Sapphire	262	Rose Peach
001 AB	Crystal Aurore Boreale	207	Montana	263	Light Turquoise
001 BLSH	Crystal Blue Shade	208 NIFA	Siam Nightfall	266	Denim Blue
001 GSHA	Crystal Golden Shadow	208	Siam	276	Scarlet
001 LI34S	Crystal Electric Blue	209	Rose	277	Purple Velvet
001 LI35S	Crystal Electric Green	211 SHIM	Light Sapphire Shimmer	280 HEM	Jet Hematite
001 LI36S	Crystal Electric Orange	211	Light Sapphire	280	Jet
001 LI37S	Crystal Electric Pink	212	Light Amethyst	283	Provence Lavender
001 LI38S	Crystal Electric Yellow	213 AB	Jonquil Aurore Boreale	284	Greige
001 LI39S	Crystal Electric White	213	Jonquil	288	Dark Indigo
001 LI48S	Crystal Electric Violet	214 SHIM	Peridot Shimmer	289	Indian Pink
001 LI59I	Crystal Orange Ignite	214	Peridot	291	Fern Green
001 LI60I	Crystal Maroon Ignite	215 SHIM	Black Diamond Shimmer	296	Majestic Blue
001 LI61I	Crystal Purple Ignite	215	Black Diamond	319	Vintage Rose
001 LI62I	Crystal Flamingo Ignite	219	Iris	327	Indian Siam2
001 LI63I	Crystal Sky Ignite	223 AB	Light Rose Aurore Boreale	337	Citrus Green
001 LI64I	Crystal Linen Ignite	223 SHIM	Light Rose Shimmer	360	Erinite
001 LTCH	Crystal Light Chrome	223	Light Rose	362	Light Peach
001 METSH	Crystal Metallic Sunshine	226	Light Topaz	369	Cobalt
001 MOL	Crystal Moonlight	227 AB	Light Siam Aurore Boreale	379	Indicolite
001 PARSH	Crystal Paradise Shine	227 SHIM	Light Siam Shimmer	391 SHIM	Silk Shimmer
001 ROGL	Crystal Rose Gold	227	Light Siam	391	Silk
001 SHIM	Crystal Shimmer	229 SHIM	Blue Zircon Shimmer	501	Ruby
001 SINI	Crystal Silver Night	229	Blue Zircon	502 SHIM	Fuchsia Shimmer
001 SSHA	Crystal Silver Shade	234	White Opal	502	Fuchsia
001 VOL	Crystal Volcano	238	Chrysolite	515	Burgundy
202	Aquamarine	243 NIFA	Capri Blue Nightfall	539 SHIM	Tanzanite Shimmer
203 SHIM	Topaz Shimmer	243	Capri Blue	539	Tanzanite
203	Topaz	246	Light Colorado Topaz	542	Padparadscha
204	Amethyst	253 NIFA	Graphite Nightfall	1001	Smoked Amber
205 NIFA	Emerald Nightfall	253	Graphite	1002	Light Amber
205	Emerald	257	Blush Rose	1003	Golden Topaz
206 AB	Sapphire Aurore Boreale	261	Light Silk		



## Alphabetical Order

Amethyst (204)	Crystal Rose Gold (001 ROGL)	Light Sapphire (211)
Aquamarine (202)	Crystal Shimmer (001 SHIM)	Light Sapphire Shimmer (211 SHIM)
Black Diamond (215)	Crystal Silver Night (001 SINI)	Light Siam (227)
Black Diamond Shimmer (215 SHIM)	Crystal Silver Shade (001 SSHA)	Light Siam Aurore Boreale (227 AB)
Blue Zircon (229)	Crystal Sky Ignite (001 LI63I)	Light Siam Shimmer (227 SHIM)
Blue Zircon Shimmer (229 SHIM)	Crystal Volcano (001 VOL)	Light Silk (261)
Blush Rose (257)	Dark Indigo (288)	Light Topaz (226)
Burgundy (515)	Denim Blue (266)	Light Turquoise (263)
Capri Blue (243)	Emerald (205)	Majestic Blue (296)
Capri Blue Nightfall (243 NIFA)	Emerald Nightfall (205 NIFA)	Montana (207)
Chrysolite (238)	Erinite (360)	Padparadscha (542)
Citrus Green (337)	Fern Green (291)	Peridot (214)
Cobalt (369)	Fuchsia (502)	Peridot Shimmer (214 SHIM)
Crystal (001)	Fuchsia Shimmer (502 SHIM)	Provence Lavender (283)
Crystal Aurore Boreale (001 AB)	Golden Topaz (1003)	Purple Velvet (277)
Crystal Blue Shade (001 BLSH)	Graphite (253)	Rose (209)
Crystal Electric Blue (001 LI34S)	Graphite Nightfall (253 NIFA)	Rose Peach (262)
Crystal Electric Green (001 LI35S)	Greige (284)	Ruby (501)
Crystal Electric Orange (001 LI36S)	Indian Pink (289)	Sapphire (206)
Crystal Electric Pink (001 LI37S)	Indian Siam2 (327)	Sapphire Aurore Boreale (206 AB)
Crystal Electric Violet (001 LI48S)	Indicolite (379)	Scarlet (276)
Crystal Electric White (001 LI39S)	Iris (219)	Siam (208)
Crystal Electric Yellow (001 LI38S)	Jet Hematite (280 HEM)	Siam Nightfall (208 NIFA)
Crystal Flamingo Ignite (001 LI62I)	Jet (280)	Silk (391)
Crystal Golden Shadow (001 GSHA)	Jonquil (213)	Silk Shimmer (391 SHIM)
Crystal Light Chrome (001 LTCH)	Jonquil Aurore Boreale (213 AB)	Smoked Amber (1001)
Crystal Linen Ignite (001 LI64I)	Light Amber (1002)	Tanzanite (539)
Crystal Maroon Ignite (001 LI60I)	Light Amethyst (212)	Tanzanite Shimmer (539 SHIM)
Crystal Metallic Sunshine (001 METSH)	Light Colorado Topaz (246)	Topaz (203)
Crystal Moonlight (001 MOL)	Light Peach (362)	Topaz Shimmer (203 SHIM)
Crystal Orange Ignite (001 LI59I)	Light Rose (223)	Vintage Rose (319)
Crystal Paradise Shine (001 PARSH)	Light Rose Aurore Boreale (223 AB)	White Opal (234)
Crystal Purple Ignite (001 LI61I)	Light Rose Shimmer (223 SHIM)	

02

For details on available colors and effects for each article within the product groups, please see the product matrix of the respective item in the Collection 2023.

The plating resistance of effects is tested according to Swarovski's plating guidelines (SWAROVSKI.COM/S-PROFESSIONALS). Customers are advised to carry out their own tests if their plating parameters diverge from Swarovski plating guidelines.

Colors and effects can appear different when illuminated with different light sources. Swarovski uses standard light source D65 for color decision and comparison. Slight changes in shades are unavoidable. Colors may vary according to cut and foiling.

The composition of Advanced Crystal is compliant with regulatory industry norms and laws regarding the restriction or prohibition of certain substances in the most relevant segments of our customers. Please note that the compliance of the colors Light Siam and Siam varies according to certain industry regulations. Those regulations are indicated with \* in the compliance overview. Indian Siam, Ruby and Scarlet (option to Lt. Siam) conform to all CLEAR-lists. For further information please visit [swarovski.com/s-professionals](http://swarovski.com/s-professionals)

© 2023 D. Swarovski Distribution GmbH

# Summary

1 2 3		<b>1098</b> PP 24 (SS 12), PP 31 (SS 16) SS 20, 24, 29, 34, 39	1 2		<b>2304</b> 6x1.7, 10x2.8, 14x3.9 mm	1 2		<b>2711</b> 3.3 mm
		<b>2000</b> SS 3, 4			<b>2400</b> 2.2, 3, 4, 6 mm			<b>2715</b> 3, 4 mm
		<b>2019</b> 4x4, 5x5, 6x6 mm			<b>2471</b> 5, 7, 10 mm			<b>2716</b> 5 mm
		<b>2035</b> 6, 10, 14, 20, 30, 40 mm			<b>2472</b> 5, 7, 10 mm			<b>2738</b> 10x5, 12x6 mm
		<b>2058</b> SS 5, 6, 7, 8, 9, 10			<b>2483</b> 10, 25 mm			<b>2739</b> 5.8x5.3, 7x6.5 mm
		<b>2072</b> 8, 10, 12 mm			<b>2493</b> 8, 10, 20 mm			<b>2740</b> 8.3x8.3, 10x10 mm
		<b>2088</b> SS 12, 14, 16, 20, 24, 30, 34, 40, 48			<b>2510</b> 3.7x1.9 mm			<b>2754</b> 4, 6 mm
		<b>2200</b> 4x2, 8x4 mm			<b>2520</b> 8x6, 10x8, 14x10 mm			<b>2770</b> 6x3.5, 12x7 mm
		<b>2201</b> 4x1.8, 8x3.5, 14x6 mm			<b>2555</b> 8x2.6, 12x4			<b>2771</b> 6.4x4.2, 8.6x5.6, 12.9x8.3 mm
		<b>2205</b> 7.5, 10, 14 mm			<b>2602</b> 3.7x2.5, 8x5.5, 14x10 mm			<b>2772</b> 6.5x2.1, 8.6x2.8, 12.9x4.2 mm
		<b>2300</b> 8x4.8, 10x6 mm			<b>2603</b> 4x3, 8x6, 14x10 mm			<b>2773</b> 5x3, 6.6x3.9, 9.9x5.9 mm
		<b>2303</b> 8x5, 14x9 mm			<b>2709</b> 10x6, 13x8 mm			<b>2774</b> 6.3x4.2, 8.3x5.6, 12.5x8.4 mm

1 Top view 2 Side view 3 Back view

1 2



**2775**  
5x4.2, 6.7x5.6,  
10x8.4 mm



**2776**  
8.2x4.2, 11x5.6,  
16.5x8.4 mm



**2777**  
5x4.2, 6.7x5.6,  
10x8.4 mm



**2808**  
3.6, 6, 10, 14 mm



**2813**  
8x5.5 mm



**2816**  
5 mm



**2854**  
8, 12 mm



**2856**  
10x7.5, 14x10.5, 18x14 mm

02

**1098 XIRIUS Light**

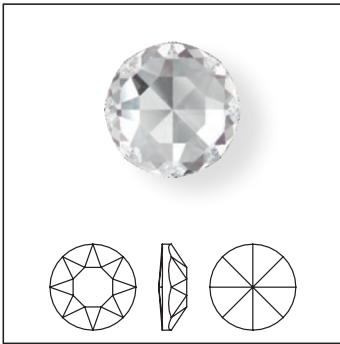

Size	PP 24   SS 12	PP 31   SS 16	SS 20	SS 24	SS 29	SS 34	SS 39
------	---------------	---------------	-------	-------	-------	-------	-------

**Crystal**

Crystal F (001)

**Crystal Effects**

**Transparent Effects**

Crystal Aurore Boreale F (001 AB)

Crystal Golden Shadow F (001 GSHA)

Crystal Silver Night F (001 SINI)

Crystal Silver Shade F (001 SSHA)

Crystal F (001)	■	■	■	■	■	■	■
Crystal Aurore Boreale F (001 AB)	■	■	■	■	■	■	■
Crystal Golden Shadow F (001 GSHA)	■	■	■	■	■	■	■
Crystal Silver Night F (001 SINI)	■	■	■	■	■	■	■
Crystal Silver Shade F (001 SSHA)	■	■	■	■	■	■	■

**2000 Rose**

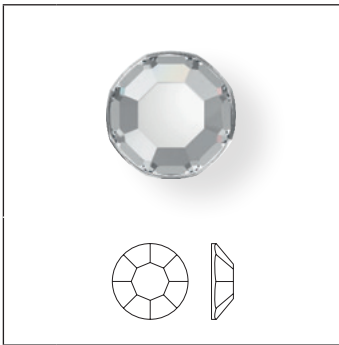

**Size** SS 3, 4

**2058 XILION Rose**

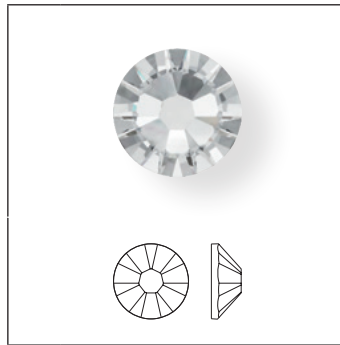

**Size** SS 5, 6, 7, 8, 9, 10

**2088 XIRIUS Rose**

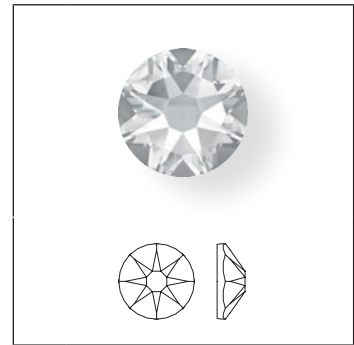

**Size** SS 12, 14, 16, 20, 24, 30, 34, 40, 48

	2000 Rose		2058 XILION Rose							2088 XIRIUS Rose							
	SS 3	SS 4	SS 5	SS 6	SS 7	SS 8	SS 9	SS 10	SS 12	SS 14	SS 16	SS 20	SS 24	SS 30	SS 34	SS 40	SS 48
<b>Crystal</b>																	
Crystal F (001)	■	■	■	■	■	■	■	■	■	■	■	■	■	■	■	■	■
<b>Colors</b>																	
<b>Plain Colors</b>																	
Amethyst F (204)			■	■	■	■	■	■	■	■	■	■	■	■	■	■	■
Aquamarine F (202)	■		■	■	■	■	■	■	■	■	■	■	■	■	■	■	■
Black Diamond F (215)	■		■	■	■	■	■	■	■	■	■	■	■	■	■	■	■
Blue Zircon F (229)			■	■	■	■	■	■	■	■	■	■	■	■	■	■	■
Blush Rose F (257)			■	■	■	■	■	■	■	■	■	■	■	■	■	■	■
Burgundy F (515)			■	■	■	■	■	■	■	■	■	■	■	■	■	■	■
Capri Blue F (243)			■	■	■	■	■	■	■	■	■	■	■	■	■	■	■
Chrysolite F (238)			■	■	■	■	■	■	■	■	■	■	■	■	■	■	■
Citrus Green F (337)			■	■	■	■	■	■	■	■	■	■	■	■	■	■	■
Cobalt F (369)			■	■	■	■	■	■	■	■	■	■	■	■	■	■	■
Dark Indigo F (288)			■	■	■	■	■	■	■	■	■	■	■	■	■	■	■
Denim Blue F (266)			■	■	■	■	■	■	■	■	■	■	■	■	■	■	■
Emerald F (205)			■	■	■	■	■	■	■	■	■	■	■	■	■	■	■
Erinite F (360)			■	■	■	■	■	■	■	■	■	■	■	■	■	■	■

\* All colors with a 4-digit color code (i.e. Golden Topaz) are fully customizable with shorter lead times and lower MOQs compared to our 3-digit colors. Please get in touch with the Customer Service for a time and quantity estimation of your desired variant.

	2000		2058		2088																	
	Size	2000 Rose	SS 3	SS 4	2058 XILLION Rose	SS 5	SS 6	SS 7	SS 8	SS 9	SS 10	2088 XIRIUS Rose	SS 12	SS 14	SS 16	SS 20	SS 24	SS 30	SS 34	SS 40	SS 48	
Fern Green F (291)																						
Fuchsia F (502)																						
Golden Topaz F (1003)*																						
Graphite F (253)																						
Greige F (284)																						
Indian Pink F (289)																						
Indian Siam F (327)																						
Indicolite F (379)																						
Iris F (219)																						
Jet (280)																						
Jet F (280)																						
Jonquil F (213)																						
Light Amber F (1002)*																						
Light Amethyst F (212)																						
Light Colorado Topaz F (246)																						
Light Peach F (362)																						
Light Rose F (223)																						
Light Sapphire F (211)																						
Light Siam F (227)																						
Light Silk F (261)																						
Light Topaz F (226)																						
Light Turquoise F (263)																						
Majestic Blue F (296)																						
Montana F (207)																						
Padparadscha F (542)																						
Peridot F (214)																						
Provence Lavender F (283)																						
Purple Velvet F (277)																						
Rose F (209)																						
Rose Peach F (262)																						
Ruby F (501)																						
Sapphire F (206)																						

\* All colors with a 4-digit color code (i.e. Golden Topaz) are fully customizable with shorter lead times and lower MOQs compared to our 3-digit colors. Please get in touch with the Customer Service for a time and quantity estimation of your desired variant.

	2000		2058		2088																
	Size	2000 Rose	SS 3	SS 4	2058 XILLION Rose	SS 5	SS 6	SS 7	SS 8	SS 9	SS 10	2088 XIRIUS Rose	SS 12	SS 14	SS 16	SS 20	SS 24	SS 30	SS 34	SS 40	SS 48
Scarlet F (276)						■		■	■	■			■		■	■		■	■		
Siam F (208)						■		■	■	■			■		■	■		■	■		
Silk F (391)						■		■	■	■			■		■	■		■	■		
Smoked Amber F (1001)*		■				■		■	■	■			■		■	■		■	■		
Tanzanite F (539)						■		■	■	■			■		■	■		■	■		
Topaz F (203)						■		■	■	■			■		■	■		■	■		
Vintage Rose F (319)						■		■	■	■			■		■	■		■	■		
<b>Opal Colors</b>																					
White Opal F (234)						■		■	■	■			■		■	■		■	■		
<b>Crystal Effects</b>																					
<b>Transparent Effects</b>																					
Crystal Aurore Boreale F (001 AB)		■	■			■	■	■	■	■	■		■	■	■	■	■	■	■	■	■
Crystal Blue Shade F (001 BLSH)						■		■	■	■			■		■	■		■	■		
Crystal Golden Shadow F (001 GSHA)		■				■		■	■	■			■		■	■		■	■		
Crystal Moonlight F (001 MOL)						■		■	■	■			■		■	■		■	■		
Crystal Paradise Shine F (001 PARSH)						■		■	■	■			■		■	■		■	■		
Crystal Shimmer F (001 SHIM)						■		■	■	■			■		■	■		■	■		
Crystal Silver Night F (001 SINI)		■				■		■	■	■			■		■	■		■	■		
Crystal Silver Shade F (001 SSHA)		■				■		■	■	■			■		■	■		■	■		
Crystal Volcano F (001 VOL)						■		■	■	■			■		■	■		■	■		
<b>Metallic Effects</b>																					
Crystal Light Chrome F (001 LTCH)						■		■	■	■			■		■	■		■	■		
Crystal Metallic Sunshine F (001 METSH)						■		■	■	■			■		■	■		■	■		
Crystal Rose Gold F (001 ROGL)		■				■		■	■	■			■		■	■		■	■		
<b>Crystal Lacquer<sup>PRO</sup> Effects</b>																					
<b>Crystal Lacquer<sup>PRO</sup> Ignite Effects</b>																					
Crystal Flamingo Ignite (001 L162I)													■		■	■		■			
Crystal Linen Ignite (001 L164I)													■		■	■		■			
Crystal Maroon Ignite (001 L160I)													■		■	■		■			
Crystal Orange Ignite (001 L159I)													■		■	■		■			
Crystal Purple Ignite (001 L161I)													■		■	■		■			
Crystal Sky Ignite (001 L163I)													■		■	■		■			

2000 2058 2088		Size	2000 Rose	SS 3	SS 4	2058 XILLION Rose	SS 5	SS 6	SS 7	SS 8	SS 9	SS 10	2088 XIRIUS Rose	SS 12	SS 14	SS 16	SS 20	SS 24	SS 30	SS 34	SS 40	SS 48	
<b>Crystal Electric Lacquer<sup>PRO</sup> Effects</b>																							
	Crystal Electric Blue (001 L134S)													■		■	■		■				
	Crystal Electric Green (001 L135S)													■		■	■		■				
	Crystal Electric Orange (001 L136S)													■		■	■		■				
	Crystal Electric Pink (001 L137S)													■		■	■		■				
	Crystal Electric Violet (001 L148S)													■		■	■		■				
	Crystal Electric White (001 L139S)													■		■	■		■				
	Crystal Electric Yellow (001 L138S)													■		■	■		■				
<b>Color Effects</b>																							
<b>Transparent Effects</b>																							
	Black Diamond Shimmer F (215 SHIM)						■				■			■		■	■		■				
	Blue Zircon Shimmer F (229 SHIM)						■				■			■		■	■		■				
	Capri Blue Nightfall F (243 NIFA)						■				■			■		■	■		■		■		
	Emerald Nightfall F (205 NIFA)						■				■			■		■	■		■		■		
	Fuchsia Shimmer F (502 SHIM)						■				■			■		■	■		■				
	Graphite Nightfall F (253 NIFA)						■				■			■		■	■		■		■		
	Jonquil AB F (213 AB)						■				■			■		■	■		■				
	Light Rose AB F (223 AB)						■				■			■		■	■		■				
	Light Rose Shimmer F (223 SHIM)						■				■			■		■	■		■				
	Light Sapphire Shimmer F (211 SHIM)						■				■			■		■	■		■				
	Light Siam AB F (227 AB)						■				■			■		■	■		■				
	Light Siam Shimmer F (227 SHIM)						■				■			■		■	■		■				
	Peridot Shimmer F (214 SHIM)						■				■			■		■	■		■				
	Sapphire AB F (206 AB)						■				■			■		■	■		■				
	Siam Nightfall F (208 NIFA)						■				■			■		■	■		■		■		
	Silk Shimmer F (391 SHIM)						■				■			■		■	■		■				
	Tanzanite Shimmer F (539 SHIM)						■				■			■		■	■		■				
	Topaz Shimmer F (203 SHIM)						■				■			■		■	■		■				
<b>Metallic Effects</b>																							
	Jet Hematite F (280 HEM)			■			■		■		■			■		■	■		■		■		



2019 Round Spike Flat Back

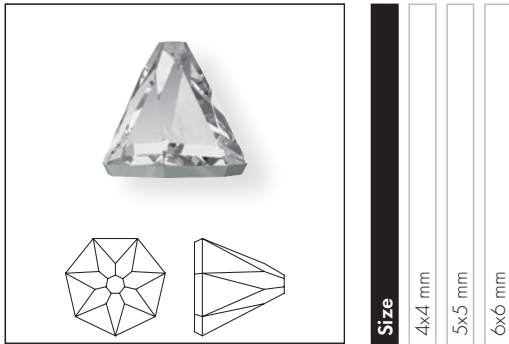

	4x4 mm	5x5 mm	6x6 mm
<b>Crystal</b>			
Crystal F (001)	■	■	■
<b>Crystal Effects</b>			
<b>Transparent Effects</b>			
Crystal Aurore Boreale F (001 AB)	■	■	■
Crystal Blue Shade F (001 BLSH)	■	■	■
Crystal Golden Shadow F (001 GSHA)	■	■	■
Crystal Volcano F (001 VOL)	■	■	■
<b>Color Effects</b>			
<b>Transparent Effects</b>			
Black Diamond Shimmer F (215 SHIM)	■	■	■
Light Topaz Shimmer F (226 SHIM)	■	■	■

2035 Chessboard Circle Flat Back

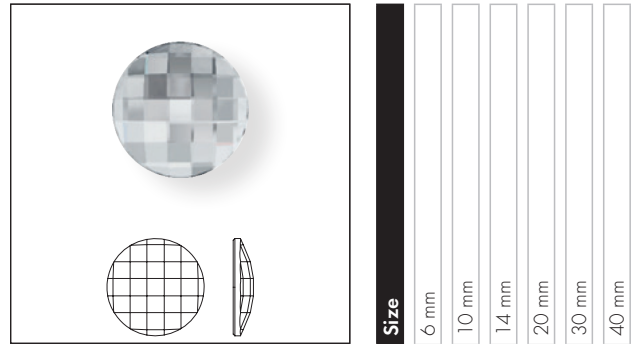

	6 mm	10 mm	14 mm	20 mm	30 mm	40 mm
<b>Crystal</b>						
Crystal F (001)	■	■	■	■	■	■
<b>Crystal Effects</b>						
<b>Metallic Effects</b>						
Crystal Comet Argent Light V SI (001 CAVSI)				■	■	■

02

2072 Rose Cut Flat Back

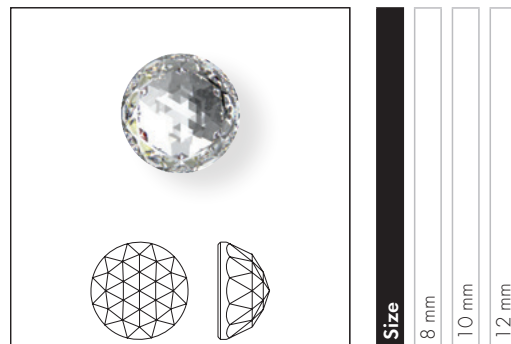

	8 mm	10 mm	12 mm
<b>Crystal</b>			
Crystal F (001)	■	■	■

**2200 Navette Flat Back**

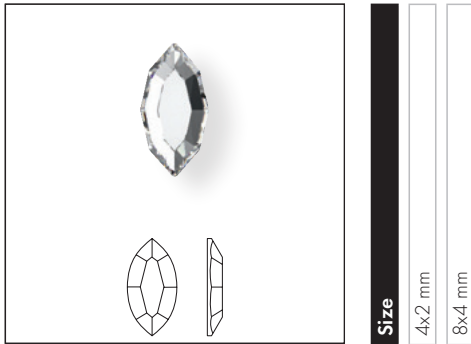

**Size**  
4x2 mm  
8x4 mm

**Crystal**

Crystal F (001)

**Colors**

**Plain Colors**

Scarlet F (276)

**Crystal Effects**

**Transparent Effects**

Crystal Aurore Boreale F (001 AB)

Crystal Golden Shadow F (001 GSHA)

**2201 Marquise Flat Back**

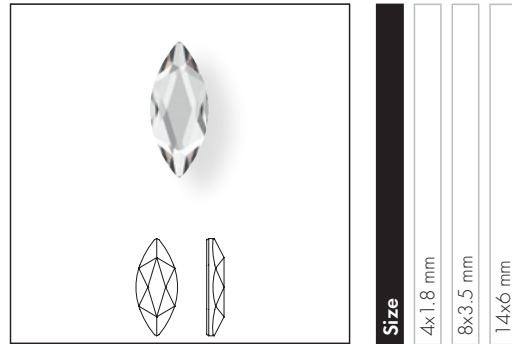

**Size**  
4x1.8 mm  
8x3.5 mm  
14x6 mm

**Crystal**

Crystal F (001)

**Colors**

**Plain Colors**

Aquamarine F (202)

Emerald F (205)

Graphite F (253)

Jet (280)

Sapphire F (206)

Scarlet F (276)

Vintage Rose F (319)

**Crystal Effects**

**Transparent Effects**

Crystal Aurore Boreale F (001 AB)

Crystal Golden Shadow F (001 GSHA)

**Color Effects**

**Transparent Effects**

Vintage Rose Shimmer F (319 SHIM)

**2300 Drop Flat Back**



**Size**  
8x4.8 mm  
10x6 mm

**Crystal**

Crystal F (001)

**2205** Flame Flat Back

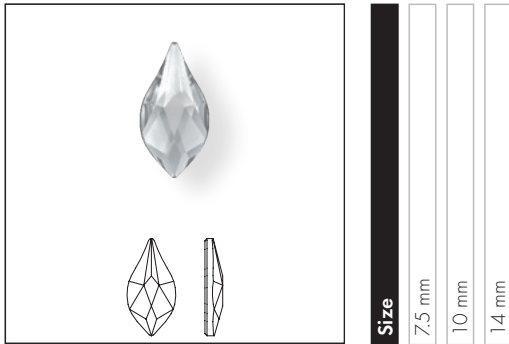

Crystal	7.5 mm	10 mm	14 mm
Crystal F (001)			
Colors			
Plain Colors			
Light Siam F (227)			
Opal Colors			
White Opal F (234)			
Crystal Effects			
Transparent Effects			
Crystal Aurore Boreale F (001 AB)			
Crystal Golden Shadow F (001 GSHA)			

**2303** Pear Flat Back

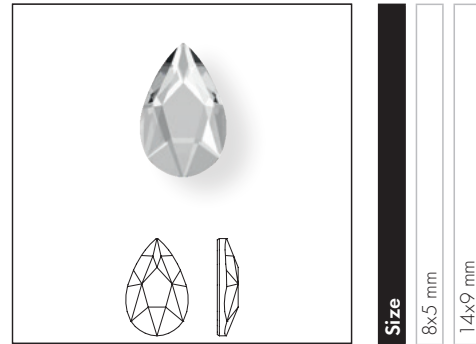

Crystal	8x5 mm	14x9 mm
Crystal F (001)		
Colors		
Plain Colors		
Aquamarine F (202)		
Emerald F (205)		
Graphite F (253)		
Jet (280)		
Sapphire F (206)		
Scarlet F (276)		
Vintage Rose F (319)		
Crystal Effects		
Transparent Effects		
Crystal Aurore Boreale F (001 AB)		
Crystal Golden Shadow F (001 GSHA)		
Color Effects		
Transparent Effects		
Vintage Rose Shimmer F (319 SHIM)		

### 2304 Raindrop Flat Back

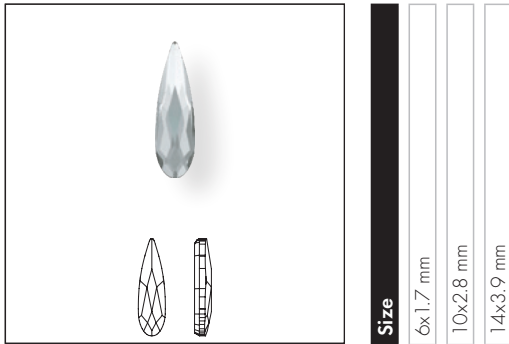

**Size**

6x1.7 mm  
10x2.8 mm  
14x3.9 mm

Crystal	6x1.7 mm	10x2.8 mm	14x3.9 mm
Crystal F (001)	■	■	■
<b>Colors</b>			
<b>Plain Colors</b>			
Light Siam F (227)	■	■	■
<b>Crystal Effects</b>			
<b>Transparent Effects</b>			
Crystal Aurore Boreale F (001 AB)	■	■	■
Crystal Golden Shadow F (001 GSHA)	■	■	■

### 2400 Square Flat Back

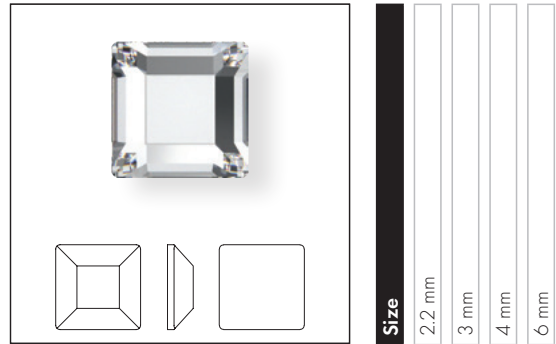

**Size**

2.2 mm  
3 mm  
4 mm  
6 mm

Crystal	2.2 mm	3 mm	4 mm	6 mm
Crystal F (001)	■	■	■	■
<b>Colors</b>				
<b>Plain Colors</b>				
Amethyst F (204)		■	■	
Aquamarine F (202)		■	■	
Black Diamond F (215)		■	■	
Emerald F (205)		■	■	
Jet (280)		■	■	■
Light Colorado Topaz F (246)		■	■	■
Light Rose F (223)		■	■	
Scarlet F (276)		■	■	
<b>Crystal Effects</b>				
<b>Transparent Effects</b>				
Crystal Aurore Boreale F (001 AB)	■	■	■	■
Crystal Golden Shadow F (001 GSHA)		■	■	■
Crystal Silver Night (001 SINI)		■	■	

2471 Cushion Flat Back

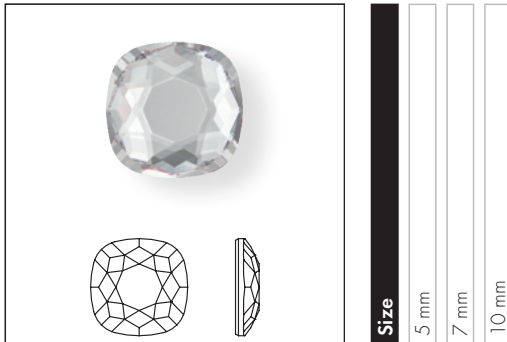

Crystal	5 mm	7 mm	10 mm
Crystal F (001)	■	■	■
<b>Colors</b>			
<b>Plain Colors</b>			
Aquamarine F (202)	■	■	■
Emerald F (205)	■	■	■
Graphite F (253)	■	■	■
Jet (280)	■	■	■
Sapphire F (206)	■	■	■
Scarlet F (276)	■	■	■
Vintage Rose F (319)	■	■	■
<b>Crystal Effects</b>			
<b>Transparent Effects</b>			
Crystal Aurore Boreale F (001 AB)	■	■	■
Crystal Golden Shadow F (001 GSHA)	■	■	■
<b>Color Effects</b>			
<b>Transparent Effects</b>			
Vintage Rose Shimmer F (319 SHIM)	■	■	■

2472

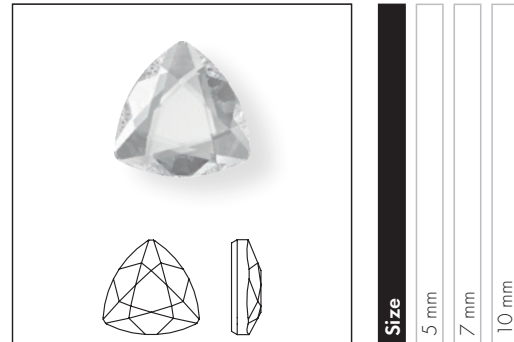

Crystal	5 mm	7 mm	10 mm
Crystal F (001)	■	■	■
<b>Colors</b>			
<b>Plain Colors</b>			
Aquamarine F (202)	■	■	■
Emerald F (205)	■	■	■
Graphite F (253)	■	■	■
Jet (280)	■	■	■
Sapphire F (206)	■	■	■
Scarlet F (276)	■	■	■
Vintage Rose F (319)	■	■	■
<b>Crystal Effects</b>			
<b>Transparent Effects</b>			
Crystal Aurore Boreale F (001 AB)	■	■	■
Crystal Golden Shadow F (001 GSHA)	■	■	■

**2483** Classic Square Flat Back

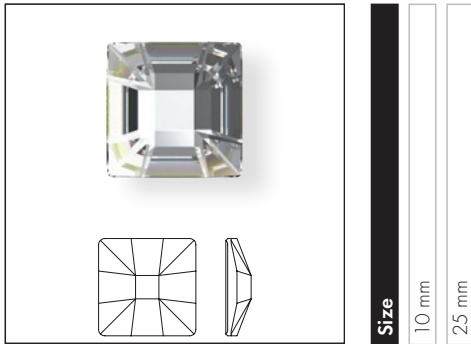

**Size**  
10 mm  
25 mm

**Crystal**

Crystal F (001)

**Crystal Effects**

**Metallic Effects**

Crystal Comet Argent Light SI (001 CASI)

Crystal Comet Argent Light V SI (001 CAVSI)

**2493** Chessboard Flat Back

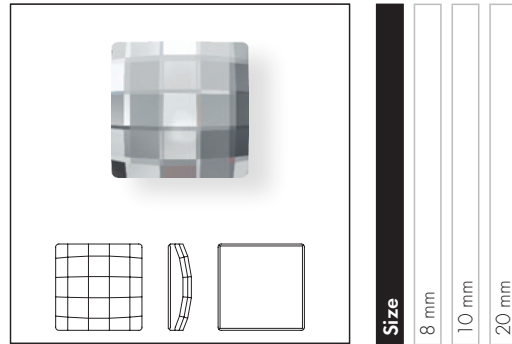

**Size**  
8 mm  
10 mm  
20 mm

**Crystal**

Crystal F (001)

**Crystal Effects**

**Transparent Effects**

Crystal Aurore Boreale F (001 AB)

**2510** Baguette Flat Back

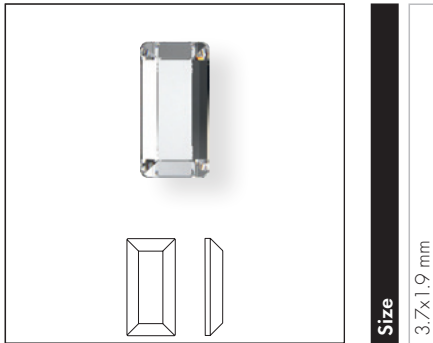

**Size**  
3,7x1,9 mm

**Crystal**

Crystal F (001)

**Colors**

**Plain Colors**

Jet (280)

**Crystal Effects**

**Transparent Effects**

Crystal Aurore Boreale F (001 AB)

Crystal Golden Shadow F (001 GSHA)

**2520** Cosmic Flat Back

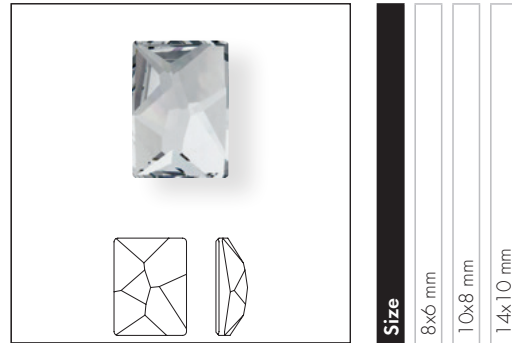

**Size**  
8x6 mm  
10x8 mm  
14x10 mm

**Crystal**

Crystal F (001)

**Colors**

**Plain Colors**

Jet (280)

**Crystal Effects**

**Transparent Effects**

Crystal Aurore Boreale F (001 AB)

Crystal Golden Shadow F (001 GSHA)

**2555 Cosmic Baguette Flat Back**

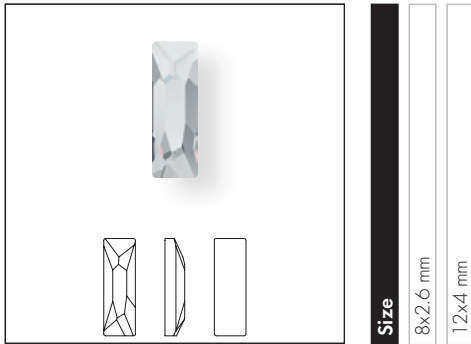

**Size**

8x2.6 mm

12x4 mm

**Crystal**

Crystal F (001)

**Crystal Effects**

**Transparent Effects**

Crystal Aurore Boreale F (001 AB)

Crystal Golden Shadow F (001 GSHA)

**2602 Emerald Cut Flat Back**

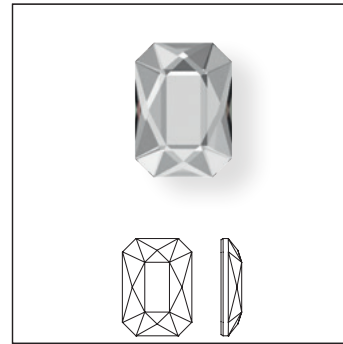

**Size**

3.7x2.5 mm

8x5.5 mm

14x10 mm

**Crystal**

Crystal F (001)

**Colors**

**Plain Colors**

Aquamarine F (202)

Emerald F (205)

Graphite F (253)

Jet (280)

Sapphire F (206)

Scarlet F (276)

Vintage Rose F (319)

**Crystal Effects**

**Transparent Effects**

Crystal Aurore Boreale F (001 AB)

Crystal Golden Shadow F (001 GSHA)

**Color Effects**

**Transparent Effects**

Vintage Rose Shimmer F (319 SHIM)

### 2603 Oval Flat Back

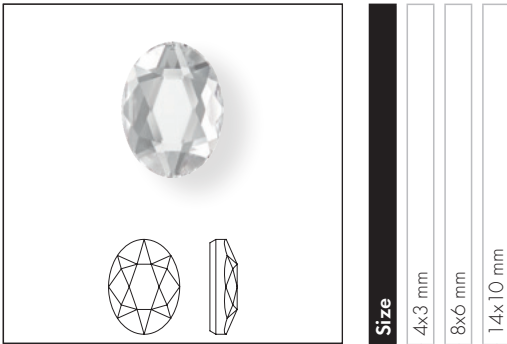

Crystal	4x3 mm	8x6 mm	14x10 mm
Crystal F (001)	■	■	■
Colors			
Plain Colors			
Aquamarine F (202)	■	■	■
Emerald F (205)	■	■	■
Graphite F (253)	■	■	■
Jet (280)	■	■	■
Sapphire F (206)	■	■	■
Scarlet F (276)	■	■	■
Vintage Rose F (319)	■	■	■
Crystal Effects			
Transparent Effects			
Crystal Aurore Boreale F (001 AB)	■	■	■
Crystal Golden Shadow F (001 GSXA)	■	■	■

### 2709 Rhombus Flat Back

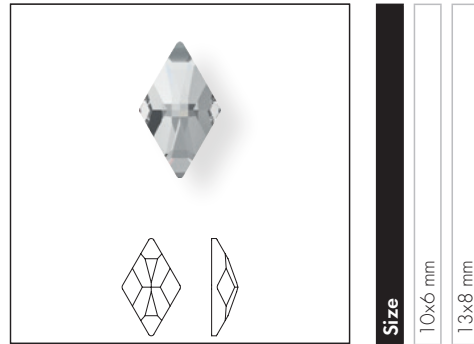

Crystal	10x6 mm	13x8 mm
Crystal F (001)	■	■
Colors		
Plain Colors		
Aquamarine F (202)	■	■
Black Diamond F (215)	■	■
Light Rose F (223)	■	■
Light Siam F (227)	■	■
Crystal Effects		
Transparent Effects		
Crystal Aurore Boreale F (001 AB)	■	■
Crystal Golden Shadow F (001 GSXA)	■	■
Crystal Silver Shade F (001 SSHA)	■	■



**2711 Triangle Flat Back**

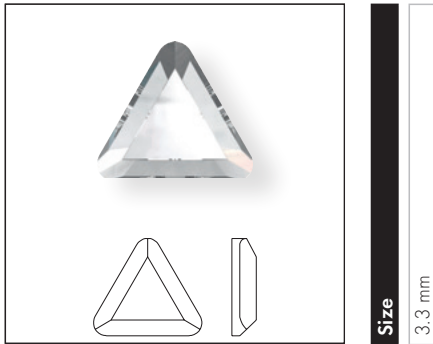

**Size**  
3.3 mm

**Crystal**

Crystal F (001)

**Crystal Effects**

**Transparent Effects**

Crystal Aurore Boreale F (001 AB)

Crystal Golden Shadow F (001 GSHA)

**2715 Connector Flat Back**

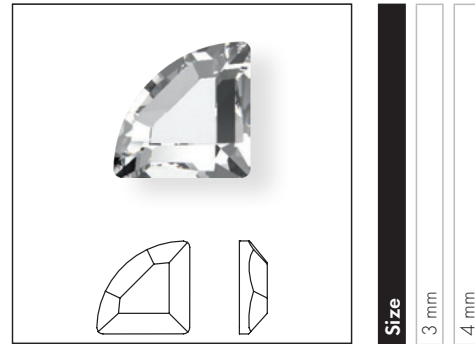

**Size**  
3 mm  
4 mm

**Crystal**

Crystal F (001)

**Colors**

**Plain Colors**

Amethyst F (204)

Aquamarine F (202)

Emerald F (205)

Jet (280)

Light Colorado Topaz F (246)

Scarlet F (276)

**Crystal Effects**

**Transparent Effects**

Crystal Aurore Boreale F (001 AB)

Crystal Golden Shadow F (001 GSHA)

Crystal Silver Night F (001 SINI)

**2716 Rivoli Triangle Flat Back**

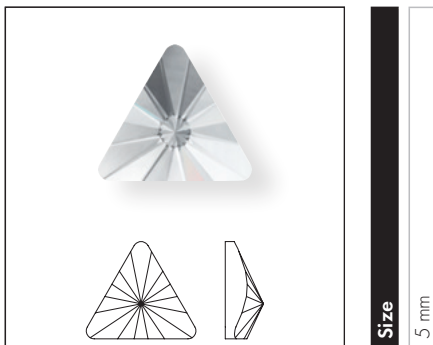

**Size**  
5 mm

**Crystal**

Crystal F (001)

**Crystal Effects**

**Transparent Effects**

Crystal Aurore Boreale F (001 AB)

**TRIANGLE FAMILY**

**2739** Triangle Beta Flat Back



**Size**

5.8x5.3 mm

7x6.5 mm

**Crystal**

Crystal F (001)

**Crystal Effects**

**Transparent Effects**

Crystal Aurore Boreale F (001 AB)

Crystal Golden Shadow F (001 GSHA)

Crystal Silver Night (001 SINI)

**2740** Triangle Gamma Flat Back

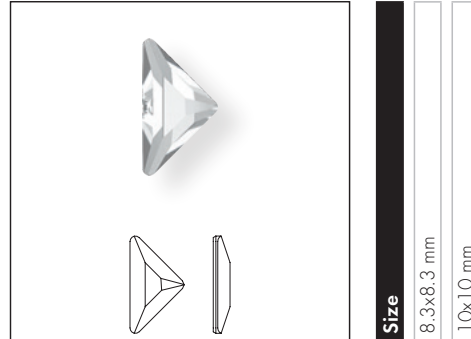

**Size**

8.3x8.3 mm

10x10 mm

**Crystal**

Crystal F (001)

**Crystal Effects**

**Transparent Effects**

Crystal Aurore Boreale F (001 AB)

Crystal Golden Shadow F (001 GSHA)

Crystal Silver Night (001 SINI)

**2754** Star Flower Flat Back NoHF

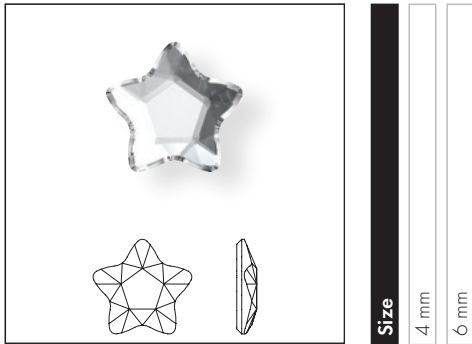

- Crystal**
- Crystal F (001)
- Colors**
- Plain Colors**
- Amethyst F (204)
- Aquamarine F (202)
- Iris F (219)
- Jet (280)
- Light Rose F (223)
- Light Topaz F (226)
- Peridot F (214)
- Rose F (209)
- Scarlet F (276)
- Crystal Effects**
- Transparent Effects**
- Crystal Aurore Boreale F (001 AB)
- Crystal Golden Shadow F (001 GSHA)

**2770** Wing Flat Back

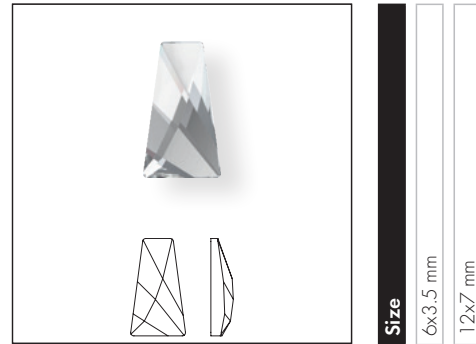

- Crystal**
- Crystal F (001)
- Colors**
- Plain Colors**
- Black Diamond F (215)
- Crystal Effects**
- Transparent Effects**
- Crystal Golden Shadow F (001 GSHA)

02

**GEOMETRIC FLAT BACKS**

**2771 Kite Flat Back**

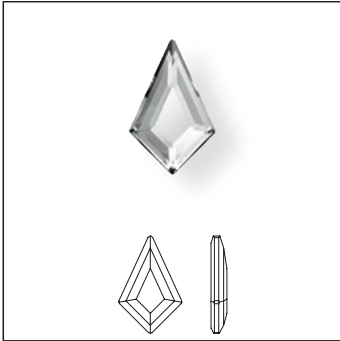

Size
6.4x4.2 mm
8.6x5.6 mm
12.9x8.3 mm

Crystal	Crystal F (001)		
Colors			
Plain Colors			
Aquamarine F (202)			
Black Diamond F (215)			
Jet (280)			
Light Rose F (223)			
Light Siam F (227)			
Crystal Effects			
Transparent Effects			
Crystal Aurore Boreale F (001 AB)			
Crystal Golden Shadow F (001 GSHA)			
Crystal Silver Shade F (001 SSHA)			
Color Effects			
Metallic Effects			
Jet Hematite (280 HEM)			

**2772 Trapeze Flat Back**

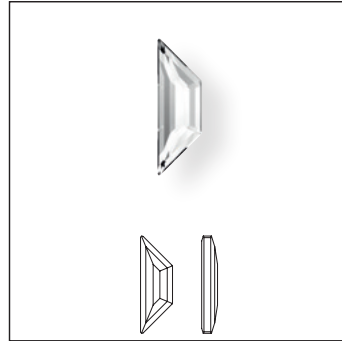

Size
6.5x2.1 mm
8.6x2.8 mm
12.9x4.2 mm

Crystal	Crystal F (001)		
Colors			
Plain Colors			
Aquamarine F (202)			
Black Diamond F (215)			
Jet (280)			
Crystal Effects			
Transparent Effects			
Crystal Aurore Boreale F (001 AB)			
Crystal Golden Shadow F (001 GSHA)			
Crystal Silver Shade F (001 SSHA)			
Color Effects			
Metallic Effects			
Jet Hematite (280 HEM)			

Geometric Flat Backs

**2773** Diamond Shape Flat Back

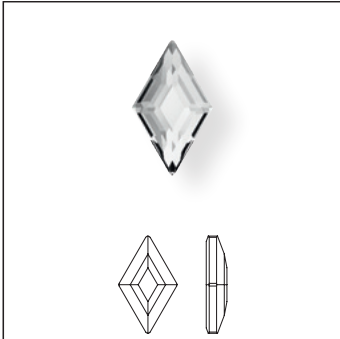

<b>Size</b>	5x3 mm	6.6x3.9 mm	9.9x5.9 mm
-------------	--------	------------	------------

<b>Crystal</b>	Crystal F (001)		
<b>Colors</b>			
<b>Plain Colors</b>			
Aquamarine F (202)			
Black Diamond F (215)			
Jet (280)			
Light Rose F (223)			
Light Siam F (227)			
<b>Crystal Effects</b>			
<b>Transparent Effects</b>			
Crystal Aurore Boreale F (001 AB)			
Crystal Golden Shadow F (001 GSXA)			
Crystal Silver Shade F (001 SSXA)			
<b>Color Effects</b>			
<b>Metallic Effects</b>			
Jet Hematite (280 HEM)			

**2774** Elongated Pentagon Flat Back

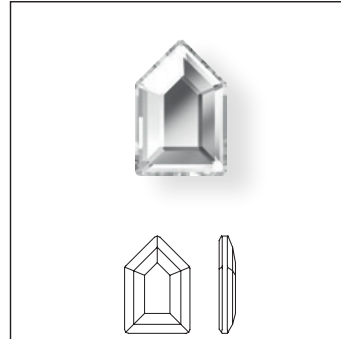

<b>Size</b>	6.3x4.2 mm	8.3x5.6 mm	12.5x8.4 mm
-------------	------------	------------	-------------

<b>Crystal</b>	Crystal F (001)		
<b>Colors</b>			
<b>Plain Colors</b>			
Aquamarine F (202)			
Black Diamond F (215)			
Jet (280)			
Light Siam F (227)			
<b>Crystal Effects</b>			
<b>Transparent Effects</b>			
Crystal Aurore Boreale F (001 AB)			
Crystal Silver Shade F (001 SSXA)			
<b>Color Effects</b>			
<b>Metallic Effects</b>			
Jet Hematite (280 HEM)			

**2775** Concise Pentagon Flat Back



<b>Size</b>	5x4.2 mm	6.7x5.6 mm	10x8.4 mm
-------------	----------	------------	-----------

<b>Crystal</b>	Crystal F (001)		
<b>Colors</b>			
<b>Plain Colors</b>			
Aquamarine F (202)			
Black Diamond F (215)			
Jet (280)			
Light Siam F (227)			
<b>Crystal Effects</b>			
<b>Transparent Effects</b>			
Crystal Aurore Boreale F (001 AB)			
Crystal Silver Shade F (001 SSHA)			
<b>Color Effects</b>			
<b>Metallic Effects</b>			
Jet Hematite (280 HEM)			

**2776** Elongated Hexagon Flat Back

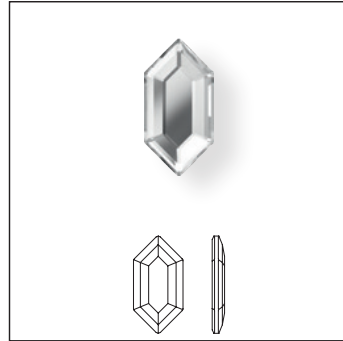

<b>Size</b>	8.2x4.2 mm	11x5.6 mm	16.5x8.4 mm
-------------	------------	-----------	-------------

<b>Crystal</b>	Crystal F (001)		
<b>Colors</b>			
<b>Plain Colors</b>			
Aquamarine F (202)			
Black Diamond F (215)			
Jet (280)			
Light Siam F (227)			
<b>Crystal Effects</b>			
<b>Transparent Effects</b>			
Crystal Aurore Boreale F (001 AB)			
Crystal Silver Shade F (001 SSHA)			
<b>Color Effects</b>			
<b>Metallic Effects</b>			
Jet Hematite (280 HEM)			

2777 Concise Hexagon Flat Back

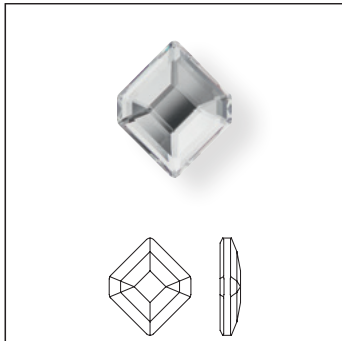

Size
5x4.2 mm
6.7x5.6 mm
10x8.4 mm

**Crystal**

Crystal F (001)

**Colors**

**Plain Colors**

Aquamarine F (202)

Black Diamond F (215)

Jet (280)

Light Siam F (227)

**Crystal Effects**

**Transparent Effects**

Crystal Aurore Boreale F (001 AB)

Crystal Silver Shade F (001 SSHA)

**Color Effects**

**Metallic Effects**

Jet Hematite (280 HEM)

Crystal F (001)	■	■	■
Aquamarine F (202)	■	■	
Black Diamond F (215)	■	■	■
Jet (280)	■	■	
Light Siam F (227)	■	■	■
Crystal Aurore Boreale F (001 AB)	■	■	■
Crystal Silver Shade F (001 SSHA)	■	■	
Jet Hematite (280 HEM)	■	■	■

**2808 Heart Flat Back**

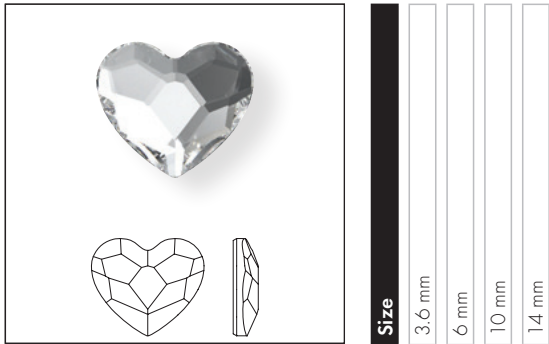

Crystal	3.6 mm	6 mm	10 mm	14 mm
Crystal F (001)	■	■	■	■
Colors				
Plain Colors				
Denim Blue F (266)		■	■	
Fuchsia F (502)		■	■	
Light Siam F (227)		■	■	
Crystal Effects				
Transparent Effects				
Crystal Aurore Boreale F (001 AB)	■	■	■	■
Crystal Golden Shadow F (001 GS HA)	■	■	■	■

**2813 Moon Flat Back**



Crystal	8x5.5 mm
Crystal F (001)	■
Crystal Effects	
Transparent Effects	
Crystal Aurore Boreale F (001 AB)	■

**2816 Rivoli Star Flat Back**

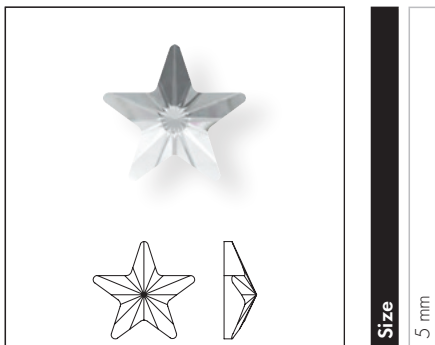

Crystal	5 mm
Crystal F (001)	■
Crystal Effects	
Transparent Effects	
Crystal Aurore Boreale F (001 AB)	■



### 2854 Butterfly Flat Back

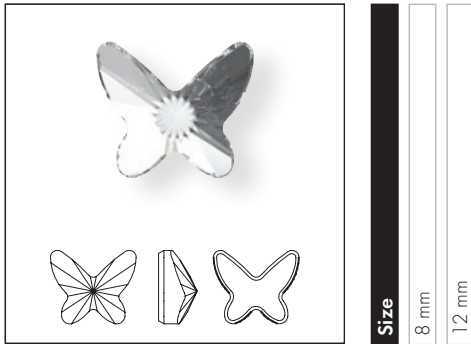

- Crystal**
- Crystal F (001)
- Colors**
- Plain Colors**
- Amethyst F (204)
- Denim Blue F (266)
- Light Rose F (223)
- Crystal Effects**
- Transparent Effects**
- Crystal Aurore Boreale F (001 AB)

### 2856 Skull Flat Back

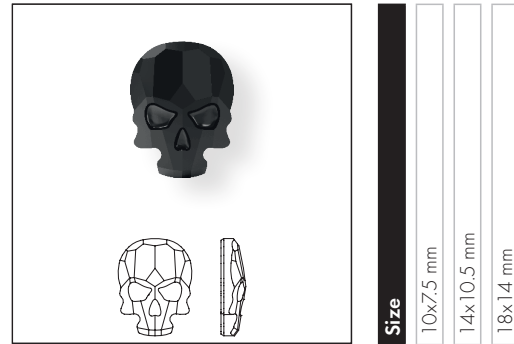

- Colors**
- Plain Colors**
- Jet (280)
- Crystal Effects**
- Transparent Effects**
- Crystal Aurore Boreale F (001 AB)
- Crystal Silver Night (001 SINI)
- Color Effects**
- Metallic Effects**
- Jet Hematite (280 HEM)

# Product Details

Product Details

Article Size	Packing Unit = Minimum Order Quantity in Pieces	Average Net Weight in Gram per Packing Unit Crystal (001)	Average Gross Weight in Gram per Packing Unit Crystal (001)
<b>1098</b>			
PP 24 (SS 12)	1440	20.96	31.16
PP 31 (SS 16)	1440	41.13	51.33
SS 20	720	36.58	46.78
SS 24	720	56.14	66.34
SS 29	288	34.19	51.37
SS 34	144	28.66	45.84
SS 39	144	39.51	56.69
<b>2000</b>			
SS 3	1,440	1.8	12.7
SS 4	1,440	3.3	13.7
<b>2019</b>			
4 mm	144	10.8	32.1
5 mm	72	10.2	29.5
6 mm	72	17.4	35.0
<b>2035</b>			
6 mm	360	27.1	34.8
10 mm	192	56.2	88.0
14 mm	96	88.4	109.0
20 mm	40	82.0	121.4
30 mm	12	95.4	130.8
40 mm	6	105.3	140.3
<b>2058</b>			
SS 5	1,440	4.4	17.9
SS 6	1,440	5.7	17.6
SS 7	1,440	7.1	19.0
SS 8	1,440	10.1	19.6
SS 9	1,440	12.4	22.0
SS 10	1,440	15.8	25.3
<b>2072</b>			
8 mm	288	92.9	119.6
10 mm	144	90.6	111.0
12 mm	72	82.0	100.1
<b>2088</b>			
SS 12	1,440	22.1	30.3
SS 14	1,440	30.1	38.3
SS 16	1,440	39.9	49.8
SS 20	1,440	72.2	80.9
SS 24	1,440	127.12	136.3
SS 30	288	34.6	63.0
SS 34	144	25.9	48.6
SS 40	144	50.0	75.1
SS 48	96	76.1	101.3
<b>2200</b>			
4x2 mm	720	6.5	18.5
8x4 mm	720	49.6	60.2

Article Size	Packing Unit = Minimum Order Quantity in Pieces	Average Net Weight in Gram per Packing Unit Crystal (001)	Average Gross Weight in Gram per Packing Unit Crystal (001)
<b>2201</b>			
4x1.8 mm	720	5.7	15.9
8x3.5 mm	144	10.03	31.11
14x6 mm	72	21.67	45.27
<b>2205</b>			
7.5 mm	288	20.3	30.5
10 mm	144	17.6	42.4
14 mm	72	22.3	45.9
<b>2300</b>			
8x4.8 mm	720	83.9	94.5
10x6 mm	360	56.9	67.8
<b>2303</b>			
8x5 mm	144	15.70	39.60
14x9 mm	72	36.65	60.25
<b>2304</b>			
10x2.8 mm	180	10.3	20.5
14x3.9 mm	96	13.1	36.3
6x1.7 mm	360	7.5	16.2
<b>2400</b>			
2.2 mm	1,440	11.3	21.7
3 mm	1,440	25.3	36.8
4 mm	720	30.0	41.0
6 mm	144	21.6	32.5
<b>2471</b>			
5 mm	288	17.3	25.6
7 mm	72	11.9	35.1
10 mm	72	30.2	51.6
<b>2472</b>			
5 mm	288	17.4	27.6
7 mm	144	20.8	42.8
10 mm	96	34.5	56.5
<b>2483</b>			
10 mm	144	90.3	120.2
25 mm	32	233.3	261.5
<b>2493</b>			
8 mm	216	72.3	91.8
10 mm	144	84.4	106.1
20 mm	24	108.5	137.9
<b>2510</b>			
3.7x1.9 mm	720	8.2	10.6
<b>2520</b>			
8x6 mm	288	50.8	80.2
10x8 mm	144	72.3	90.4
14x10 mm	144	119.3	140.8

Article Size	Packing Unit = Minimum Order Quantity in Pieces	Average Net Weight in Gram per Packing Unit Crystal (001)	Average Gross Weight in Gram per Packing Unit Crystal (001)
<b>2555</b>			
8x2.6 mm	240	18.4	27.5
12x4 mm	144	28.8	33.6
<b>2602</b>			
3.7x2.5 mm	720	11.5	21.7
8x5.5 mm	144	17.89	41.79
14x10 mm	72	58.61	82.21
<b>2603</b>			
4x3 mm	288	6.8	17.0
8x6 mm	144	21.7	43.7
14x10 mm	72	50.3	72.3
<b>2709</b>			
10x6 mm	288	48.2	73.6
13x8 mm	144	41.0	60.1
<b>2711</b>			
3.3 mm	720	10.2	16.4
<b>2715</b>			
3 mm	288	4.0	14.2
4 mm	288	8.2	18.4
<b>2716</b>			
5 mm	720	35.8	75.1
<b>2739</b>			
5.8x5.3 mm	216	19.2	41.9
7x6.5 mm	144	22.6	39.8
<b>2740</b>			
8.3x8.3 mm	216	35.1	54.2
10x10 mm	96	25.1	41.1
<b>2754</b>			
4 mm	720	13.6	23.8
6 mm	360	20.5	30.7
<b>2770</b>			
6x3.5 mm	1,440	60.3	70.3
12x7 mm	192	49.8	98.4
<b>2771</b>			
6.4x4.2 mm	288	9.04	17.87
8.6x5.6 mm	216	16.84	43.02
12.9x8.3 mm	144	36.29	61.39
<b>2772</b>			
6.5x2.1 mm	288	6.39	15.17
8.6x2.8 mm	288	16.29	40.71
12.9x4.2 mm	144	25.57	53.86
<b>2773</b>			
5x3 mm	288	4.83	13.66
6.6x3.9 mm	288	11.23	35.65
9.9x5.9 mm	144	19.30	43.39

Article Size	Packing Unit = Minimum Order Quantity in Pieces	Average Net Weight in Gram per Packing Unit Crystal (001)	Average Gross Weight in Gram per Packing Unit Crystal (001)
<b>2774</b>			
6.3x4.2 mm	288	18.7	29.6
8.3x5.6 mm	144	19.5	39.4
12.5x8.4 mm	96	39.0	60.3
<b>2775</b>			
5x4.2 mm	288	13.9	24.7
6.7x5.6 mm	144	15.0	34.3
10x8.4 mm	144	43.6	66.4
<b>2776</b>			
8.2x4.2 mm	144	11.2	30.1
11x5.6 mm	72	11.3	28.8
16.5x8.4 mm	72	35.6	55.8
<b>2777</b>			
5x4.2 mm	288	10.4	21.3
6.7x5.6 mm	144	10.5	29.7
10x8.4 mm	144	32.8	52.7
<b>2808</b>			
3.6 mm	720	18.4	20.8
6 mm	288	19.8	28.9
10 mm	144	38.8	55.9
14 mm	96	56.4	86.8
<b>2813</b>			
8x5.5 mm	144	13.1	37.7
<b>2816</b>			
5 mm	720	23.6	30.7
<b>2854</b>			
8 mm	216	36.0	52.2
12 mm	144	84.4	103.8
<b>2856</b>			
10x7.5 mm	72	20.2	38.6
14x10.5 mm	36	30.2	50.3
18x14 mm	30	53.0	83.4

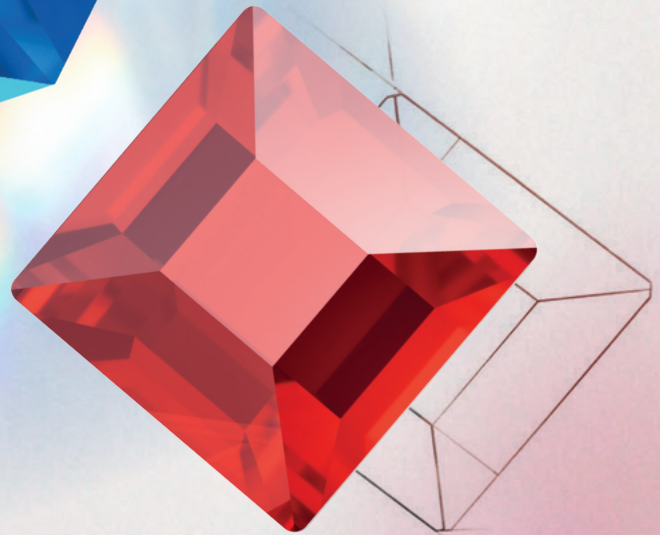

# Flat Backs Hotfix

Flat Backs Hotfix possess a flat reverse side, and are pre-coated with a heat sensitive glue. They are easily applied to a large range of textiles producing a shimmering, durable and long-lasting design.

The captivating beauty of the Flat Back Rose, Xilion and Xirius Rose is crafted by a unique silver mirror coating on its reverse side, resulting in amplified light reflection and a warmer appearance.

The most coveted and famous item in this product group is article 2078 XIRIUS Rose. Incredibly progressive, and completely unique, multi-layer cutting technology is used to create the inspiring XIRIUS star design, allowing for superior shine, and rich, well-balanced light refraction, redefining the market standard.

Swarovski's outstanding quality is underlined by the highest precision in table size and diameter.

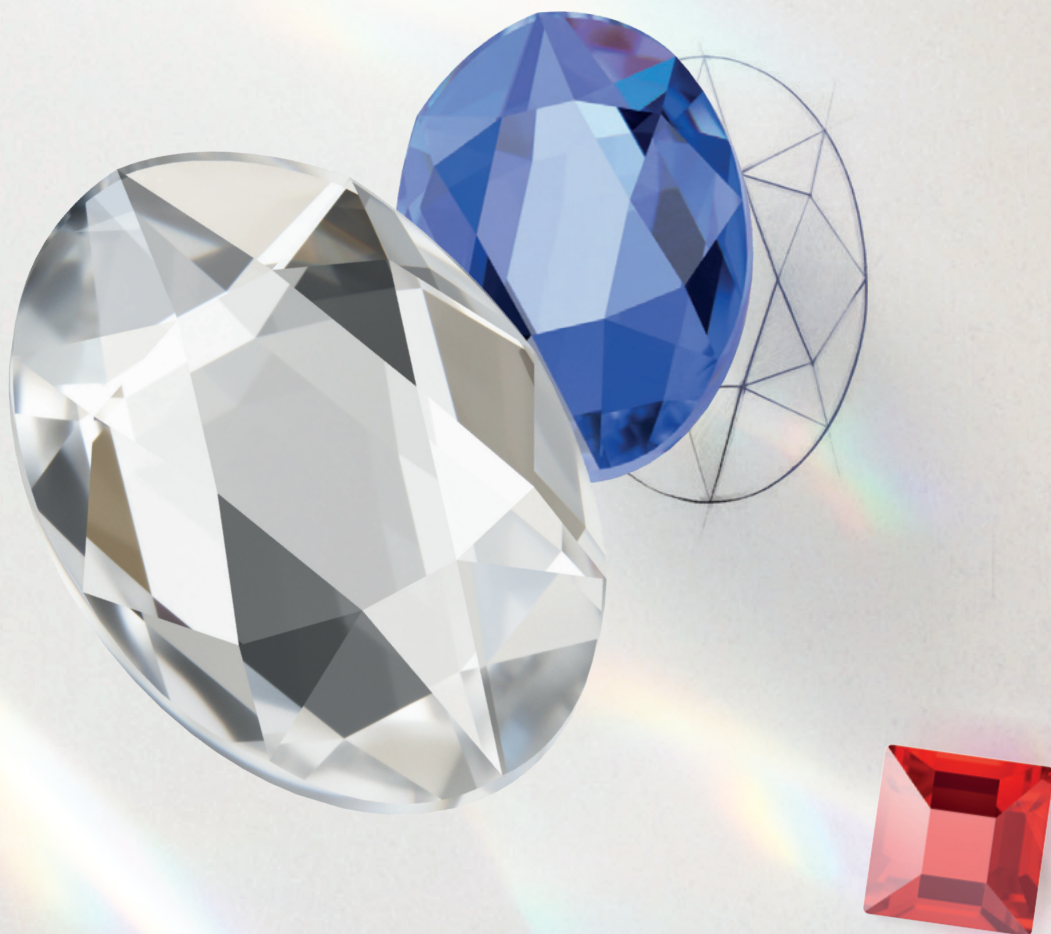



























































## Colors & Effects

OPEN TO SEE COLORS & EFFECTS







## Colors

-  Crystal 001
-  Crystal Hotfix Transparent 001 HFT
-  White Opal 234
-  Light Silk 261
-  Silk 391
-  Light Peach 362
-  Vintage Rose 319
-  Blush Rose 257
-  Light Rose 223
-  Rose Peach 262
-  Padparadscha 542
-  Indian Pink 289
-  Rose 209
-  Fuchsia 502
-  Light Siam 227
-  Scarlet 276
-  Indian Siam 327
-  Siam 208
-  Ruby 501
-  Burgundy 515
-  Amethyst 204
-  Iris 219
-  Light Amethyst 212
-  Provence Lavender 283
-  Tanzanite 539
-  Purple Velvet 277
-  Aquamarine 202
-  Light Sapphire 211



-  Sapphire 206
-  Capri Blue 243
-  Majestic Blue 296
-  Cobalt 369
-  Dark Indigo 288
-  Montana 207
-  Denim Blue 266
-  Indicolite 379
-  Light Turquoise 263
-  Blue Zircon 229
-  Erinite 360
-  Chrysolite 238
-  Peridot 214
-  Citrus Green 337
-  Fern Green 291
-  Emerald 205
-  Jonquil 213
-  Light Topaz 226
-  Golden Topaz 1003
-  Light Colorado Topaz 246
-  Topaz 203
-  Light Amber 1002
-  Smoked Amber 1001
-  Greige 284
-  Black Diamond 215
-  Graphite 253
-  Jet 280

## Effects







-  Crystal Moonlight 001 MOL
-  Crystal Shimmer 001 SHIM
-  Crystal Transmission Hotfix Transparent 001 TRA HFT
-  Crystal Aurore Boreale 001 AB
-  Crystal Paradise Shine 001 PARSH
-  Crystal Volcano 001 VOL
-  Crystal Blue Shade 001 BLSH
-  Crystal Golden Shadow 001 GSHA
-  Crystal Metallic Sunshine 001 METSH
-  Crystal Rose Gold 001 ROGL
-  Crystal Light Chrome 001 LTCH
-  Crystal Silver Shade 001 SSHA
-  Crystal Silver Night 001 SINI
-  Jet Hematite 280 HEM

## Crystal Lacquer<sup>PRO</sup> Effects

### Crystal Lacquer<sup>PRO</sup> Ignite Effects

-  Crystal Linen Ignite  
001 L164I
-  Crystal Flamingo Ignite  
001 L162I
-  Crystal Orange Ignite  
001 L159I
-  Crystal Maroon Ignite  
001 L160I
-  Crystal Purple Ignite  
001 L161I
-  Crystal Sky Ignite  
001 L163I





### Crystal Electric Lacquer<sup>PRO</sup> Effects

-  Crystal Electric White  
001 L139S
-  Crystal Electric Orange  
001 L136S
-  Crystal Electric Pink  
001 L137S
-  Crystal Electric Violet  
001 L148S
-  Crystal Electric Blue  
001 L134S
-  Crystal Electric Green  
001 L135S
-  Crystal Electric Yellow  
001 L138S

## Shimmer Effects

-  Silk Shimmer  
391 SHIM
-  Light Rose Shimmer  
223 SHIM
-  Fuchsia Shimmer  
502 SHIM
-  Light Siam Shimmer  
227 SHIM
-  Tanzanite Shimmer  
539 SHIM
-  Light Sapphire Shimmer  
211 SHIM
-  Blue Zircon Shimmer  
229 SHIM
-  Peridot Shimmer  
214 SHIM
-  Topaz Shimmer  
203 SHIM
-  Black Diamond Shimmer  
215 SHIM

## AB Effects

-  Light Rose Aurore Boreale  
223 AB
-  Light Siam Aurore Boreale  
227 AB
-  Sapphire Aurore Boreale  
206 AB
-  Jonquil Aurore Boreale  
213 AB
-  Jet Aurore Boreale  
280 AB

## Nightfall Effects

-  Siam Nightfall  
208 NIFA
-  Capri Blue Nightfall  
243 NIFA
-  Emerald Nightfall  
205 NIFA
-  Graphite Nightfall  
253 NIFA

## Cabochons

-  Crystal White Pearl  
001 650
-  Crystal Nacre  
001 191
-  Crystal Creampearl  
001 291
-  Crystal Golden Shadow  
001 GSHA
-  Crystal Rosaline Pearl  
001 294
-  Crystal Dark Grey Pearl  
001 617
-  Jet  
280
-  Jet Hematite  
280 HEM

## Rimmed Flat Backs

-  Jet Light Chrome Z  
280 LTCHZ

## Numerical Order

001	Crystal	204	Amethyst	261	Light Silk
001 191	Crystal Nacre	205 NIFA	Emerald Nightfall	262	Rose Peach
001 291	Crystal Creampearl	205	Emerald	263	Light Turquoise
001 294	Crystal Rosaline Pearl	206 AB	Sapphire Aurore Boreale	266	Denim Blue
001 617	Crystal Dark Grey Pearl	206	Sapphire	276	Scarlet
001 650	Crystal White Pearl	207	Montana	277	Purple Velvet
001 AB	Crystal Aurore Boreale	208 NIFA	Siam Nightfall	280 AB	Jet Aurore Boreale
001 BLSH	Crystal Blue Shade	208	Siam	280 HEM	Jet Hematite
001 GSHA	Crystal Golden Shadow	209	Rose	280 LTCHZ	Jet Light Chrome Z
001 HFT	Crystal Hotfix Transparent	211 SHIM	Light Sapphire Shimmer	280	Jet
001 LI34S	Crystal Electric Blue	211	Light Sapphire	283	Provence Lavender
001 LI35S	Crystal Electric Green	212	Light Amethyst	284	Greige
001 LI36S	Crystal Electric Orange	213 AB	Jonquil Aurore Boreale	288	Dark Indigo
001 LI37S	Crystal Electric Pink	213	Jonquil	289	Indian Pink
001 LI38S	Crystal Electric Yellow	214 SHIM	Peridot Shimmer	291	Fern Green
001 LI39S	Crystal Electric White	214	Peridot	296	Majestic Blue
001 LI48S	Crystal Electric Violet	215 SHIM	Black Diamond Shimmer	319	Vintage Rose
001 LI59I	Crystal Orange Ignite	215	Black Diamond	327	Indian Siam
001 LI60I	Crystal Maroon Ignite	219	Iris	337	Citrus Green
001 LI61I	Crystal Purple Ignite	223 AB	Light Rose Aurore Boreale	360	Erinite
001 LI62I	Crystal Flamingo Ignite	223 SHIM	Light Rose Shimmer	362	Light Peach
001 LI63I	Crystal Sky Ignite	223	Light Rose	369	Cobalt
001 LI64I	Crystal Linen Ignite	226	Light Topaz	379	Indicolite
001 LTCH	Crystal Light Chrome	227 AB	Light Siam Aurore Boreale	391 SHIM	Silk Shimmer
001 METSH	Crystal Metallic Sunshine	227 SHIM	Light Siam Shimmer	391	Silk
001 MOL	Crystal Moonlight	227	Light Siam	501	Ruby
001 PARSH	Crystal Paradise Shine	229 SHIM	Blue Zircon Shimmer	502 SHIM	Fuchsia Shimmer
001 ROGL	Crystal Rose Gold	229	Blue Zircon	502	Fuchsia
001 SHIM	Crystal Shimmer	234	White Opal	515	Burgundy
001 SINI	Crystal Silver Night	238	Chrysolite	539 SHIM	Tanzanite Shimmer
001 SSHA	Crystal Silver Shade	243 NIFA	Capri Blue Nightfall	539	Tanzanite
001 TRA HFT	Crystal Transmission Hotfix Transparent	243	Capri Blue	542	Padparadscha
001 VOL	Crystal Volcano	246	Light Colorado Topaz	1001	Smoked Amber
202	Aquamarine	253 NIFA	Graphite Nightfall	1002	Light Amber
203 SHIM	Topaz Shimmer	253	Graphite	1003	Golden Topaz
203	Topaz	257	Blush Rose		

## Alphabetical Order

Amethyst (204)	Crystal Purple Ignite (001 L1611)	Light Rose (223)
Aquamarine (202)	Crystal Rosaline Pearl (001 294)	Light Rose Aurore Boreale (223 AB)
Black Diamond (215)	Crystal Rose Gold (001 ROGL)	Light Rose Shimmer (223 SHIM)
Black Diamond Shimmer (215 SHIM)	Crystal Shimmer (001 SHIM)	Light Sapphire (211)
Blue Zircon (229)	Crystal Silver Night (001 SINI)	Light Sapphire Shimmer (211 SHIM)
Blue Zircon Shimmer (229 SHIM)	Crystal Silver Shade (001 SSHA)	Light Siam (227)
Blush Rose (257)	Crystal Sky Ignite (001 L1631)	Light Siam Aurore Boreale (227 AB)
Burgundy (515)	Crystal Transmission Hotfix Transparent (001 TRA HFT)	Light Siam Shimmer (227 SHIM)
Capri Blue (243)	Crystal Volcano (001 VOL)	Light Silk (261)
Capri Blue Nightfall (243 NIFA)	Crystal White Pearl (001 650)	Light Topaz (226)
Chrysolite (238)	Dark Indigo (288)	Light Turquoise (263)
Citrus Green (337)	Denim Blue (266)	Majestic Blue (296)
Cobalt (369)	Emerald (205)	Montana (207)
Crystal (001)	Emerald Nightfall (205 NIFA)	Padparadscha (542)
Crystal Aurore Boreale (001 AB)	Erinite (360)	Peridot (214)
Crystal Blue Shade (001 BLSH)	Fern Green (291)	Peridot Shimmer (214 SHIM)
Crystal Creampearl (001 291)	Fuchsia (502)	Provence Lavender (283)
Crystal Dark Grey Pearl (001 617)	Fuchsia Shimmer (502 SHIM)	Purple Velvet (277)
Crystal Electric Blue (001 L134S)	Golden Topaz (1003)	Rose (209)
Crystal Electric Green (001 L135S)	Graphite (253)	Rose Peach (262)
Crystal Electric Orange (001 L136S)	Graphite Nightfall (253 NIFA)	Ruby (501)
Crystal Electric Pink (001 L137S)	Greige (284)	Sapphire (206)
Crystal Electric Violet (001 L148S)	Indian Pink (289)	Sapphire Aurore Boreale (206 AB)
Crystal Electric White (001 L139S)	Indian Siam (327)	Scarlet (276)
Crystal Electric Yellow (001 L138S)	Indicolite (379)	Siam (208)
Crystal Flamingo Ignite (001 L1621)	Iris (219)	Siam Nightfall (208 NIFA)
Crystal Golden Shadow (001 GSHA)	Jet (280)	Silk (391)
Crystal Hotfix Transparent (001 HFT)	Jet Aurore Boreale (280 AB)	Silk Shimmer (391 SHIM)
Crystal Light Chrome (001 LTCH)	Jet Hematite (280 HEM)	Smoked Amber (1001)
Crystal Linen Ignite (001 L1641)	Jet Light Chrome Z (280 LTCHZ)	Tanzanite (539)
Crystal Maroon Ignite (001 L1601)	Jonquil (213)	Tanzanite Shimmer (539 SHIM)
Crystal Metallic Sunshine (001 METSH)	Jonquil Aurore Boreale (213 AB)	Topaz (203)
Crystal Moonlight (001 MOL)	Light Amber (1002)	Topaz Shimmer (203 SHIM)
Crystal Nacre (001 191)	Light Amethyst (212)	Vintage Rose (319)
Crystal Orange Ignite (001 L1591)	Light Colorado Topaz (246)	White Opal (234)
Crystal Paradise Shine (001 PARSH)	Light Peach (362)	

03

For details on available colors and effects for each article within the product groups, please see the product matrix of the respective item in the Collection 2023.













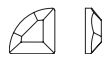



















The plating resistance of effects is tested according to Swarovski's plating guidelines (SWAROVSKI.COM/S-PROFESSIONALS). Customers are advised to carry out their own tests if their plating parameters diverge from Swarovski plating guidelines.

Colors and effects can appear different when illuminated with different light sources. Swarovski uses standard light source D65 for color decision and comparison. Slight changes in shades are unavoidable. Colors may vary according to cut and foiling.

The composition of Advanced Crystal is compliant with regulatory industry norms and laws regarding the restriction or prohibition of certain substances in the most relevant segments of our customers. Please note that the compliance of the colors Light Siam and Siam varies according to certain industry regulations. Those regulations are indicated with \* in the compliance overview. Indian Siam, Ruby and Scarlet (option to Lt. Siam) conform to all CLEAR-lists. For further information please visit [swarovski.com/s-professionals](https://www.swarovski.com/s-professionals)

© 2023 D. Swarovski Distribution GmbH

# Summary

1 2 3		<b>1098 A HF</b> PP 24 (SS 12), PP 31 (SS 16) SS 20	1 2		<b>2303 M HF</b> 8x5, 14x9 mm	1 2		<b>2715 M HF</b> 3, 4 mm
		<b>2000 A HF</b> SS 3			<b>2304 M HF</b> 10x2.8, 14x3.9 mm			<b>2738 M HF</b> 10x5, 12x6 mm
		<b>2038 A HF</b> SS 5, 6, 8, 10			<b>2400 M HF</b> 2.2, 3, 4, 6 mm			<b>2739 M HF</b> 5.8x5.3, 7x6.5 mm
		<b>2038/1 A HF</b> SS 10			<b>2471 M HF</b> 5, 7, 10 mm			<b>2740 M HF</b> 8.3x8.3, 10x10 mm
		<b>2078 A HF</b> SS 12, 16, 20, 30, 34, 40, 48			<b>2472 M HF</b> 5, 7, 10 mm			<b>2754 M HF</b> 4, 6 mm
		<b>2078/1 A HF</b> SS 16, 20			<b>2510 M HF</b> 3.7x1.9, 5x2.5 mm			<b>2770 M HF</b> 6x3.5 mm
		<b>2080/4 HF</b> SS 6, 10, 16, 20, 34			<b>2555 M HF</b> 8x2.6, 12x4 mm			<b>2771 M HF</b> 6.4x4.2, 8.6x5.6, 12.9x8.3 mm
		<b>2200 HF</b> 4x2, 8x4 mm			<b>2602 M HF</b> 3.7x2.5, 8x5.5, 14x10 mm			<b>2772 M HF</b> 6.5x2.1, 8.6x2.8, 12.9x4.2 mm
		<b>2201 M HF</b> 4x1.8, 8x3.5, 14x6 mm			<b>2603 M HF</b> 4x3, 8x6, 14x10 mm			<b>2773 M HF</b> 5x3, 6.6x3.9, 9.9x5.9 mm
		<b>2205 M HF</b> 7.5, 10, 14 mm			<b>2709 M HF</b> 10x6 mm			<b>2774 M HF</b> 6.3x4.2, 8.3x5.6, 12.5x8.4 mm
		<b>2300 M HF</b> 8x4.8 mm			<b>2711 M HF</b> 3.3, 6 mm			<b>2775 M HF</b> 5x4.2, 6.7x5.6, 10x8.4 mm

1 Top view 2 Side view 3 Back view



1 2



**2776 M HF**  
8.2x4.2, 11x5.6,  
16.5x8.4 mm



**2777 M HF**  
5x4.2, 6.7x5.6,  
10x8.4 mm



**2788 M HF**  
8 mm



**2808 M HF**  
3.6, 6, 10 mm



**2813 M HF**  
8x5.5 mm



**2816 M HF**  
5 mm

**1098 XIRIUS Light**

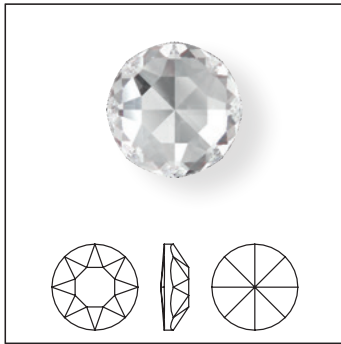

Size	PP 24   SS 12	PP 31   SS 16	SS 20
------	---------------	---------------	-------

**Crystal**

Crystal A HF (001)

**Crystal Effects**

**Transparent Effects**

Crystal Aurore Boreale A HF (001 AB)

Crystal Golden Shadow A HF (001 GSHA)

Crystal Silver Night A HF (001 SINI)

Crystal Silver Shade A HF (001 SSHA)

2000 Rose

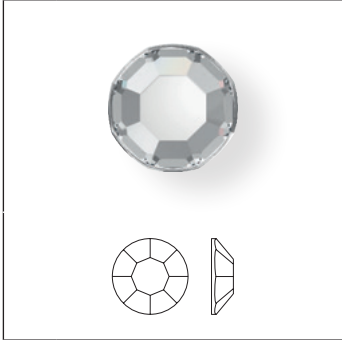

Size SS 3

2038 XILION Rose

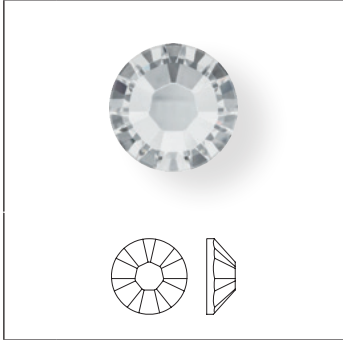

Size SS 5, 6, 8, 10

2078 XIRIUS Rose

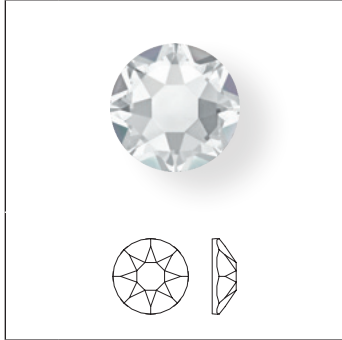

Size SS 12, 16, 20, 30, 34, 40, 48

	2000 Rose	2038 XILION Rose	2078 XIRIUS Rose
<b>Crystal</b>			
Crystal Hotfix Transparent (001 HFT)	■	■	■
Crystal A HF (001)	■	■	■
<b>Colors</b>			
<b>Plain Colors</b>			
Amethyst A HF (204)	■	■	■
Aquamarine A HF (202)	■	■	■
Black Diamond A HF (215)	■	■	■
Blue Zircon A HF (229)	■	■	■
Blush Rose A HF (257)	■	■	■
Burgundy A HF (515)	■	■	■
Capri Blue A HF (243)	■	■	■
Chrysolite A HF (238)	■	■	■
Citrus Green A HF (337)	■	■	■
Cobalt A HF (369)	■	■	■
Dark Indigo A HF (288)	■	■	■
Denim Blue A HF (266)	■	■	■
Emerald A HF (205)	■	■	■

	2000				2038				2078							
	Size	2000 Rose	SS 3	2038 XILION Rose	SS 5	SS 6	SS 8	SS 10	2078 XIRIUS Rose	SS 12	SS 16	SS 20	SS 30	SS 34	SS 40	SS 48
Erinite A HF (360)																
Fern Green A HF (291)																
Fuchsia A HF (502)																
Golden Topaz A HF (1003)*																
Graphite A HF (253)																
Greige A HF (284)																
Indian Pink A HF (289)																
Indian Siam A HF (327)																
Indicolite A HF (379)																
Iris A HF (219)																
Jet HFT (280)																
Jet A HF (280)																
Jonquil A HF (213)																
Light Amber A HF (1002)*																
Light Amethyst A HF (212)																
Light Colorado Topaz A HF (246)																
Light Peach A HF (362)																
Light Rose A HF (223)																
Light Sapphire A HF (211)																
Light Siam A HF (227)																
Light Silk A HF (261)																
Light Topaz A HF (226)																
Light Turquoise A HF (263)																
Majestic Blue A HF (296)																
Montana A HF (207)																
Padparadscha A HF (542)																
Peridot A HF (214)																
Provence Lavender A HF (283)																
Purple Velvet A HF (277)																
Rose A HF (209)																
Rose Peach A HF (262)																
Ruby A HF (501)																

\* All colors with a 4-digit color code (i.e. Golden Topaz) are fully customizable with shorter lead times and lower MOQs compared to our 3-digit colors. Please get in touch with the Customer Service for a time and quantity estimation of your desired variant.

	Size	2000 Rose	SS 3	2038 XILION Rose	SS 5	SS 6	SS 8	SS 10	2078 XIRIUS Rose	SS 12	SS 16	SS 20	SS 30	SS 34	SS 40	SS 48
<div style="border: 1px solid black; padding: 5px; display: inline-block;"> <p><b>2000</b> <b>2038</b> <b>2078</b></p> </div>																
● Sapphire A HF (206)			■		■	■	■	■		■	■	■		■		
● Scarlet A HF (276)					■	■	■	■		■	■	■		■		
● Siam A HF (208)					■	■	■	■		■	■	■		■		
● Silk A HF (391)		■			■	■	■	■		■	■	■		■		
● Smoked Amber A HF (1001)*		■			■	■	■	■		■	■	■		■		
● Tanzanite A HF (539)		■			■	■	■	■		■	■	■		■		
● Topaz A HF (203)					■	■	■	■		■	■	■		■		
● Vintage Rose A HF (319)		■			■	■	■	■		■	■	■		■		
<b>Opal Colors</b>																
● White Opal A HF (234)						■	■	■		■	■	■		■		
<b>Crystal Effects</b>																
<b>Transparent Effects</b>																
● Crystal Aurore Boreale A HF (001 AB)		■		■	■	■	■	■		■	■	■	■	■	■	■
● Crystal Blue Shade A HF (001 BLSH)						■	■	■		■	■	■		■		
● Crystal Golden Shadow A HF (001 GSHA)		■			■	■	■	■		■	■	■		■		
● Crystal Moonlight A HF (001 MOL)		■			■	■	■	■		■	■	■		■		
● Crystal Paradise Shine A HF (001 PARSH)		■			■	■	■	■		■	■	■		■		
● Crystal Shimmer A HF (001 SHIM)		■			■	■	■	■		■	■	■		■		
● Crystal Silver Night A HF (001 SINI)		■			■	■	■	■		■	■	■		■		
● Crystal Silver Shade A HF (001 SSHA)		■			■	■	■	■		■	■	■		■		
● Crystal Transmission HFT (001 TRA HFT)		■			■	■	■	■		■	■	■		■		
● Crystal Volcano A HF (001 VOL)					■	■	■	■		■	■	■		■		
<b>Metallic Effects</b>																
● Crystal Light Chrome A HF (001 LTCH)		■			■	■	■	■		■	■	■		■		
● Crystal Metallic Sunshine A HF (001 METSH)		■			■	■	■	■		■	■	■		■		
● Crystal Rose Gold A HF (001 ROGL)		■			■	■	■	■		■	■	■		■		
<b>Crystal Lacquer<sup>PRO</sup> Effects</b>																
<b>Crystal Lacquer<sup>PRO</sup> Ignite Effects</b>																
● Crystal Flamingo Ignite HFT (001 L162I)								■		■	■			■		
● Crystal Linen Ignite HFT (001 L164I)								■		■	■			■		
● Crystal Maroon Ignite HFT (001 L160I)								■		■	■			■		
● Crystal Orange Ignite HFT (001 L159I)								■		■	■			■		
● Crystal Purple Ignite HFT (001 L161I)								■		■	■			■		
● Crystal Sky Ignite HFT (001 L163I)								■		■	■			■		

\* All colors with a 4-digit color code (i.e. Golden Topaz) are fully customizable with shorter lead times and lower MOQs compared to our 3-digit colors. Please get in touch with the Customer Service for a time and quantity estimation of your desired variant.

	Size	2000 Rose	SS 3	2038 XILION Rose	SS 5	SS 6	SS 8	SS 10	2078 XIRIUS Rose	SS 12	SS 16	SS 20	SS 30	SS 34	SS 40	SS 48
<b>2000 2038 2078</b>																
<b>Crystal Electric Lacquer<sup>PRO</sup> Effects</b>																
	Crystal Electric Blue HFT (001 L134S)							■		■	■	■				
	Crystal Electric Green HFT (001 L135S)							■		■	■	■				
	Crystal Electric Orange HFT (001 L136S)							■		■	■	■				
	Crystal Electric Pink HFT (001 L137S)							■		■	■	■				
	Crystal Electric Violet HFT (001 L148S)							■		■	■	■				
	Crystal Electric White HFT (001 L139S)							■		■	■	■				
	Crystal Electric Yellow HFT (001 L138S)							■		■	■	■				
<b>Color Effects</b>																
<b>Transparent Effects</b>																
	Black Diamond Shimmer A HF (215 SHIM)	■			■			■		■	■			■		
	Blue Zircon Shimmer A HF (229 SHIM)					■		■		■	■			■		
	Capri Blue Nightfall A HF (243 NIFA)							■		■	■			■		
	Emerald Nightfall A HF (205 NIFA)							■		■	■			■		
	Fuchsia Shimmer A HF (502 SHIM)							■		■	■			■		
	Graphite Nightfall A HF (253 NIFA)							■		■	■			■		
	Jet AB A HF (253 NIFA)	■			■			■		■	■			■		
	Jonquil AB A HF (213 AB)	■			■			■		■	■			■		
	Light Rose AB A HF (223 AB)							■		■	■			■		
	Light Rose Shimmer A HF (223 SHIM)	■			■			■		■	■			■		
	Light Sapphire Shimmer A HF (211 SHIM)							■		■	■			■		
	Light Siam AB A HF (227 AB)	■			■			■		■	■			■		
	Light Siam Shimmer A HF (227 SHIM)	■			■			■		■	■			■		
	Peridot Shimmer A HF (214 SHIM)							■		■	■			■		
	Sapphire AB A HF (206 AB)	■			■			■		■	■			■		
	Siam Nightfall A HF (208 NIFA)							■		■	■			■		
	Silk Shimmer A HF (391 SHIM)	■			■			■		■	■			■		
	Tanzanite Shimmer A HF (539 SHIM)	■			■			■		■	■			■		
	Topaz Shimmer A HF (203 SHIM)							■		■	■			■		
<b>Metallic Effects</b>																
	Jet Hematite A HF (280 HEM)	■			■	■	■	■		■	■			■		

\* All colors with a 4-digit color code (i.e. Golden Topaz) are fully customizable with shorter lead times and lower MOQs compared to our 3-digit colors. Please get in touch with the Customer Service for a time and quantity estimation of your desired variant.

2038/I Rimmed Flat Back

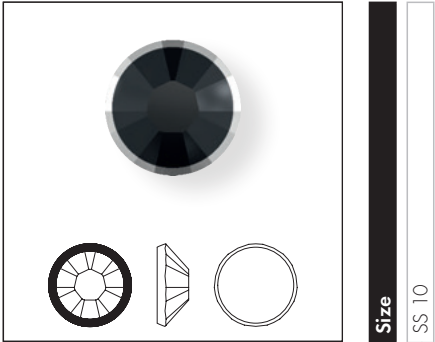

Size  
SS 10

Color Effects

Metallic Effects

Jet & Light Chrome Z A HF (280 ITCHZ)

2078/I Rimmed Flat Back

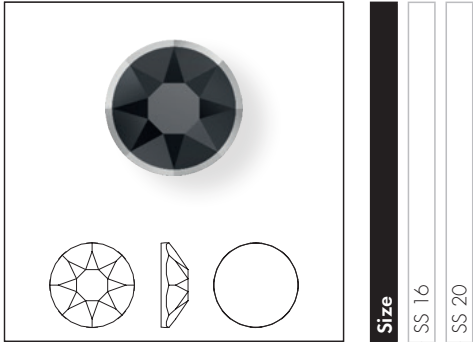

Size  
SS 16  
SS 20

Color Effects

Metallic Effects

Jet & Light Chrome Z A HF (280 ITCHZ)

## CABOCHON

### 2080/4 Cabochon



Size	SS 6	SS 10	SS 16	SS 20	SS 34
------	------	-------	-------	-------	-------

#### Colors

##### Plain Colors

● Jet M HF (280)

##### Crystal Effects

##### Transparent Effects

● Crystal Golden Shadow HF (001 GSHA)

##### Color Effects

##### Metallic Effects

● Jet Hematite M HF (280 HEM)

##### Pearl Colors

● Crystal Creampearl HF (001 CMPRL)

● Crystal Dark Grey Pearl HF (001 DGREY)

● Crystal Nacre HF (001 NACRE)

● Crystal Rosaline Pearl HF (001 ROPRL)

● Crystal White Pearl HF (001 WHITE)

Jet M HF (280)	■	■	■	■	■
Crystal Golden Shadow HF (001 GSHA)	■	■	■	■	■
Jet Hematite M HF (280 HEM)	■	■	■	■	■
Crystal Creampearl HF (001 CMPRL)	■	■	■	■	■
Crystal Dark Grey Pearl HF (001 DGREY)	■	■	■	■	■
Crystal Nacre HF (001 NACRE)	■	■	■	■	■
Crystal Rosaline Pearl HF (001 ROPRL)	■	■	■	■	■
Crystal White Pearl HF (001 WHITE)	■	■	■	■	■



### 2200 Navette Flat Back

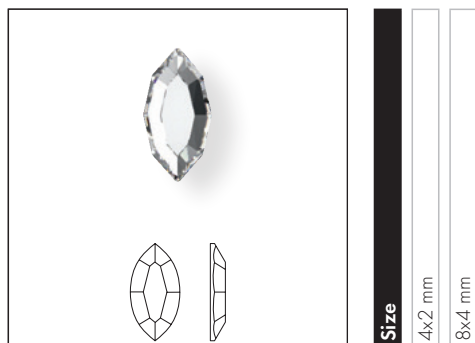

Crystal	
Crystal M HF (001)	<input type="checkbox"/>
Colors	
Plain Colors	
Aquamarine M HF (202)	<input type="checkbox"/>
Black Diamond M HF (215)	<input type="checkbox"/>
Emerald M HF (205)	<input type="checkbox"/>
Jet M HF (280)	<input type="checkbox"/>
Light Colorado Topaz M HF (246)	<input type="checkbox"/>
Light Rose M HF (223)	<input type="checkbox"/>
Scarlet M HF (276)	<input type="checkbox"/>
Crystal Effects	
Transparent Effects	
Crystal Aurore Boreale M HF (001 AB)	<input type="checkbox"/>
Crystal Golden Shadow M HF (001 GSHA)	<input type="checkbox"/>
Crystal Silver Shade M HF (001 SSHA)	<input type="checkbox"/>

### 2201 Marquise Flat Back

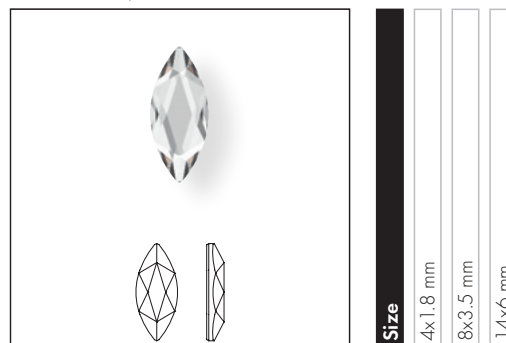

Crystal	
Crystal M HF (001)	<input type="checkbox"/>
Crystal Effects	
Transparent Effects	
Crystal Aurore Boreale M HF (001 AB)	<input type="checkbox"/>
Crystal Golden Shadow M HF (001 GSHA)	<input type="checkbox"/>

**2205 Flame Flat Back**

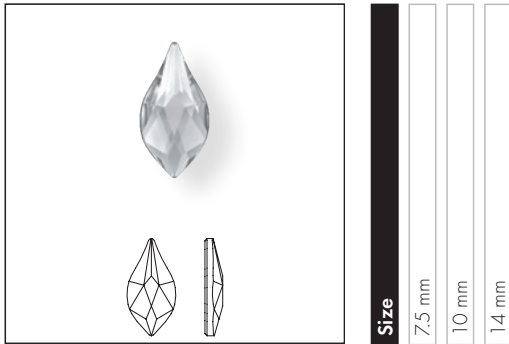

**Size**  
7,5 mm  
10 mm  
14 mm

**Crystal**

Crystal M HF (001)

**Crystal Effects**

**Transparent Effects**

Crystal Aurore Boreale M HF (001 AB)

Crystal Golden Shadow M HF (001 GSHA)

**2300 Drop Flat Back**

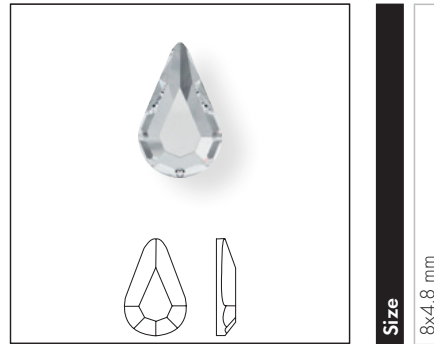

**Size**  
8x4.8 mm

**Crystal**

Crystal M HF (001)

**Colors**

**Plain Colors**

Aquamarine M HF (202)

Black Diamond M HF (215)

Emerald M HF (205)

Jet M HF (280)

Light Colorado Topaz M HF (246)

Light Rose M HF (223)

Scarlet M HF (276)

**Crystal Effects**

**Transparent Effects**

Crystal Aurore Boreale M HF (001 AB)

Crystal Golden Shadow M HF (001 GSHA)

**2303 Pear Flat Back**

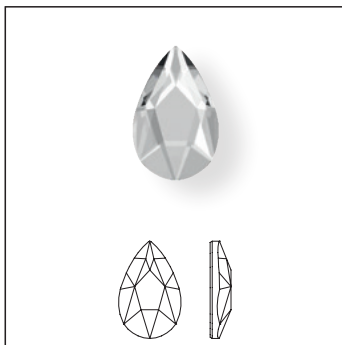

**Size**  
8x5 mm  
14x9 mm

**Crystal**

Crystal M HF (001)

**Crystal Effects**

**Transparent Effects**

Crystal Aurore Boreale M HF (001 AB)

Crystal Golden Shadow M HF (001 GSHA)

**2304 Raindrop Flat Back**

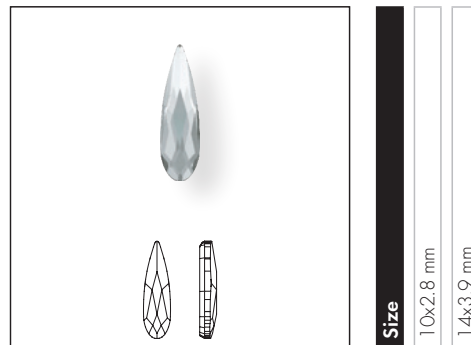

**Size**  
10x2.8 mm  
14x3.9 mm

**Crystal**

Crystal M HF (001)

**Crystal Effects**

**Transparent Effects**

Crystal Aurore Boreale M HF (001 AB)

Crystal Golden Shadow M HF (001 GSHA)

### 2400 Square Flat Back



**Size**  
2.2 mm  
3 mm  
4 mm  
6 mm

Crystal	2.2 mm	3 mm	4 mm	6 mm
Crystal M HF (001)	■	■	■	■
Colors				
Plain Colors				
Amethyst M HF (204)		■	■	
Aquamarine M HF (202)		■	■	
Black Diamond M HF (215)		■	■	
Emerald M HF (205)		■	■	
Jet M HF (280)		■	■	■
Light Colorado Topaz M HF (246)		■	■	
Light Rose M HF (223)		■	■	
Scarlet M HF (276)		■	■	
Crystal Effects				
Transparent Effects				
Crystal Aurore Boreale M HF (001 AB)	■	■	■	■
Crystal Golden Shadow M HF (001 GSHA)	■	■	■	■
Crystal Silver Night M HF (001 SINI)		■	■	
Color Effects				
Metallic Effects				
Jet Hematite M HF (280 HEM)		■	■	

### 2471 Cushion Flat Back



**Size**  
5 mm  
7 mm  
10 mm

Crystal	5 mm	7 mm	10 mm
Crystal M HF (001)	■	■	■
Colors			
Plain Colors			
Aquamarine M HF (202)	■	■	■
Emerald M HF (205)	■	■	■
Graphite M HF (253)	■	■	■
Jet M HF (280)	■	■	■
Sapphire M HF (206)	■	■	■
Scarlet M HF (276)	■	■	■
Vintage Rose M HF (319)	■	■	■
Crystal Effects			
Transparent Effects			
Crystal Aurore Boreale M HF (001 AB)	■	■	■
Crystal Golden Shadow M HF (001 GSHA)	■	■	■

### 2472 Trilliant Flat Back

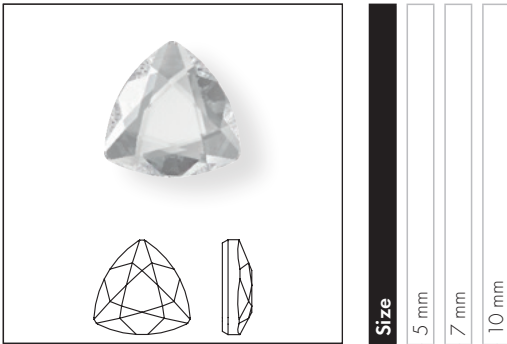

**Size**  
5 mm  
7 mm  
10 mm

Crystal	5 mm	7 mm	10 mm
Crystal M HF (001)	■	■	■
Colors			
Plain Colors			
Aquamarine M HF (202)	■	■	■
Emerald M HF (205)	■	■	■
Graphite M HF (253)	■	■	■
Jet M HF (280)	■	■	■
Sapphire M HF (206)	■	■	■
Scarlet M HF (276)	■	■	■
Vintage Rose M HF (319)	■	■	■
Crystal Effects			
Transparent Effects			
Crystal Aurore Boreale M HF (001 AB)	■	■	■
Crystal Golden Shadow M HF (001 GSHA)	■	■	■

### 2510 Baguette Flat Back

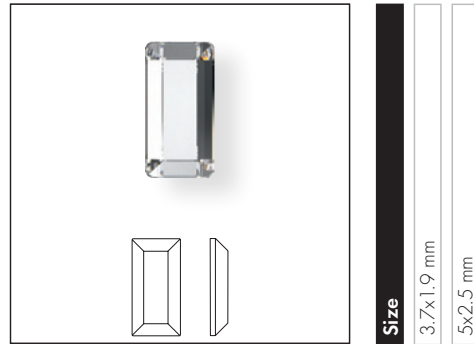

**Size**  
3.7x1.9 mm  
5x2.5 mm

Crystal	3.7x1.9 mm	5x2.5 mm
Crystal M HF (001)	■	■
Colors		
Plain Colors		
Aquamarine M HF (202)	■	■
Black Diamond M HF (215)	■	■
Emerald M HF (205)	■	■
Jet M HF (280)	■	■
Light Colorado Topaz M HF (246)	■	■
Crystal Effects		
Transparent Effects		
Crystal Aurore Boreale M HF (001 AB)	■	■
Crystal Golden Shadow M HF (001 GSHA)	■	■

### 2555 Cosmic Baguette Flat Back

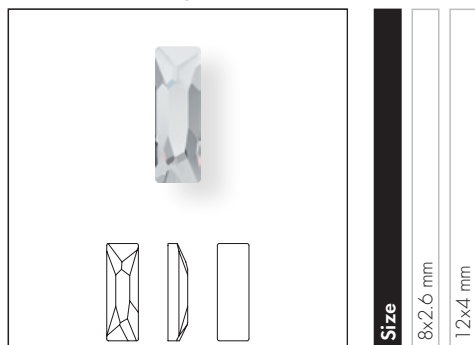

**Size**

8x2.6 mm

12x4 mm

**Crystal**

Crystal M HF (001)

**Crystal Effects**

**Transparent Effects**

Crystal Aurore Boreale M HF (001 AB)

Crystal Golden Shadow M HF (001 GSHA)

### 2602 Emerald Cut Flat Back

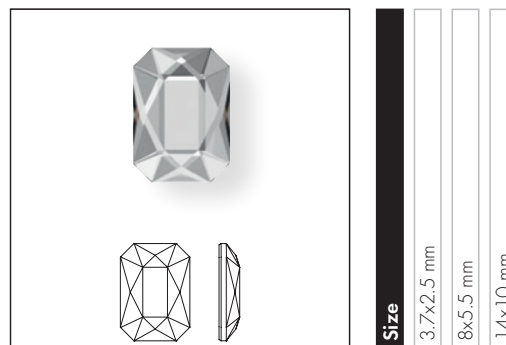

**Size**

3.7x2.5 mm

8x5.5 mm

14x10 mm

**Crystal**

Crystal M HF (001)

**Colors**

**Plain Colors**

Aquamarine M HF (202)

Emerald M HF (205)

Graphite M HF (253)

Jet M HF (280)

Sapphire M HF (206)

Scarlet M HF (276)

Vintage Rose M HF (319)

**Crystal Effects**

**Transparent Effects**

Crystal Aurore Boreale M HF (001 AB)

Crystal Golden Shadow M HF (001 GSHA)

**2603** Oval Flat Back

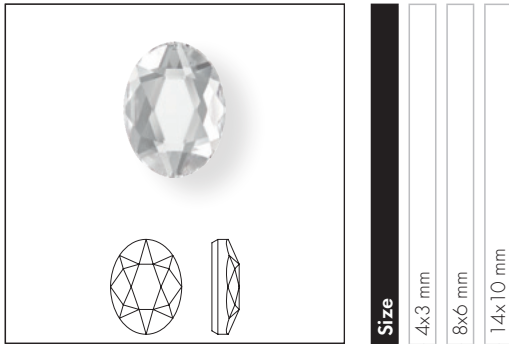

Crystal	4x3 mm	8x6 mm	14x10 mm
Crystal M HF (001)	■	■	■
<b>Colors</b>			
<b>Plain Colors</b>			
Aquamarine M HF (202)	■	■	■
Emerald M HF (205)	■	■	■
Graphite M HF (253)	■	■	■
Jet M HF (280)	■	■	■
Sapphire M HF (206)	■	■	■
Scarlet M HF (276)	■	■	■
Vintage Rose M HF (319)	■	■	■
<b>Crystal Effects</b>			
<b>Transparent Effects</b>			
Crystal Aurore Boreale M HF (001 AB)	■	■	■
Crystal Golden Shadow M HF (001 GSHA)	■	■	■

**2709** Rhombus Flat Back

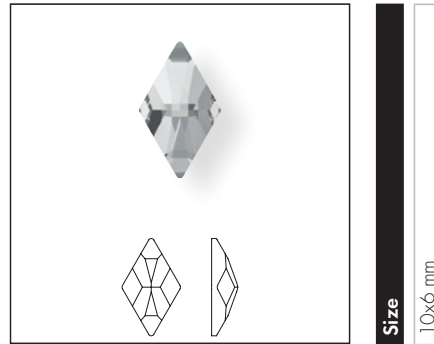

Crystal	10x6 mm
Crystal M HF (001)	■
<b>Crystal Effects</b>	
<b>Transparent Effects</b>	
Crystal Aurore Boreale M HF (001 AB)	■
Crystal Golden Shadow M HF (001 GSHA)	■

### 2711 Triangle Flat Back

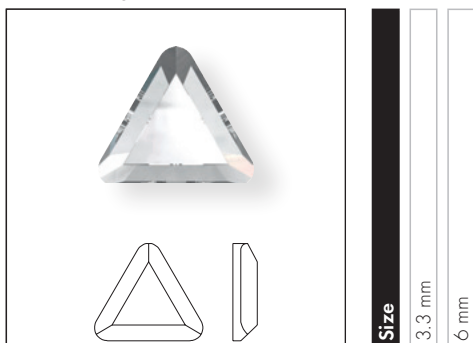

- Crystal**
- Crystal M HF (001)
- Colors**
- Plain Colors**
- Jet M HF (280)
- Crystal Effects**
- Transparent Effects**
- Crystal Aurore Boreale M HF (001 AB)
- Crystal Golden Shadow M HF (001 GSHA)

### 2715 Connector Flat Back

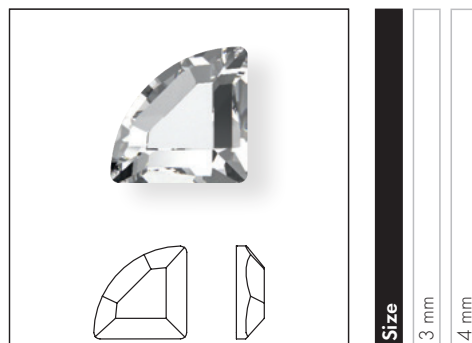

- Crystal**
- Crystal M HF (001)
- Colors**
- Plain Colors**
- Amethyst M HF (204)
- Aquamarine M HF (202)
- Emerald M HF (205)
- Jet M HF (280)
- Light Colorado Topaz M HF (246)
- Scarlet M HF (276)
- Crystal Effects**
- Transparent Effects**
- Crystal Aurore Boreale M HF (001 AB)
- Crystal Golden Shadow M HF (001 GSHA)
- Crystal Silver Night M HF (001 SINI)
- Metallic Effects**
- Crystal Light Chrome M HF (001 LTCH)
- Color Effects**
- Metallic Effects**
- Jet Hematite M HF (280 HEM)

**TRIANGLE FAMILY**

**2738** Triangle Alpha Flat Back

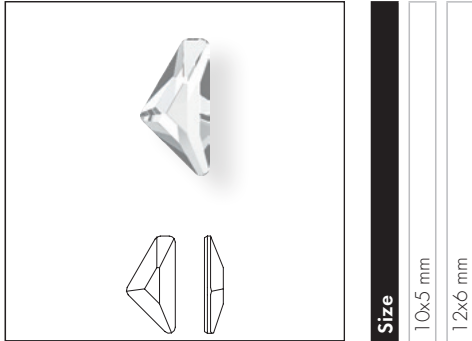

**Size**

10x5 mm

12x6 mm

**Crystal**

Crystal M HF (001)

**Crystal Effects**

**Transparent Effects**

Crystal Aurore Boreale M HF (001 AB)

Crystal Golden Shadow M HF (001 GSHA)

Crystal Silver Night M HF (001 SINI)

**2739** Triangle Beta Flat Back



**Size**

5.8x5.3 mm

7x6.5 mm

**Crystal**

Crystal M HF (001)

**Crystal Effects**

**Transparent Effects**

Crystal Aurore Boreale M HF (001 AB)

Crystal Golden Shadow M HF (001 GSHA)

Crystal Silver Night M HF (001 SINI)

**2740** Triangle Gamma Flat Back

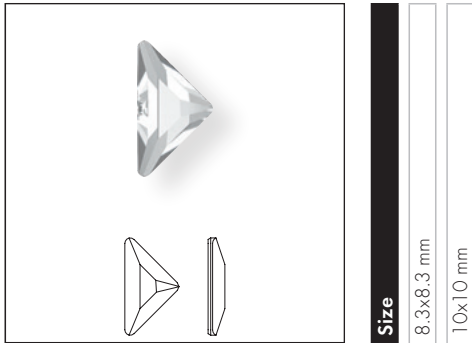

**Size**

8.3x8.3 mm

10x10 mm

**Crystal**

Crystal M HF (001)

**Crystal Effects**

**Transparent Effects**

Crystal Aurore Boreale M HF (001 AB)

Crystal Golden Shadow M HF (001 GSHA)

Crystal Silver Night M HF (001 SINI)

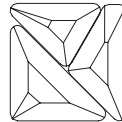

When Alpha, Beta, and Gamma Flat Backs are arranged together, they form a square.



2754 Star Flower Flat Back HF

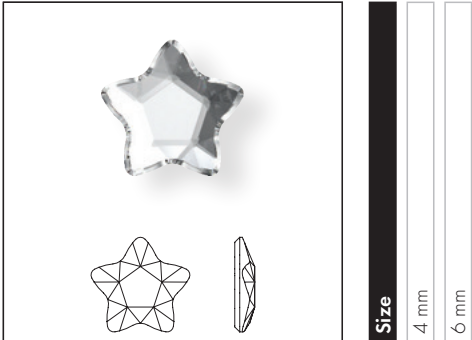

- Crystal**
- Crystal M HF (001)
- Colors**
- Plain Colors**
- Amethyst M HF (204)
- Aquamarine M HF (202)
- Iris M HF (219)
- Jet M HF (280)
- Light Rose M HF (223)
- Light Topaz M HF (226)
- Peridot M HF (214)
- Rose M HF (209)
- Scarlet M HF (276)
- Crystal Effects**
- Transparent Effects**
- Crystal Aurore Boreale M HF (001 AB)
- Crystal Golden Shadow M HF (001 GSHA)

2770 Wing Flat Back

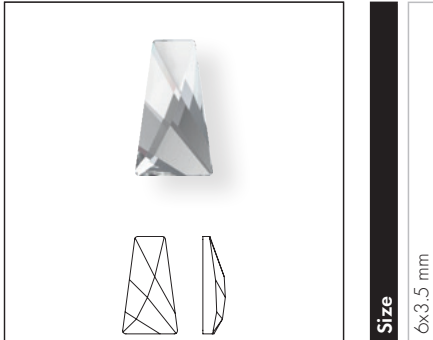

- Crystal**
- Crystal M HF (001)
- Crystal Effects**
- Transparent Effects**
- Crystal Aurore Boreale M HF (001 AB)

## GEOMETRIC FLAT BACKS

**2771** Kite Flat Back

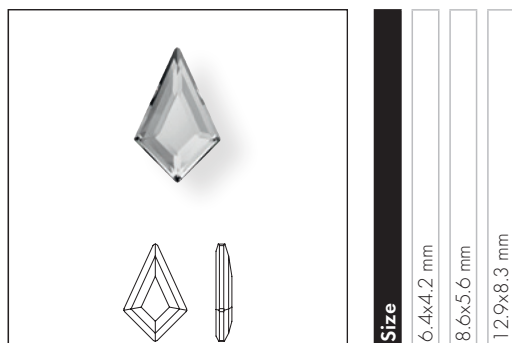

Crystal	6.4x4.2 mm	8.6x5.6 mm	12.9x8.3 mm
Crystal M HF (001)	■	■	■
Colors			
Plain Colors			
Black Diamond M HF (215)	■	■	■
Light Rose M HF (223)	■	■	■
Light Siam M HF (227)	■	■	■
Crystal Effects			
Transparent Effects			
Crystal Aurore Boreale M HF (001 AB)	■	■	■
Crystal Golden Shadow M HF (001 GSHA)	■	■	■
Color Effects			
Metallic Effects			
Jet Hematite M HF (280 HEM)	■	■	■

**2772** Trapeze Flat Back

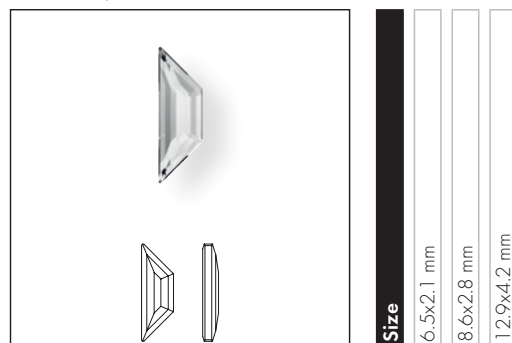

Crystal	6.5x2.1 mm	8.6x2.8 mm	12.9x4.2 mm
Crystal M HF (001)	■	■	■
Colors			
Plain Colors			
Black Diamond M HF (215)	■	■	■
Crystal Effects			
Transparent Effects			
Crystal Aurore Boreale M HF (001 AB)	■	■	■
Crystal Golden Shadow M HF (001 GSHA)	■	■	■
Color Effects			
Metallic Effects			
Jet Hematite M HF (280 HEM)	■	■	■

**2773** Diamond Shape Flat Back

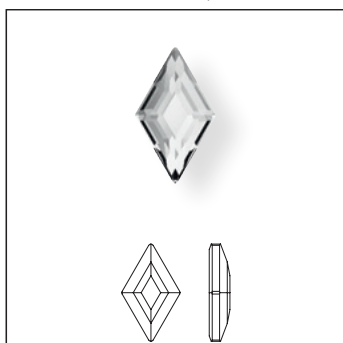

Size
5x3 mm
6.6x3.9 mm
9.9x5.9 mm

- Crystal**
- Crystal M HF (001)
- Colors**
- Plain Colors**
- Black Diamond M HF (215)
- Light Rose M HF (223)
- Light Siam M HF (227)
- Crystal Effects**
- Transparent Effects**
- Crystal Aurore Boreale M HF (001 AB)
- Crystal Golden Shadow M HF (001 GSHA)
- Color Effects**
- Metallic Effects**
- Jet Hematite M HF (280 HEM)

**2774** Elongated Pentagon Flat Back

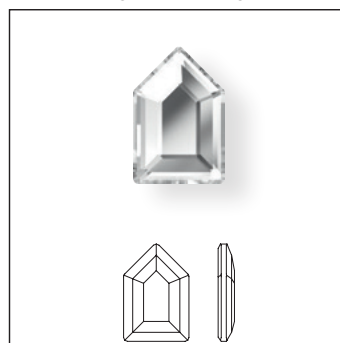

Size
6.3x4.2 mm
8.3x5.6 mm
12.5x8.4 mm

- Crystal**
- Crystal M HF (001)
- Colors**
- Plain Colors**
- Black Diamond M HF (215)
- Light Siam M HF (227)
- Crystal Effects**
- Transparent Effects**
- Crystal Aurore Boreale M HF (001 AB)
- Color Effects**
- Metallic Effects**
- Jet Hematite M HF (280 HEM)

**2775** Concise Pentagon Flat Back

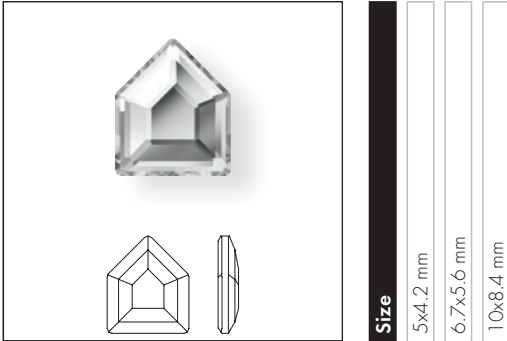

<b>Size</b>	5x4.2 mm	6.7x5.6 mm	10x8.4 mm
-------------	----------	------------	-----------

<b>Crystal</b>			
Crystal M HF (001)	■	■	■
<b>Colors</b>			
<b>Plain Colors</b>			
Black Diamond M HF (215)	■		
Light Siam M HF (227)	■		
<b>Crystal Effects</b>			
<b>Transparent Effects</b>			
Crystal Aurore Boreale M HF (001 AB)	■	■	■
<b>Color Effects</b>			
<b>Metallic Effects</b>			
Jet Hematite M HF (280 HEM)	■		

**2776** Elongated Hexagon Flat Back

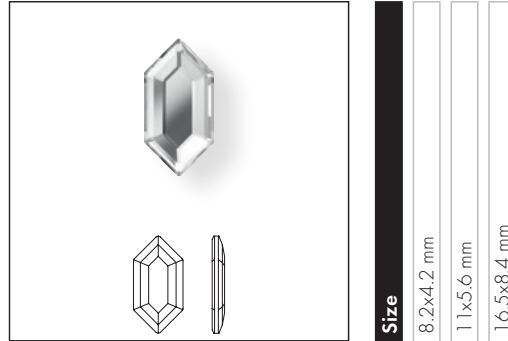

<b>Size</b>	8.2x4.2 mm	11x5.6 mm	16.5x8.4 mm
-------------	------------	-----------	-------------

<b>Crystal</b>			
Crystal M HF HF (001)	■	■	■
<b>Colors</b>			
<b>Plain Colors</b>			
Black Diamond M HF (215)	■		
Light Siam M HF (227)	■		
<b>Crystal Effects</b>			
<b>Transparent Effects</b>			
Crystal Aurore Boreale M HF (001 AB)	■	■	■
<b>Color Effects</b>			
<b>Metallic Effects</b>			
Jet Hematite M HF (280 HEM)	■		

**2777** Concise Hexagon Flat Back

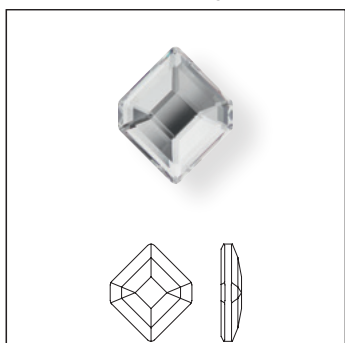

- Crystal**
- Crystal M HF (001)
- Colors**
- Plain Colors**
- Black Diamond M HF (215)
- Light Siam M HF (227)
- Crystal Effects**
- Transparent Effects**
- Crystal Aurore Boreale M HF (001 AB)
- Color Effects**
- Metallic Effects**
- Jet Hematite M HF (280 HEM)

**2788** Wave Flat Back

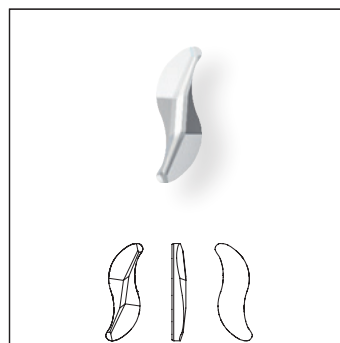

- Crystal**
- Crystal M HF (001)
- Crystal Effects**
- Transparent Effects**
- Crystal Aurore Boreale M HF (001 AB)

03

**2808** Heart Flat Back

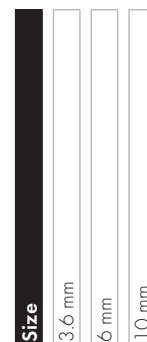
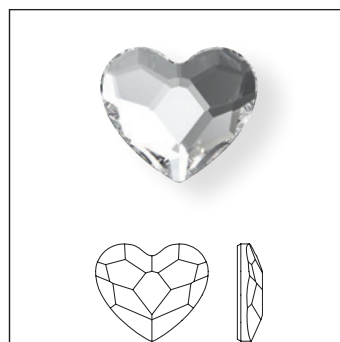

- Crystal**
- Crystal M HF (001)
- Colors**
- Plain Colors**
- Fuchsia M HF (502)
- Jet M HF (280)
- Light Siam M HF (227)
- Crystal Effects**
- Transparent Effects**
- Crystal Aurore Boreale M HF (001 AB)
- Crystal Golden Shadow M HF (001 GSHA)

**2813** Moon Flat Back Hotfix

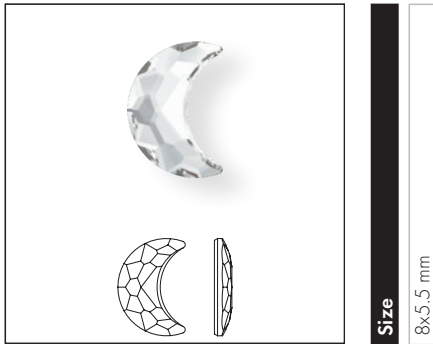

- Crystal**
- Crystal M HF (001)
- Crystal Effects**
- Transparent Effects**
- Crystal Aurore Boreale M HF (001 AB)

**2816** Rivoli Star Flat Back

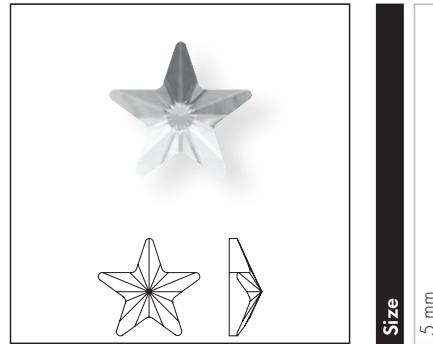

- Crystal**
- Crystal M HF (001)
- Colors**
- Plain Colors**
- Jet M HF (280)
- Crystal Effects**
- Transparent Effects**
- Crystal Aurore Boreale M HF (001 AB)
- Color Effects**
- Metallic Effects**
- Jet Hematite M HF (280 HEM)

# Product Details

Article Size	Packing Unit = Minimum Order Quantity in Pieces	Average Net Weight in Gram per Packing Unit Crystal (001)	Average Gross Weight in Gram per Packing Unit Crystal (001)
<b>1098 A HF</b>			
PP 24 (SS 12)	1440	20.96	31.16
PP 31 (SS 16)	1440	41.13	51.33
SS 20	720	36.58	46.78
<b>2000 A HF</b>			
SS 3	1,440	1.8	12.7
<b>2038 A HF</b>			
SS 5	1,440	4.2	12.1
SS 6	1,440	5.4	17.7
SS 8	1,440	9.96	18.2
SS 10	1,440	15.54	24.3
<b>2038/1</b>			
SS 10	1440	15.7	24.4
<b>2078 A HF</b>			
SS 12	1,440	21.6	30.4
SS 16	1,440	39.1	47.1
SS 20	1,440	72.0	79.6
SS 30	288	34.6	63.0
SS 34	144	26.0	48.6
SS 40	144	43.2	66.9
SS 48	96	61.4	87.4
<b>2078/1 A HF</b>			
SS 16	1,440	39.1	47.1
SS 20	1,440	72.0	79.6
<b>2080/4 HF</b>			
SS 6	1,440	6.5	16.7
SS 10	1,440	17.1	28.3
SS 16	1,440	43.4	54.9
SS 20	1,440	82.9	93.1
SS 34	144	23.2	34.1
<b>2200 M HF</b>			
4x2 mm	720	6.5	18.5
8x4 mm	360	24.8	35.8
<b>2201 M HF</b>			
4x1.8 mm	720	5.7	15.9
8x3.5 mm	144	10.03	31.11
14x6 mm	72	21.67	45.27
<b>2205 M HF</b>			
7.5 mm	288	20.3	30.5
10 mm	144	17.6	42.4
14 mm	72	22.3	45.9
<b>2300 M HF</b>			
8x4.8 mm	360	41.9	51.0
<b>2303 M HF</b>			
8x5 mm	144	15.70	39.60
14x9 mm	72	36.65	60.25

Article Size	Packing Unit = Minimum Order Quantity in Pieces	Average Net Weight in Gram per Packing Unit Crystal (001)	Average Gross Weight in Gram per Packing Unit Crystal (001)
<b>2304 M HF</b>			
10x2.8 mm	180	10.2	20.4
14x3.9 mm	96	13.1	36.3
<b>2400 M HF</b>			
2.2 mm	1,440	9.65	18.5
3 mm	1,440	25.3	36.8
4 mm	720	30.0	41.0
6 mm	144	21.9	32.7
<b>2471 M HF</b>			
5 mm	288	17.3	25.6
7 mm	72	11.9	35.1
10 mm	72	30.2	51.6
<b>2472 M HF</b>			
5 mm	288	17.4	27.6
7 mm	144	20.8	42.8
10 mm	96	34.5	56.5
<b>2510 M HF</b>			
3.7x1.9 mm	720	8.2	10.6
5x2.5 mm	720	23.2	32.3
<b>2555 M HF</b>			
8x2.6 mm	240	18.4	27.5
12x4 mm	144	28.8	33.6
<b>2602 M HF</b>			
3.7x2.5 mm	720	11.5	21.7
8x5.5 mm	144	17.89	41.79
14x10 mm	72	58.61	82.21
<b>2603 M HF</b>			
4x3 mm	288	6.8	17.0
8x6 mm	144	21.7	43.7
14x10 mm	72	50.3	72.3
<b>2709 M HF</b>			
10x6 mm	288	28.9	67.2
<b>2711 M HF</b>			
3.3 mm	720	6.38	15.63
6 mm	360	29.7	40.7
<b>2715 M HF</b>			
3 mm	288	4.0	14.2
4 mm	288	8.2	18.4
<b>2716 M HF</b>			
5 mm	720	35.8	75.1
<b>2738 M HF</b>			
10x5 mm	144	16.7	35.1
12x6 mm	96	20.2	38.3
<b>2739 M HF</b>			
5.8x5.3 mm	216	19.2	41.9
7x6.5 mm	144	22.6	39.8



Article Size	Packing Unit = Minimum Order Quantity in Pieces	Average Net Weight in Gram per Packing Unit Crystal (001)	Average Gross Weight in Gram per Packing Unit Crystal (001)
<b>2740 M HF</b>			
8.3x8.3 mm	216	35.1	54.2
10x10 mm	96	25.1	41.1
<b>2754 M HF</b>			
4 mm	720	13.6	23.8
6 mm	360	20.5	30.7
<b>2770 M HF</b>			
6x3.5 mm	1,440	60.3	70.3
<b>2771 M HF</b>			
6.4x4.2 mm	288	9.04	17.87
8.6x5.6 mm	216	16.84	43.02
12.9x8.3 mm	144	36.29	61.39
<b>2772 M HF</b>			
6.5x2.1 mm	288	6.39	15.17
8.6x2.8 mm	288	16.29	40.71
12.9x4.2 mm	144	25.57	53.86
<b>2773 M HF</b>			
5x3 mm	288	4.83	13.66
6.6x3.9 mm	288	11.23	35.65
9.9x5.9 mm	144	19.30	43.39
<b>2774 M HF</b>			
6.3x4.2 mm	288	18.7	29.6
8.3x5.6 mm	144	19.5	39.4
12.5x8.4 mm	96	39.0	60.3
<b>2775 M HF</b>			
5x4.2 mm	288	13.9	24.7
6.7x5.6 mm	144	15.0	34.3
10x8.4 mm	144	43.6	66.4
<b>2776 M HF</b>			
8.2x4.2 mm	144	11.2	30.1
11x5.6 mm	72	11.3	28.8
16.5x8.4 mm	72	35.6	55.8
<b>2777 M HF</b>			
5x4.2 mm	288	10.4	21.3
6.7x5.6 mm	144	10.5	29.7
10x8.4 mm	144	32.8	52.7
<b>2788 M HF</b>			
8 mm	288	7.5	18.4
<b>2808 M HF</b>			
3.6 mm	720	18.4	20.8
6 mm	288	19.8	28.9
10 mm	144	38.8	55.9
<b>2813 M HF</b>			
8x5.5 mm	144	13.1	37.7
<b>2816 M HF</b>			
5 mm	720	23.6	30.7

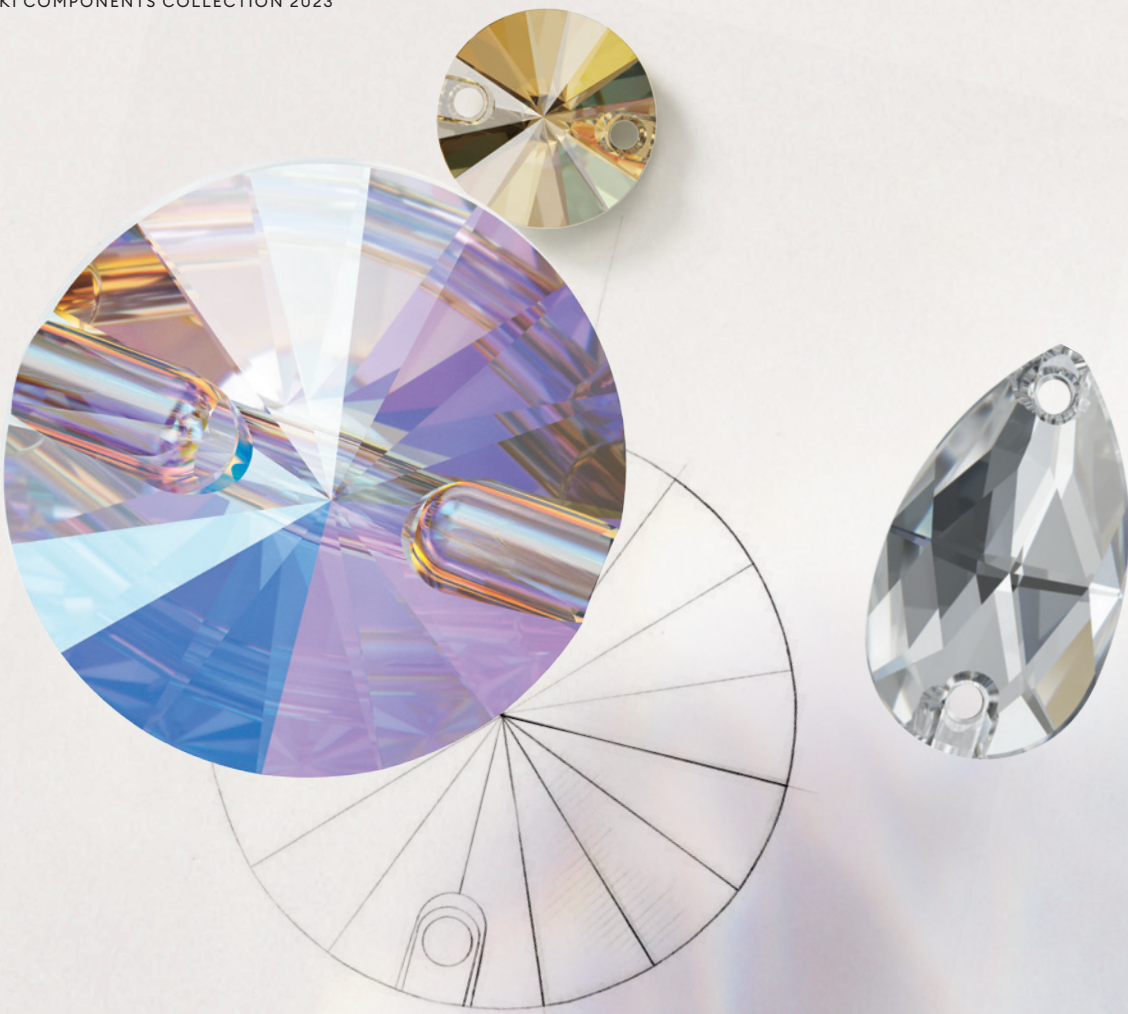







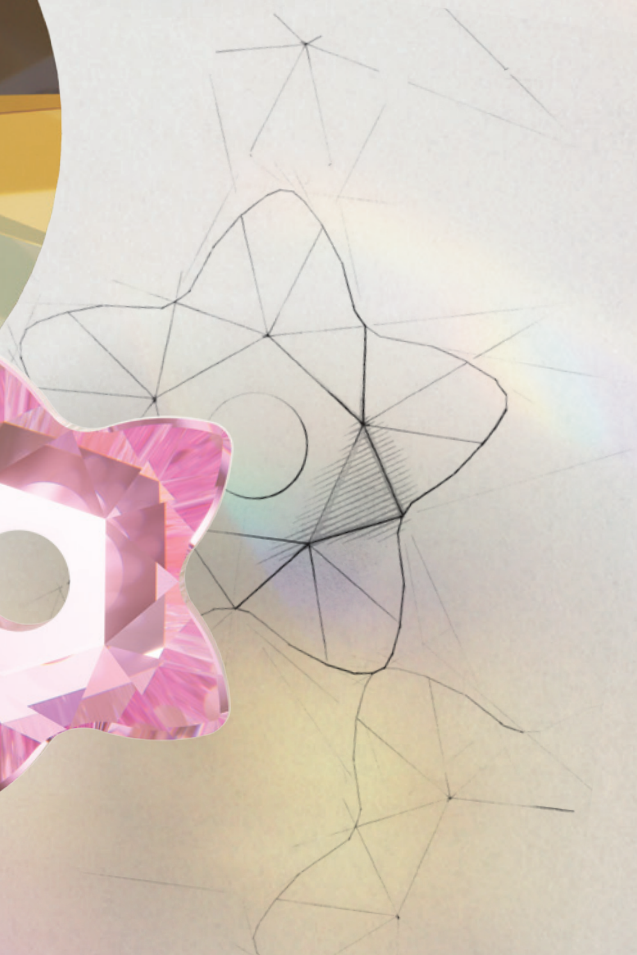
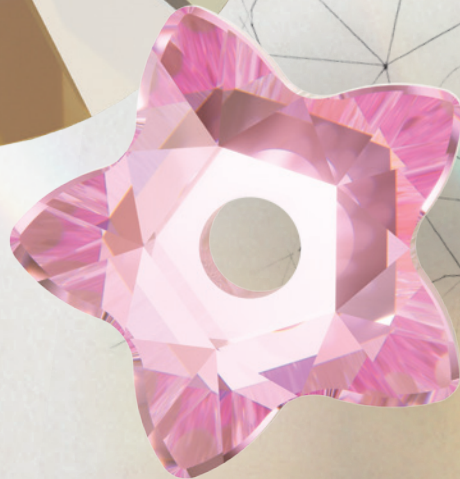









# Sew-on Articles & Crystal Buttons

Sew-On Articles are loose crystals with holes offering convenient sewing options, either sewn by hand, or applied with a standard or industrial embroidery sewing machine. Effortlessly attached to various textiles, they craft beautiful creative embellishment possibilities.









The standout products within this product group are the art. 3188 XIRIUS Lochrose and art. 3288 XIRIUS Sew-on Stones. Completely unique, these items boast innovative multi-layer cutting technology to create the inspiring XIRIUS star design, setting them apart as the most progressive and distinctive designs available in the market.



## Colors

 Crystal 001	 Denim Blue 266
 Light Silk 261	 Peridot 214
 Blush Rose 257	 Fern Green 291
 Light Rose 223	 Emerald 205
 Light Siam 227	 Light Topaz 226
 Scarlet 276	 Light Colorado Topaz 246
 Amethyst 204	 Black Diamond 215
 Aquamarine 202	 Jet 280

## Effects

 Crystal Moonlight 001 MOL
 Crystal Shimmer 001 SHIM
 Crystal Aurore Boreale 001 AB
 Crystal Vitrail Medium 001 VM
 Crystal Golden Shadow 001 GSHA
 Crystal Metallic Sunshine 001 METSH
 Crystal Silver Shade 001 SSHA
 Crystal Silver Night 001 SINI
 Jet Hematite 280 HEM

## Numerical Order

001	Crystal
001 AB	Crystal Aurore Boreale
001 GSHA	Crystal Golden Shadow
001 METSH	Crystal Metallic Sunshine
001 MOL	Crystal Moonlight
001 SHIM	Crystal Shimmer
001 SINI	Crystal Silver Night
001 SSHA	Crystal Silver Shade
001 VM	Crystal Vitrail Medium
202	Aquamarine
204	Amethyst
205	Emerald
214	Peridot
215	Black Diamond
223	Light Rose
226	Light Topaz
227	Light Siam
246	Light Colorado Topaz
257	Blush Rose
261	Light Silk
266	Denim Blue
276	Scarlet
280 HEM	Jet Hematite
280	Jet
291	Fern Green

## Alphabetical Order

Amethyst (204)
Aquamarine (202)
Black Diamond (215)
Blush Rose (257)
Crystal (001)
Crystal Aurore Boreale (001 AB)
Crystal Golden Shadow (001 GSHA)
Crystal Metallic Sunshine (001 METSH)
Crystal Moonlight (001 MOL)
Crystal Shimmer (001 SHIM)
Crystal Silver Night (001 SINI)
Crystal Silver Shade (001 SSHA)
Crystal Vitrail Medium (001 VM)
Denim Blue (266)
Emerald (205)
Fern Green (291)
Jet (280)
Jet Hematite (280 HEM)
Light Colorado Topaz (246)
Light Rose (223)
Light Siam (227)
Light Silk (261)
Light Topaz (226)
Peridot (214)
Scarlet (276)

For details on available colors and effects for each article within the product groups, please see the product matrix of the respective item in the Collection 2023.

The plating resistance of effects is tested according to Swarovski's plating guidelines (SWAROVSKI.COM/S-PROFESSIONALS). Customers are advised to carry out their own tests if their plating parameters diverge from Swarovski plating guidelines.





Colors and effects can appear different when illuminated with different light sources. Swarovski uses standard light source D65 for color decision and comparison. Slight changes in shades are unavoidable. Colors may vary according to cut and foiling.

The composition of Advanced Crystal is compliant with regulatory industry norms and laws regarding the restriction or prohibition of certain substances in the most relevant segments of our customers. Please note that the compliance of the colors Light Siam and Siam varies according to certain industry regulations. Those regulations are indicated with \* in the compliance overview. Indian Siam, Ruby and Scarlet (option to Lt. Siam) conform to all CLEAR-lists. For further information please visit [swarovski.com/s-professionals](http://swarovski.com/s-professionals)

© 2023 D. Swarovski Distribution GmbH

# Sew-on Articles

# Summary

1	2		1	2	
		<b>3188</b> 3, 4, 5, 6, 7, 8 mm			<b>3288</b> 8, 10, 12 mm
		<b>3200</b> 8, 10, 12, 14, 16, 18 mm			<b>3700</b> 6, 8, 10, 12, 14 mm
		<b>3210</b> 10x7, 16x11, 24x17 mm			<b>3754</b> 5, 7 mm
		<b>3223</b> 12x6, 18x9, 29x14.5 mm			
		<b>3230</b> 12x7, 18x10.5, 23x13.8, 28x17, 34x20.4 mm			
		<b>3240</b> 16, 22 mm			
		<b>3252</b> 14x10, 20x14, 28x20 mm			
		<b>3255</b> 18x6, 26x8.5 mm			
		<b>3256</b> 14x8.5, 19x11.5, 27x16 mm			
		<b>3265</b> 20x16, 26x21 mm			
		<b>3270</b> 16, 22 mm			

1 Top view 2 Side view

3188 XIRIUS Lochrose

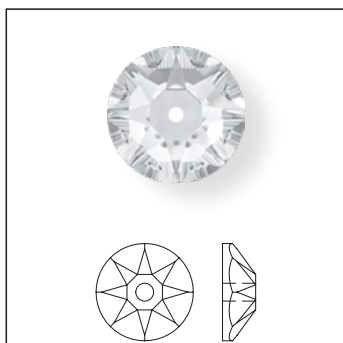

Size	3 mm	4 mm	5 mm	6 mm	7 mm	8 mm
------	------	------	------	------	------	------

**Crystal**

- Crystal (001)
- Crystal F (001)

**Colors**

**Plain Colors**

- Aquamarine F (202)
- Black Diamond F (215)
- Blush Rose F (257)
- Denim Blue F (266)
- Emerald F (205)
- Jet (280)
- Light Colorado Topaz F (246)
- Light Rose F (223)
- Light Siam F (227)
- Light Silk F (261)
- Scarlet F (276)

**Crystal Effects**

**Transparent Effects**

- Crystal Aurore Boreale F (001 AB)
- Crystal Golden Shadow F (001 GSHA)
- Crystal Moonlight F (001 MOL)
- Crystal Silver Night (001 SINI)
- Crystal Silver Shade F (001 SSHA)

**Metallic Effects**

- Crystal Metallic Sunshine F (001 METSH)

**Color Effects**

**Metallic Effects**

- Jet Hematiite (280 HEM)

Crystal (001)	■	■	■			
Crystal F (001)	■	■	■	■	■	■
Aquamarine F (202)	■	■	■			
Black Diamond F (215)	■	■	■			
Blush Rose F (257)	■	■	■			
Denim Blue F (266)	■	■	■			
Emerald F (205)	■	■	■			
Jet (280)	■	■	■	■	■	■
Light Colorado Topaz F (246)	■	■	■			
Light Rose F (223)	■	■	■			
Light Siam F (227)	■	■	■			
Light Silk F (261)	■	■	■			
Scarlet F (276)	■	■	■			
Crystal Aurore Boreale F (001 AB)	■	■	■	■	■	■
Crystal Golden Shadow F (001 GSHA)	■	■	■	■	■	■
Crystal Moonlight F (001 MOL)	■	■	■			
Crystal Silver Night (001 SINI)		■	■			
Crystal Silver Shade F (001 SSHA)	■	■	■			
Crystal Metallic Sunshine F (001 METSH)	■	■	■			
Jet Hematiite (280 HEM)	■	■	■			

### 3200 Rivoli Sew-on Stone

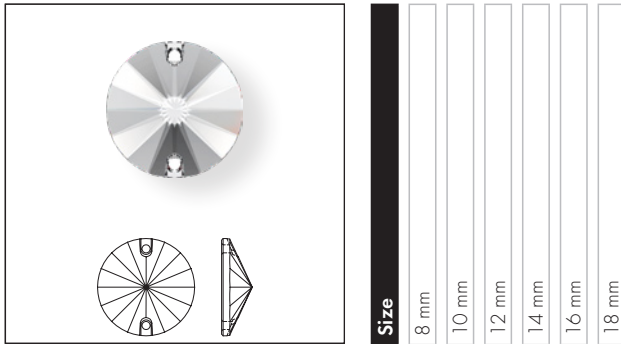

**Size**  
8 mm  
10 mm  
12 mm  
14 mm  
16 mm  
18 mm

Crystal	8 mm	10 mm	12 mm	14 mm	16 mm	18 mm
Crystal F (001)	■	■	■	■	■	■
<b>Colors</b>						
<b>Plain Colors</b>						
Aquamarine F (202)	■	■	■	■		
Black Diamond F (215)	■	■	■	■		
Emerald F (205)	■	■	■	■		
Jet (280)	■	■	■	■		
Light Colorado Topaz F (246)	■	■	■	■		
Light Rose F (223)	■	■	■	■		
Light Siam F (227)	■	■	■	■		
Scarlet F (276)	■	■	■	■		
<b>Crystal Effects</b>						
<b>Transparent Effects</b>						
Crystal Aurore Boreale F (001 AB)	■	■	■	■	■	■
Crystal Golden Shadow F (001 GSHA)	■	■	■	■		
<b>Metallic Effects</b>						
Crystal Metallic Sunshine F (001 METSH)	■	■	■	■		
<b>Color Effects</b>						
<b>Metallic Effects</b>						
Jet Hematite (280 HEM)	■	■	■	■		

### 3210 Oval Sew-on Stone

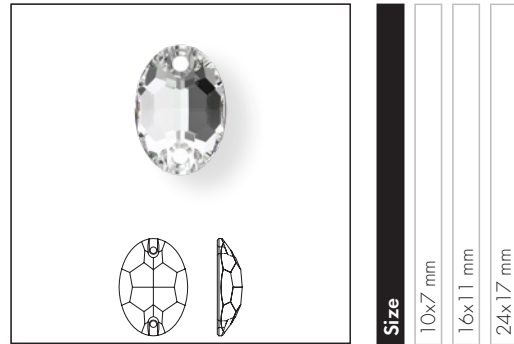

**Size**  
10x7 mm  
16x11 mm  
24x17 mm

Crystal	10x7 mm	16x11 mm	24x17 mm
Crystal F (001)	■	■	■
<b>Colors</b>			
<b>Plain Colors</b>			
Jet (280)	■	■	■
<b>Crystal Effects</b>			
<b>Transparent Effects</b>			
Crystal Aurore Boreale F (001 AB)	■	■	■



**3223** Navette Sew-on Stone



Size
12x6 mm
18x9 mm
29x14.5 mm

Crystal	12x6 mm	18x9 mm	29x14.5 mm
Crystal F (001)	■	■	■
Colors			
Plain Colors			
Aquamarine F (202)	■	■	
Black Diamond F (215)	■	■	
Emerald F (205)	■	■	
Jet (280)	■	■	■
Light Colorado Topaz F (246)	■	■	
Crystal Effects			
Transparent Effects			
Crystal Aurore Boreale F (001 AB)	■	■	■
Crystal Golden Shadow F (001 GSHA)	■	■	■

**3230** Drop Sew-on (Size Extension)



Size
12x7 mm
18x10.5 mm
23x13.8 mm
28x17 mm
34x20.4 mm

Crystal	12x7 mm	18x10.5 mm	23x13.8 mm	28x17 mm	34x20.4 mm
Crystal F (001)	■	■	■	■	■
Colors					
Plain Colors					
Aquamarine F (202)	■	■	■	■	
Black Diamond F (215)	■	■	■	■	
Emerald F (205)	■	■	■	■	
Jet (280)	■	■	■	■	■
Light Colorado Topaz F (246)	■	■	■	■	
Light Rose F (223)	■	■	■	■	
Scarlet F (276)	■	■	■	■	
Crystal Effects					
Transparent Effects					
Crystal Aurore Boreale F (001 AB)	■	■	■	■	■
Crystal Golden Shadow F (001 GSHA)	■	■	■	■	■
Crystal Silver Night (001 SINI)	■	■	■	■	■

### 3240 Square Sew-on Stone

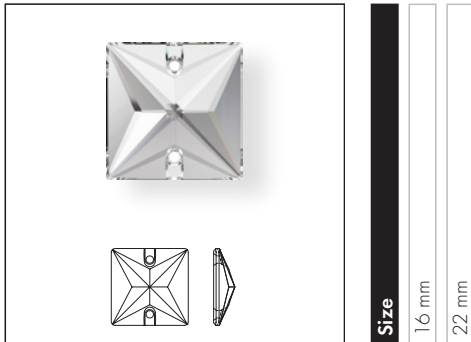

**Size**  
16 mm  
22 mm

- Crystal**
- Crystal F (001)
- Colors**
- Plain Colors
- Jet (280)
- Crystal Effects**
- Transparent Effects
- Crystal Aurore Boreale F (001 AB)

### 3252 Emerald Cut Sew-on Stone

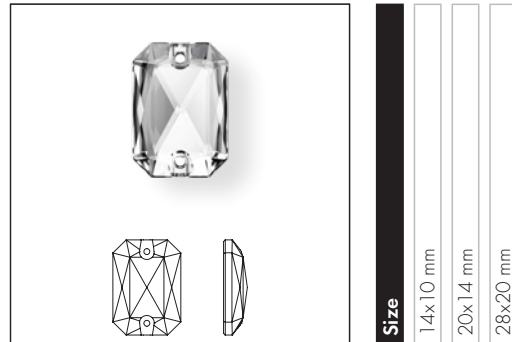

**Size**  
14x10 mm  
20x14 mm  
28x20 mm

- Crystal**
- Crystal F (001)
- Colors**
- Plain Colors
- Jet (280)
- Crystal Effects**
- Transparent Effects
- Crystal Aurore Boreale F (001 AB)

**3255 Cosmic Baguette Sew-on Stone**

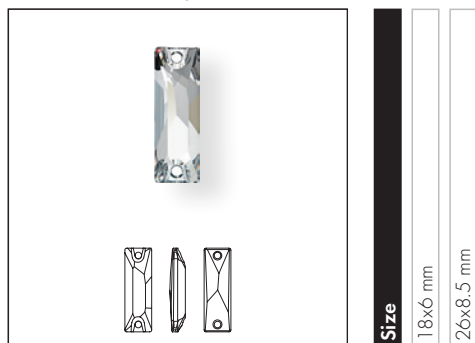

**Size**

18x6 mm

26x8.5 mm

**Crystal**

Crystal F (001)

**Colors**

**Plain Colors**

Jet (280)

**Crystal Effects**

**Transparent Effects**

Crystal Aurore Boreale F (001 AB)

**3256 Galactic Sew-on Stone**



**Size**

14x8.5 mm

19x11.5 mm

27x16 mm

**Crystal**

Crystal F (001)

**Colors**

**Plain Colors**

Jet (280)

**Crystal Effects**

**Transparent Effects**

Crystal Aurore Boreale F (001 AB)

**3265** Cosmic Sew-on Stone



**Size**

20x16 mm

26x21 mm

**Crystal**

Crystal F (001)

**Colors**

**Plain Colors**

Jet (280)

**Crystal Effects**

**Transparent Effects**

Crystal Aurore Boreale F (001 AB)

**3270** Triangle Sew-on Stone

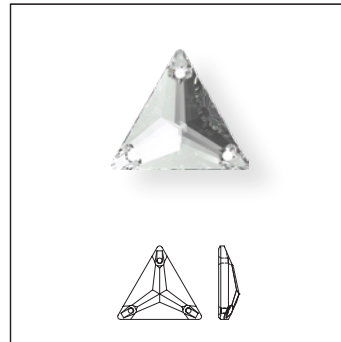

**Size**

16 mm

22 mm

**Crystal**

Crystal F (001)

**Colors**

**Plain Colors**

Jet (280)

**Crystal Effects**

**Transparent Effects**

Crystal Aurore Boreale F (001 AB)

**3288 XIRIUS Sew-on Stone**

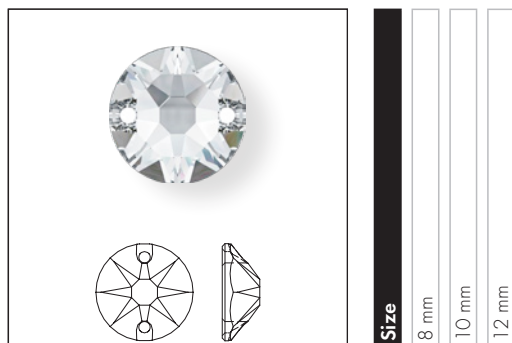

**Size**  
8 mm  
10 mm  
12 mm

**Crystal**

Crystal F (001)

**Colors**

**Plain Colors**

- Aquamarine F (202)
- Black Diamond F (215)
- Blush Rose F (257)
- Denim Blue F (266)
- Emerald F (205)
- Jet (280)
- Light Colorado Topaz F (246)
- Light Rose F (223)
- Light Siam F (227)
- Scarlet F (276)

**Crystal Effects**

**Transparent Effects**

- Crystal Aurore Boreale F (001 AB)
- Crystal Golden Shadow F (001 GSHA)
- Crystal Moonlight F (001 MOL)
- Crystal Silver Night (001 SINI)
- Crystal Silver Shade F (001 SSHA)

**Metallic Effects**

- Crystal Metallic Sunshine F (001 METSH)

**Color Effects**

**Metallic Effects**

- Jet Hematite (280 HEM)

**3700 Marguerite Lochrose**

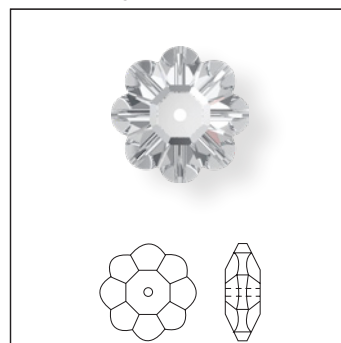

**Size**  
6 mm  
8 mm  
10 mm  
12 mm  
14 mm

**Crystal**

Crystal (001)

Crystal F (001)

**Colors**

**Plain Colors**

- Fern Green (291)
- Jet (280)
- Light Siam (227)
- Peridot (214)

**Crystal Effects**

**Transparent Effects**

- Crystal Aurore Boreale (001 AB)
- Crystal Golden Shadow (001 GSHA)
- Crystal Shimmer (001 SHIM)
- Crystal Vitrail Medium (001 VM)

**3754** Star Flower Sew-on Stone

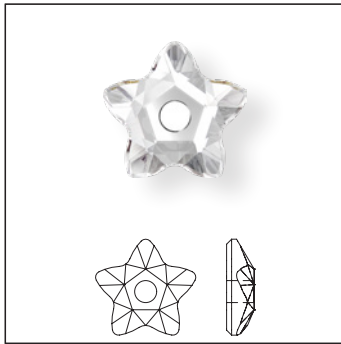

Size	5 mm	7 mm

Crystal	5 mm	7 mm
Crystal F (001)	■	■
Colors		
Plain Colors		
Amethyst F (204)	■	■
Aquamarine F (202)	■	■
Emerald F (205)	■	■
Iris F (219)	■	■
Jet (280)	■	■
Light Rose F (223)	■	■
Light Topaz F (226)	■	■
Scarlet F (276)	■	■
Crystal Effects		
Transparent Effects		
Crystal Aurore Boreale F (001 AB)	■	■
Crystal Golden Shadow F (001 GSHA)	■	■

# Product Details

Article Size	Packing Unit = Minimum Order Quantity in Pieces	Average Net Weight in Gram per Packing Unit Crystal (001)	Average Gross Weight in Gram per Packing Unit Crystal (001)
<b>3188</b>			
3 mm	1,440	21.5	30.0
4 mm	1,440	47.6	56.0
5 mm	720	43.2	51.7
6 mm	360	35.7	44.1
7 mm	144	22.2	30.7
8 mm	144	33.2	41.7
<b>3200</b>			
8 mm	144	34.0	53.0
10 mm	72	26.1	44.6
12 mm	72	54.9	74.0
14 mm	72	77.2	100.7
16 mm	72	115.8	139.4
18 mm	48	117.2	199.5
<b>3210</b>			
10x7 mm	72	18.1	37.9
16x11 mm	72	66.3	86.3
24x17 mm	24	72.5	97.9
<b>3223</b>			
12x6 mm	48	13.1	34.2
18x9 mm	36	27.7	45.1
29x14.5 mm	24	74.28	101.3
<b>3230</b>			
12x7 mm	96	29.7	47.0
18x10.5 mm	72	70.5	90.7
23x13.8 mm	36	67	95
28x17 mm	24	72.1	97.5
34x20.4 mm	16	96	122
<b>3240</b>			
16 mm	72	108.5	132.1
22 mm	24	88.0	139.6
<b>3252</b>			
14x10 mm	36	29.59	50.19
20x14 mm	15	35.55	60.28
28x20 mm	10	67.65	88.78
<b>3255</b>			
18x6 mm	96	64.3	87.1
26x8.5 mm	48	87.6	125.6
<b>3256</b>			
14x8.5 mm	96	48.2	67.5
19x11.5 mm	96	104.5	140.1
27x16 mm	30	95.4	128.9
<b>3265</b>			
20x16 mm	72	113.5	138.4
26x21 mm	20	59.8	85.0
<b>3270</b>			
16 mm	72	96.4	120.0
22 mm	24	72.3	117.4

<b>Article Size</b>	<b>Packing Unit = Minimum Order Quantity in Pieces</b>	<b>Average Net Weight in Gram per Packing Unit Crystal (001)</b>	<b>Average Gross Weight in Gram per Packing Unit Crystal (001)</b>
<b>3288</b>			
8 mm	144	51.0	61.9
10 mm	72	53.9	80.3
12 mm	72	69.8	96.5
<b>3700</b>			
6 mm	720	50.6	61.4
8 mm	288	62.2	88.4
10 mm	288	114.5	141.0
12 mm	144	105.4	128.5
14 mm	144	170.5	197.2
<b>3754</b>			
5 mm	720	28.4	38.6
7 mm	144	14.6	24.8



# Crystal Buttons

# Summary

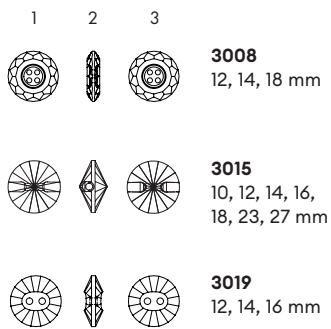

**3008** Classic Crystal Button (4 holes)

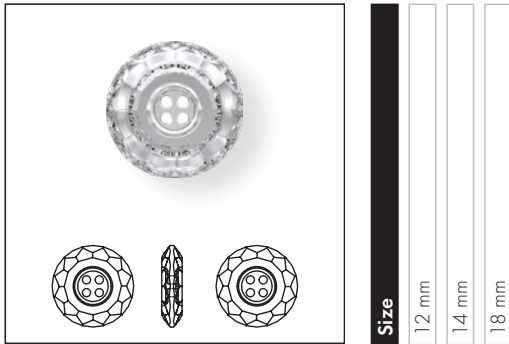

Crystal	12 mm	14 mm	18 mm
Crystal F (001)	■	■	■
Colors			
Plain Colors			
Jet (280)	■	■	■

**3015** Classic Rivoli Crystal Button

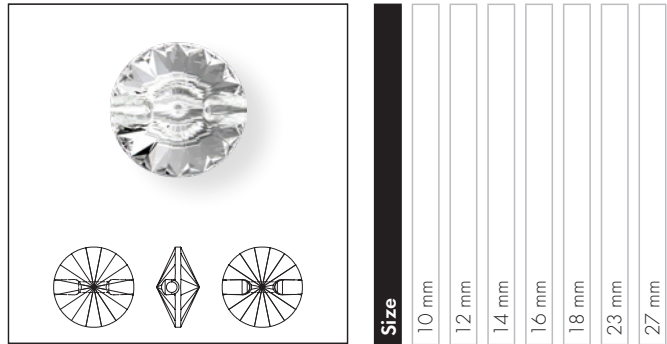

Crystal	10 mm	12 mm	14 mm	16 mm	18 mm	23 mm	27 mm
Crystal F (001)	■	■	■	■	■	■	■
Colors							
Plain Colors							
Black Diamond F (215)	■	■					
Jet (280)	■	■	■	■	■	■	■
Crystal Effects							
Transparent Effects							
Crystal Aurore Boreale F (001 AB)	■	■					
Crystal Golden Shadow F (001 GSHA)	■	■					

**3019** Rivoli Crystal Button (2 holes)

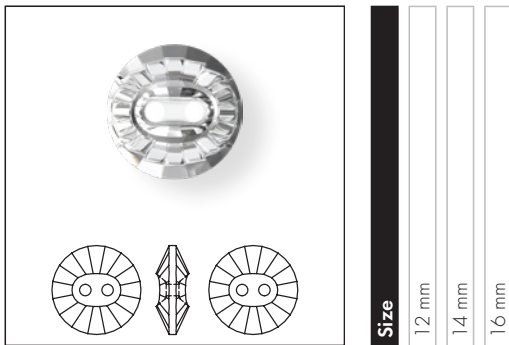

Crystal	12 mm	14 mm	16 mm
Crystal F (001)	■	■	■
Colors			
Plain Colors			
Jet (280)	■	■	■

# Product Details

Article Size	Packing Unit = Minimum Order Quantity in Pieces	Average Net Weight in Gram per Packing Unit Crystal (001)	Average Gross Weight in Gram per Packing Unit Crystal (001)
<b>3008</b>			
12 mm	48	29.9	50.8
14 mm	36	32.0	50.5
18 mm	24	52.3	72.0
<b>3015</b>			
10 mm	72	35.4	54.0
12 mm	48	41.4	59.9
14 mm	36	42.5	59.8
16 mm	24	47.6	64.9
18 mm	24	62.1	79.1
23 mm	8	42.9	64.9
27 mm	8	67.6	89.6
<b>3019</b>			
12 mm	48	31.2	51.3
14 mm	36	41.4	59.3
16 mm	24	39.8	62.5



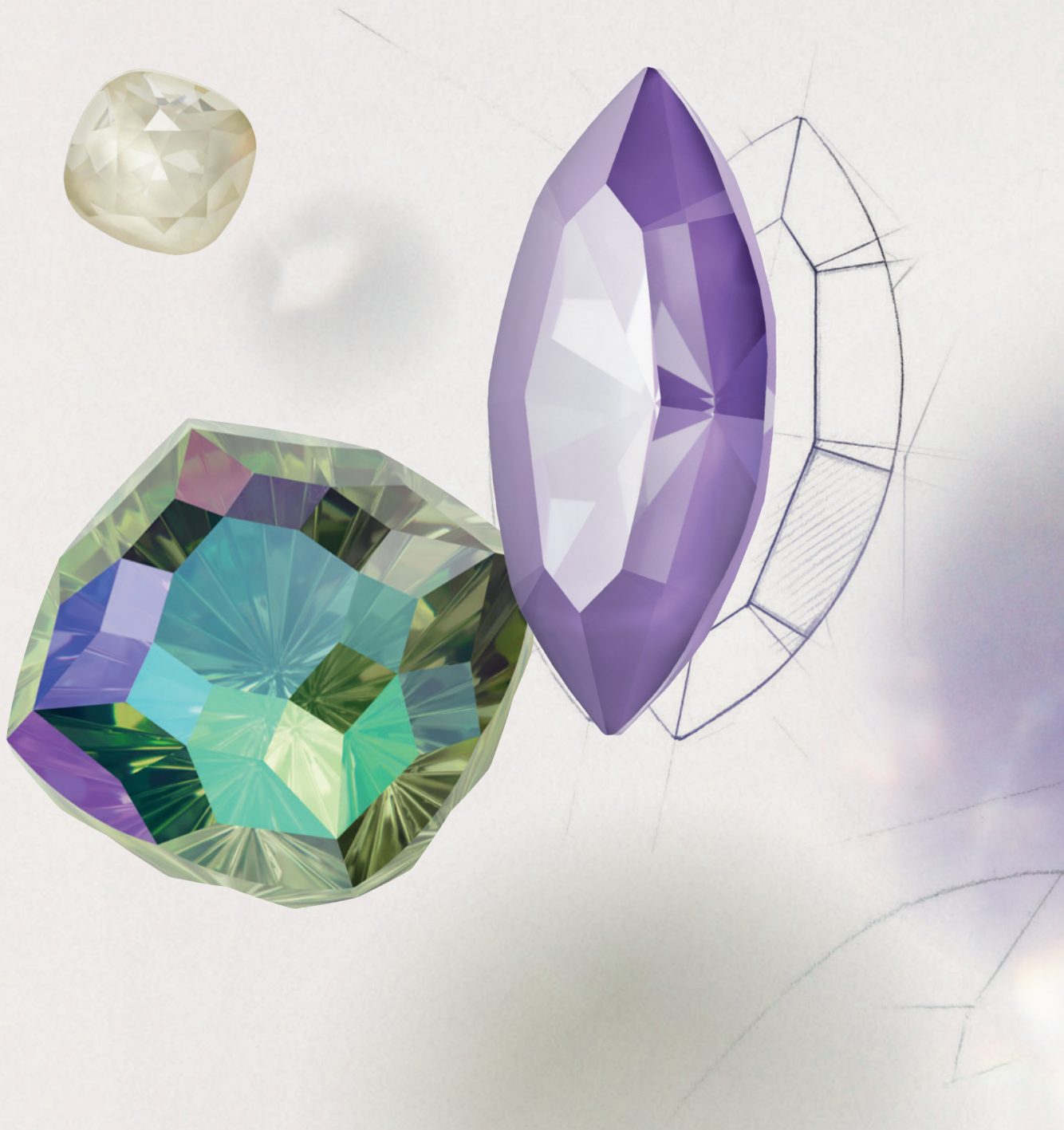

# Fancy Stones

Fancy Stones are available in a wide range of inspiring shapes from traditional gemstone-inspired cuts to progressive, contemporary stones. Available in a captivating assortment of various sizes and colors, they offer endless creative possibility. Showing either a faceted or non-flat reverse side, Fancy Stones can be glued into pre-cast cavities or used in metal settings. With their precision-cut facets, Fancy Stones deliver unparalleled brilliance to infuse designs with a uniquely captivating shine.

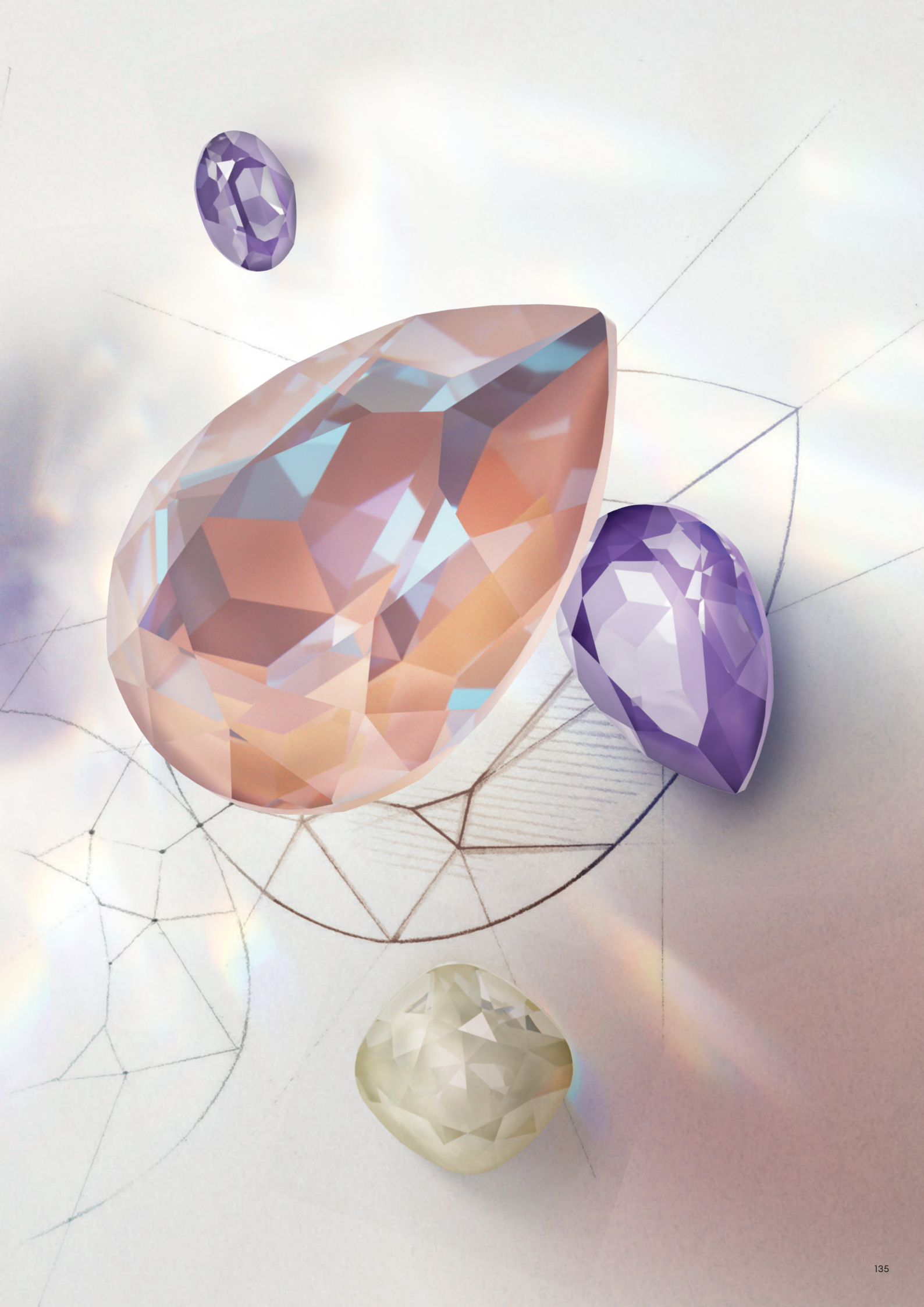











































## Colors & Effects

OPEN TO SEE COLORS & EFFECTS

## Colors







- |   |   |
|---|---|
|  Crystal<br>001           |  Erinite<br>360              |
|  White Opal<br>234        |  Chrysolite<br>238           |
|  Light Silk<br>261        |  Peridot<br>214              |
|  Rosaline<br>508          |  Citrus Green<br>337         |
|  Rose Water Opal<br>395   |  Emerald<br>205              |
|  Vintage Rose<br>319      |  Jonquil<br>213              |
|  Light Rose<br>223        |  Light Topaz<br>226          |
|  Rose Peach<br>262        |  Golden Topaz<br>1003        |
|  Rose<br>209              |  Light Colorado Topaz<br>246 |
|  Fuchsia<br>502           |  Light Amber<br>1002         |
|  Light Siam<br>227       |  Smoked Amber<br>1001       |
|  Scarlet<br>276         |  Black Diamond<br>215      |
|  Siam<br>208            |  Jet<br>280                |
|  Amethyst<br>204        |   |
|  Iris<br>219            |   |
|  Light Amethyst<br>212  |   |
|  Violet<br>371          |   |
|  Tanzanite<br>539       |   |
|  Light Azore<br>361     |   |
|  Aquamarine<br>202      |   |
|  Light Sapphire<br>211  |   |
|  Sapphire<br>206        |   |
|  Montana<br>207         |   |
|  Denim Blue<br>266      |   |
|  Light Turquoise<br>263 |   |

## Effects



- |   |
|---|
|  Crystal Moonlight<br>001 MOL        |
|  Crystal Aurore Boreale<br>001 AB    |
|  Crystal Vitrail Light<br>001 VL     |
|  Crystal Paradise Shine<br>001 PARSH |
|  Crystal Vitrail Medium<br>001 VM    |
|  Crystal Volcano<br>001 VOL          |
|  Crystal Bermuda Blue<br>001 BBL     |
|  Crystal Blue Shade<br>001 BLSH      |
|  Crystal Golden Shadow<br>001 GSHA   |
|  Crystal Silver Shade<br>001 SSHA    |
|  Crystal Silver Night<br>001 SINI    |

## Crystal Lacquer<sup>PRO</sup> Effects





### Crystal Lacquer<sup>PRO</sup> DeLite Effects

- |   |
|---|
|  Crystal Ivory Cream DeLite<br>001 L106D   |
|  Crystal Dusty Pink DeLite<br>001 L149D    |
|  Crystal Orange Glow DeLite<br>001 L146D   |
|  Crystal Lotus Pink DeLite<br>001 L145D    |
|  Crystal Royal Red DeLite<br>001 L107D     |
|  Crystal Lavender DeLite<br>001 L144D      |
|  Crystal Ocean DeLite<br>001 L143D         |
|  Crystal Royal Blue DeLite<br>001 L110D    |
|  Crystal Laguna DeLite<br>001 L142D        |
|  Crystal Silky Sage DeLite<br>001 L147D   |
|  Crystal Serene Gray DeLite<br>001 L150D |

### Crystal Lacquer<sup>PRO</sup> Ignite Effects

- |  |
|--|
|  Crystal Linen Ignite<br>001 L164I    |
|  Crystal Flamingo Ignite<br>001 L162I |
|  Crystal Orange Ignite<br>001 L159I   |
|  Crystal Maroon Ignite<br>001 L160I   |
|  Crystal Purple Ignite<br>001 L161I   |
|  Crystal Sky Ignite<br>001 L163I      |

## Ignite Effects

- |  |
|--|
|  Crystal Ignite<br>001 IGNIT              |
|  Light Rose Ignite<br>223 IGNIT           |
|  Scarlet Ignite<br>276 IGNIT              |
|  Amethyst Ignite<br>204 IGNIT             |
|  Aquamarine Ignite<br>202 IGNIT           |
|  Emerald Ignite<br>205 IGNIT              |
|  Light Colorado Topaz Ignite<br>246 IGNIT |

## Shimmer Effects

- |   |
|---|
|  Light Topaz Shimmer<br>226 SHIM |
|---|

## Numerical Order

001	Crystal	001 SINI	Crystal Silver Night	227	Light Siam
001 AB	Crystal Aurore Boreale	001 SSHA	Crystal Silver Shade	234	White Opal
001 BBL	Crystal Bermuda Blue	001 VL	Crystal Vitrail Light	238	Chrysolite
001 BLSH	Crystal Blue Shade	001 VM	Crystal Vitrail Medium	246 IGNIT	Light Colorado Topaz Ignite
001 GSHA	Crystal Golden Shadow	001 VOL	Crystal Volcano	246	Light Colorado Topaz
001 IGNIT	Crystal Ignite	202 IGNIT	Aquamarine Ignite	261	Light Silk
001 LI06D	Crystal Ivory Cream DeLite	202	Aquamarine	262	Rose Peach
001 LI07D	Crystal Royal Red DeLite	204 IGNIT	Amethyst Ignite	263	Light Turquoise
001 LI10D	Crystal Royal Blue DeLite	204	Amethyst	266	Denim Blue
001 LI42D	Crystal Laguna DeLite	205 IGNIT	Emerald Ignite	276 IGNIT	Scarlet Ignite
001 LI43D	Crystal Ocean DeLite	205	Emerald	276	Scarlet
001 LI44D	Crystal Lavender DeLite	206	Sapphire	280	Jet
001 LI45D	Crystal Lotus Pink DeLite	207	Montana	319	Vintage Rose
001 LI46D	Crystal Orange Glow DeLite	208	Siam	337	Citrus Green
001 LI47D	Crystal Silky Sage DeLite	209	Rose	360	Erinite
001 LI49D	Crystal Dusty Pink DeLite	211	Light Sapphire	361	Light Azore
001 LI50D	Crystal Serene Gray DeLite	212	Light Amethyst	371	Violet
001 LI59I	Crystal Orange Ignite	213	Jonquil	395	Rose Water Opal
001 LI60I	Crystal Maroon Ignite	214	Peridot	502	Fuchsia
001 LI61I	Crystal Purple Ignite	215	Black Diamond	508	Rosaline
001 LI62I	Crystal Flamingo Ignite	219	Iris	539	Tanzanite
001 LI63I	Crystal Sky Ignite	223 IGNIT	Light Rose Ignite	1001	Smoked Amber
001 LI64I	Crystal Linen Ignite	223	Light Rose	1002	Light Amber
001 MOL	Crystal Moonlight	226 SHIM	Light Topaz Shimmer	1003	Golden Topaz
001 PARSH	Crystal Paradise Shine	226	Light Topaz		

## Alphabetical Order

Amethyst (204)	Crystal Paradise Shine (001 PARSH)	Light Colorado Topaz Ignite (246 IGNIT)
Amethyst Ignite (204 IGNIT)	Crystal Purple Ignite (001 LI61I)	Light Rose (223)
Aquamarine (202)	Crystal Royal Blue DeLite (001 LI10D)	Light Rose Ignite (223 IGNIT)
Aquamarine Ignite (202 IGNIT)	Crystal Royal Red DeLite (001 LI07D)	Light Sapphire (211)
Black Diamond (215)	Crystal Serene Gray DeLite (001 LI50D)	Light Siam (227)
Chrysolite (238)	Crystal Silky Sage DeLite (001 LI47D)	Light Silk (261)
Citrus Green (337)	Crystal Silver Night (001 SINI)	Light Topaz (226)
Crystal (001)	Crystal Silver Shade (001 SSHA)	Light Topaz Shimmer (226 SHIM)
Crystal Aurore Boreale (001 AB)	Crystal Sky Ignite (001 LI63I)	Light Turquoise (263)
Crystal Bermuda Blue (001 BBL)	Crystal Vitrail Light (001 VL)	Montana (207)
Crystal Blue Shade (001 BLSH)	Crystal Vitrail Medium (001 VM)	Peridot (214)
Crystal Dusty Pink DeLite (001 LI49D)	Crystal Volcano (001 VOL)	Rosaline (508)
Crystal Flamingo Ignite (001 LI62I)	Denim Blue (266)	Rose (209)
Crystal Golden Shadow (001 GSHA)	Emerald (205)	Rose Peach (262)
Crystal Ignite (001 IGNIT)	Emerald Ignite (205 IGNIT)	Rose Water Opal (395)
Crystal Ivory Cream DeLite (001 LI06D)	Erinite (360)	Sapphire (206)
Crystal Laguna DeLite (001 LI42D)	Fuchsia (502)	Scarlet (276)
Crystal Lavender DeLite (001 LI44D)	Golden Topaz (1003)	Scarlet Ignite (276 IGNIT)
Crystal Linen Ignite (001 LI64I)	Iris (219)	Siam (208)
Crystal Lotus Pink DeLite (001 LI45D)	Jet (280)	Smoked Amber (1001)
Crystal Maroon Ignite (001 LI60I)	Jonquil (213)	Tanzanite (539)
Crystal Moonlight (001 MOL)	Light Amber (1002)	Vintage Rose (319)
Crystal Ocean DeLite (001 LI43D)	Light Amethyst (212)	Violet (371)
Crystal Orange Glow DeLite (001 LI46D)	Light Azore (361)	White Opal (234)
Crystal Orange Ignite (001 LI59I)	Light Colorado Topaz (246)	

For details on available colors and effects for each article within the product groups, please see the product matrix of the respective item in the Collection 2023.

The plating resistance of effects is tested according to Swarovski's plating guidelines (SWAROVSKI.COM/S-PROFESSIONALS). Customers are advised to carry out their own tests if their plating parameters diverge from Swarovski plating guidelines.

Colors and effects can appear different when illuminated with different light sources. Swarovski uses standard light source D65 for color decision and comparison. Slight changes in shades are unavoidable. Colors may vary according to cut and foiling.

The composition of Advanced Crystal is compliant with regulatory industry norms and laws regarding the restriction or prohibition of certain substances in the most relevant segments of our customers. Please note that the compliance of the colors Light Siam and Siam varies according to certain industry regulations. Those regulations are indicated with \* in the compliance overview. Indian Siam, Ruby and Scarlet (option to Lt. Siam) conform to all CLEAR-lists. For further information please visit [swarovski.com/s-professionals](https://www.swarovski.com/s-professionals)

© 2023 D. Swarovski Distribution GmbH

# Summary

1 2 3  <b>4120</b> 6x4, 8x6, 14x10, 18x13 mm	1 2 3  <b>4327</b> 30x20 mm	1 2 3  <b>4500</b> 3x2, 6x2 mm
 <b>4127</b> 30x22 mm	 <b>4328</b> 6x3.6, 8x4.8 mm	 <b>4501</b> 4x2, 5x2, 5x2.5, 7x3 mm
 <b>4128</b> 6x4, 8x6 mm	 <b>4329</b> 8x7, 10x8.7, 14x12.1 mm	 <b>4502</b> 3x1 mm
 <b>4139</b> 14, 20 mm	 <b>4390</b> 10x7, 14x10, 18x13 mm	 <b>4527</b> 8x6, 14x10, 18x13 mm
 <b>4160</b> 8x6, 10x8, 14x10, 18x13 mm	 <b>4428</b> 1.5, 2, 3, 4, 8 mm	 <b>4547</b> 15x5, 21x7 mm
 <b>4161</b> 15x5 mm	 <b>4447</b> 6, 8, 10, 12 mm	 <b>4568</b> 14x10, 18x13 mm
 <b>4162</b> 10x5.5, 14x7.5, 18x9.5 mm	 <b>4460</b> 8, 10, 14, 18 mm	 <b>4600</b> 6x4, 8x6, 10x8 mm
 <b>4200</b> 11x3, 15x4 mm	 <b>4470</b> 10, 12 mm	 <b>4610</b> 14x10, 18x13 mm
 <b>4228</b> 4x2, 5x2.5, 6x3, 8x4, 10x5, 15x7 mm	 <b>4471</b> 8, 10, 12 mm	 <b>4627</b> 27x18.5 mm
 <b>4320</b> 6x4, 8x6, 10x7, 14x10, 18x13 mm	 <b>4480</b> 6, 8, 10, 14, 18 mm	 <b>4683</b> 7.8x8.7, 10x11.2, 12x13.5, 14x15.8 mm
 <b>4322</b> 10x5 mm	 <b>4483</b> 8, 10, 12, 14 mm	 <b>4706</b> 7, 12, 17 mm

05

1 2 3

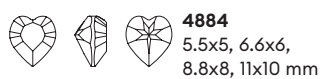

Summary

1 Top view 2 Side view 3 Back view

**4120** Oval Fancy Stone



**Size** 6x4, 8x6, 14x10, 18x13 mm

**4127** Big Oval Fancy Stone

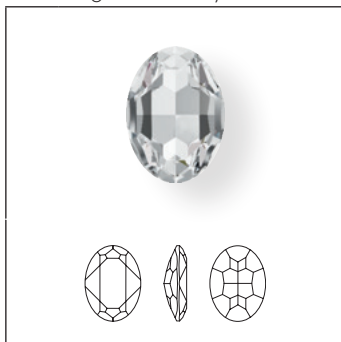

**Size** 30x22 mm







	4122 Big Oval Fancy Stone				4127 Big Oval Fancy Stone
	6x4 mm	8x6 mm	14x10 mm	18x13 mm	30x22 mm
<b>Crystal</b>					
Crystal F (001)	■	■	■	■	■
<b>Colors</b>					
<b>Plain Colors</b>					
Amethyst F (204)	■	■	■	■	■
Aquamarine F (202)	■	■	■	■	■
Black Diamond F (215)	■	■	■	■	■
Chrysolite F (238)	■	■	■	■	■
Citrus Green F (337)	■	■	■	■	■
Denim Blue F (266)	■	■	■	■	■
Emerald F (205)	■	■	■	■	■
Golden Topaz F (1003)*	■	■	■	■	■
Jet (280)	■	■	■	■	■
Light Amber F (1002)*	■	■	■	■	■
Light Amethyst F (212)	■	■	■	■	■
Light Azore F (361)	■	■	■	■	■
Light Colorado Topaz F (246)	■	■	■	■	■
Light Rose F (223)	■	■	■	■	■
Light Topaz F (226)	■	■	■	■	■
Light Turquoise F (263)	■	■	■	■	■
Montana F (207)	■	■	■	■	■
Peridot F (214)	■	■	■	■	■

\* All colors with a 4-digit color code (i.e. Golden Topaz) are fully customizable with shorter lead times and lower MOQs compared to our 3-digit colors. Please get in touch with the Customer Service for a time and quantity estimation of your desired variant.

4120 4127		Size	4122 Big Oval Fancy Stone	6x4 mm	8x6 mm	14x10 mm	18x13 mm	4127 Big Oval Fancy Stone	30x22 mm
	Rose F (209)		■	■	■	■			
	Rose Peach F (262)		■	■	■	■			
	Sapphire F (206)		■	■	■	■			
	Scarlet F (276)		■	■	■	■			
	Siam F (208)		■	■	■	■			
	Smoked Amber F (1001)*		■	■	■	■			
	Tanzanite F (539)		■	■	■	■		■	
	Vintage Rose F (319)		■	■	■	■			
<b>Opal Colors</b>									
	White Opal F (234)		■	■	■	■			■
<b>Crystal Effects</b>									
<b>Transparent Effects</b>									
	Crystal Aurore Boreale F (001 AB)		■	■	■	■			■
	Crystal Golden Shadow F (001 GSHA)		■	■	■	■			■
	Crystal Ignite (001 IGNIT)			■	■	■			
	Crystal Moonlight F (001 MOL)		■	■	■	■			
	Crystal Silver Night F (001 SINI)		■	■	■	■			
	Crystal Silver Shade F (001 SSHA)		■	■	■	■			■
<b>Crystal Lacquer<sup>PRO</sup> Effects</b>									
<b>Crystal Lacquer<sup>PRO</sup> Ignite Effects</b>									
	Crystal Flamingo Ignite (001 L162I)				■	■			■
	Crystal Linen Ignite (001 L164I)				■	■			■
	Crystal Maroon Ignite (001 L160I)				■	■			■
	Crystal Orange Ignite (001 L159I)				■	■			■
	Crystal Purple Ignite (001 L161I)				■	■			■
	Crystal Sky Ignite (001 L163I)				■	■			■
<b>Crystal Lacquer<sup>PRO</sup> DeLite Effects</b>									
	Crystal Dusty Pink DeLite (001 L149D)				■	■			■
	Crystal Ivory Cream DeLite (001 L106D)				■	■			■
	Crystal Lavender DeLite (001 L144D)				■	■			■
	Crystal Royal Blue DeLite (001 L110D)				■	■			■
	Crystal Serene Gray DeLite (001 L150D)				■	■			■

\* All colors with a 4-digit color code (i.e. Golden Topaz) are fully customizable with shorter lead times and lower MOQs compared to our 3-digit colors. Please get in touch with the Customer Service for a time and quantity estimation of your desired variant.



<p><b>4120</b> <b>4127</b></p>		<b>Size</b>	<b>4122 Big Oval Fancy Stone</b>	6x4 mm	8x6 mm	14x10 mm	18x13 mm	<b>4127 Big Oval Fancy Stone</b>	30x22 mm
<b>Color Effects</b>									
<b>Transparent Effects</b>									
	Amethyst Ignite (204 IGNIT)			■	■	■			
	Aquamarine Ignite (204 IGNIT)			■	■	■			
	Emerald Ignite (205 IGNIT)			■	■	■			
	Light Colorado Topaz Ignite (246 IGNIT)			■	■	■			
	Light Rose Ignite (223 IGNIT)			■	■	■			
	Scarlet Ignite (276 IGNIT)			■	■	■			

**4128** XILION Oval Fancy Stone

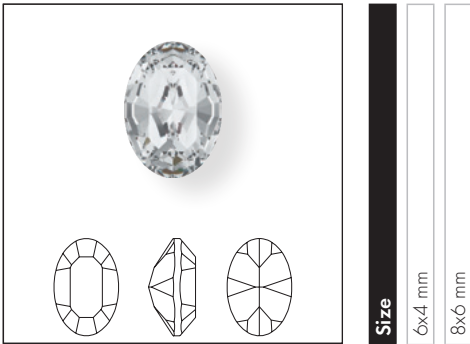

Crystal	
Crystal F (001)	<input type="checkbox"/>
Colors	
Plain Colors	
Amethyst F (204)	<input type="checkbox"/>
Aquamarine F (202)	<input type="checkbox"/>
Black Diamond F (215)	<input type="checkbox"/>
Emerald F (205)	<input type="checkbox"/>
Light Amethyst F (212)	<input type="checkbox"/>
Light Rose F (223)	<input type="checkbox"/>
Montana F (207)	<input type="checkbox"/>
Rose F (209)	<input type="checkbox"/>
Siam F (208)	<input type="checkbox"/>
Crystal Effects	
Transparent Effects	
Crystal Golden Shadow F (001 GSHA)	<input type="checkbox"/>

**4139** Cosmic Ring Fancy Stone



Crystal	
Crystal (001)	<input type="checkbox"/>
Crystal Effects	
Transparent Effects	
Crystal Aurore Boreale (001 AB)	<input type="checkbox"/>
Crystal Bermuda Blue (001 BB)	<input type="checkbox"/>
Crystal Golden Shadow (001 GSHA)	<input type="checkbox"/>
Crystal Silver Night (001 SINI)	<input type="checkbox"/>
Crystal Vitrail Light (001 VL)	<input type="checkbox"/>
Crystal Vitrail Medium (001 VM)	<input type="checkbox"/>
Crystal Volcano (001 VOL)	<input type="checkbox"/>
Metallic Effects	
Crystal Comet Argent Light V SI (001 CAVSI)	<input type="checkbox"/>

**4160** Mystic Oval Fancy Stone



**Crystal**

Crystal F (001)

**Crystal Effects**

**Transparent Effects**

Crystal Aurore Boreale F (001 AB)

Crystal Paradise Shine F (001 PARSH)

Crystal Vitrail Medium F (001 VM)

**Crystal Lacquer<sup>PRO</sup> Effects**

Crystal Flamingo Ignite (001 L162I)

Crystal Linen Ignite (001 L164I)

Crystal Maroon Ignite (001 L160I)

Crystal Orange Ignite (001 L159I)

Crystal Purple Ignite (001 L161I)

Crystal Sky Ignite (001 L163I)

**4161** Long Classic Oval Fancy Stone

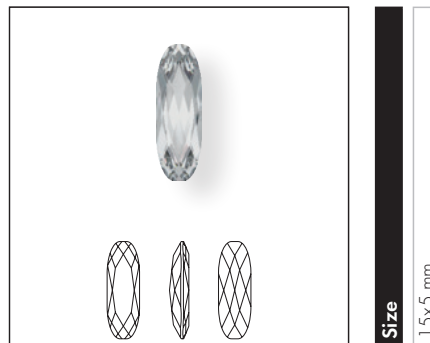

**Crystal**

Crystal F (001)

### 4162 Elongated Oval Fancy Stone

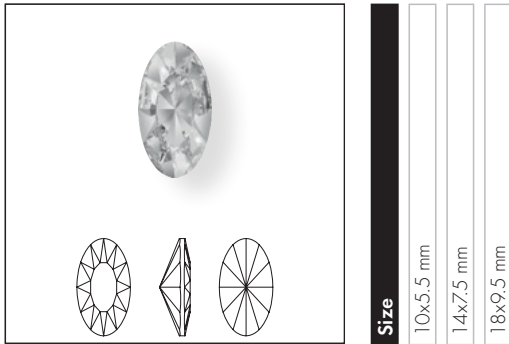

**Size**  
 10x5.5 mm  
 14x7.5 mm  
 18x9.5 mm

Crystal		
Crystal F (001)	<input type="checkbox"/>	<input type="checkbox"/>
Colors		
Plain Colors		
Aquamarine F (202)	<input type="checkbox"/>	<input type="checkbox"/>
Black Diamond F (215)	<input type="checkbox"/>	<input type="checkbox"/>
Emerald F (205)	<input type="checkbox"/>	<input type="checkbox"/>
Iris F (219)	<input type="checkbox"/>	<input type="checkbox"/>
Jet (280)	<input type="checkbox"/>	<input type="checkbox"/>
Light Colorado Topaz F (246)	<input type="checkbox"/>	<input type="checkbox"/>
Montana F (207)	<input type="checkbox"/>	<input type="checkbox"/>
Scarlet F (276)	<input type="checkbox"/>	<input type="checkbox"/>
Vintage Rose F (319)	<input type="checkbox"/>	<input type="checkbox"/>
Crystal Effects		
Transparent Effects		
Crystal Aurore Boreale F (001 AB)	<input type="checkbox"/>	<input type="checkbox"/>
Crystal Golden Shadow F (001 GSHA)	<input type="checkbox"/>	<input type="checkbox"/>
Crystal Silver Shade F (001 SSHA)	<input type="checkbox"/>	<input type="checkbox"/>

### 4200 Sphinx Eye Fancy Stone

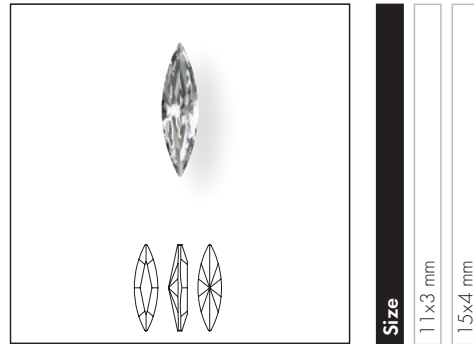

**Size**  
 11x3 mm  
 15x4 mm

Crystal		
Crystal F (001)	<input type="checkbox"/>	<input type="checkbox"/>
Crystal Effects		
Transparent Effects		
Crystal Aurore Boreale F (001 AB)	<input type="checkbox"/>	<input type="checkbox"/>
Crystal Golden Shadow F (001 GSHA)	<input type="checkbox"/>	<input type="checkbox"/>

4228 XILION Navette Fancy Stone

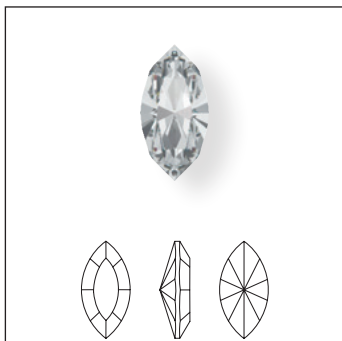





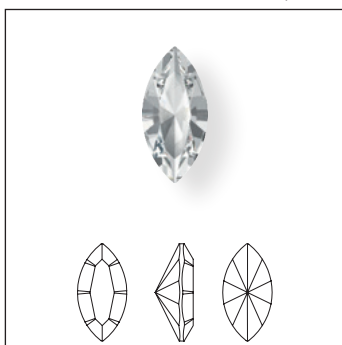



Size 4x2, 5x2.5 mm

4228 XILION Navette Fancy Stone



Size 6x3, 8x4, 10x5, 15x7 mm

4228	Size					
	4x2 mm	5x2.5 mm	6x3 mm	8x4 mm	10x5 mm	15x7 mm
<b>Crystal</b>						
Crystal F (001)	■	■	■	■	■	■
<b>Colors</b>						
<b>Plain Colors</b>						
Amethyst F (204)	■	■	■	■	■	■
Aquamarine F (202)	■	■	■	■	■	■
Black Diamond F (215)	■	■	■	■	■	■
Chrysolite F (238)	■	■	■	■	■	■
Citrus Green F (337)	■	■	■	■	■	■
Denim Blue F (266)	■	■	■	■	■	■
Emerald F (205)	■	■	■	■	■	■
Golden Topaz F (1003)	■	■	■	■	■	■
Jet (280)	■	■	■	■	■	■
Light Amber F (1002)	■	■	■	■	■	■
Light Amethyst F (212)	■	■	■	■	■	■
Light Colorado Topaz F (246)	■	■	■	■	■	■
Light Rose F (223)	■	■	■	■	■	■
Light Sapphire F (211)	■	■	■	■	■	■
Light Siam F (227)	■	■	■	■	■	■
Light Silk F (261)	■	■	■	■	■	■
Light Topaz F (226)	■	■	■	■	■	■
Light Turquoise F (263)	■	■	■	■	■	■
Montana F (207)	■	■	■	■	■	■
Peridot F (214)	■	■	■	■	■	■
Rose F (209)	■	■	■	■	■	■
Rose Peach F (262)	■	■	■	■	■	■
Sapphire F (206)	■	■	■	■	■	■
Scarlet F (276)	■	■	■	■	■	■
Siam F (208)	■	■	■	■	■	■
Smoked Amber F (1001)	■	■	■	■	■	■
Tanzanite F (539)	■	■	■	■	■	■
<b>Opal Colors</b>						
White Opal F (234)	■	■	■	■	■	■
<b>Crystal Effects</b>						
<b>Transparent Effects</b>						
Crystal Aurore Boreale F (001 AB)	■	■	■	■	■	■
Crystal Golden Shadow F (001 GSHA)	■	■	■	■	■	■
Crystal Moonlight F (001 MOL)	■	■	■	■	■	■
Crystal Silver Night F (001 SINI)	■	■	■	■	■	■
Crystal Silver Shade F (001 SSHA)	■	■	■	■	■	■

4228		Size						
		4x2 mm	5x2.5 mm	6x3 mm	8x4 mm	10x5 mm	15x7 mm	
Crystal Lacquer <sup>PRO</sup> Effects								
	Crystal Dusty Pink Delite (001 L149D)						■	
	Crystal Ivory Cream Delite (001 L106D)						■	
	Crystal Lavender Delite (001 L144D)						■	
	Crystal Maroon Ignite (001 L160I)						■	
	Crystal Orange Ignite (001 L159I)						■	
	Crystal Purple Ignite (001 L161I)						■	
	Crystal Royal Blue Delite (001 L110D)						■	
	Crystal Serene Gray Delite (001 L150D)						■	

**4320** Pear Fancy Stone

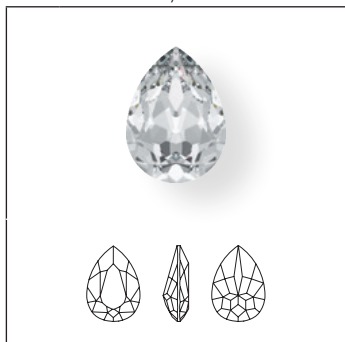

**Size** 6x4, 8x6, 10x7, 14x10, 18x13 mm

**4327** Large Pear Fancy Stone



**Size** 30x20 mm

	6x4 mm	8x6 mm	10x7 mm	14x10 mm	18x13 mm	30x20 mm
<b>4320</b> <b>4327</b>						
<b>Crystal</b>						
Crystal F (001)	■	■	■	■	■	■
<b>Colors</b>						
<b>Plain Colors</b>						
Amethyst F (204)	■	■	■	■	■	■
Aquamarine F (202)	■	■	■	■	■	■
Black Diamond F (215)	■	■	■	■	■	■
Chrysolite F (238)	■	■	■	■	■	■
Citrus Green F (337)	■	■	■	■	■	■
Denim Blue F (266)	■	■	■	■	■	■
Emerald F (205)	■	■	■	■	■	■
Golden Topaz F (1003)*	■	■	■	■	■	■
Iris F (219)	■	■	■	■	■	■
Jet (280)	■	■	■	■	■	■
Light Amber F (1002)*	■	■	■	■	■	■
Light Amethyst F (212)	■	■	■	■	■	■
Light Colorado Topaz F (246)	■	■	■	■	■	■
Light Rose F (223)	■	■	■	■	■	■
Light Silk F (261)	■	■	■	■	■	■
Light Topaz F (226)	■	■	■	■	■	■
Light Turquoise F (263)	■	■	■	■	■	■
Montana F (207)	■	■	■	■	■	■
Peridot F (214)	■	■	■	■	■	■

\* All colors with a 4-digit color code (i.e. Golden Topaz) are fully customizable with shorter lead times and lower MOQs compared to our 3-digit colors. Please get in touch with the Customer Service for a time and quantity estimation of your desired variant.

4320 4327		Size	4320 Pear Fancy Stone	6x4 mm	8x6 mm	10x7 mm	14x10 mm	18x13 mm	4327 Large Pear Fancy Stone	30x20 mm
	Rose F (209)			■	■	■	■	■		
	Rose Peach F (262)			■	■	■	■	■		
	Sapphire F (206)			■	■	■	■	■		
	Scarlet F (276)			■	■	■	■	■		
	Siam F (208)			■	■	■	■	■		
	Smoked Amber F (1001)*			■	■	■	■	■		
	Tanzanite F (539)			■	■	■	■	■	■	
	Vintage Rose F (319)			■	■	■	■	■		
<b>Opal Colors</b>										
	White Opal F (234)			■	■	■	■	■	■	
<b>Crystal Effects</b>										
<b>Transparent Effects</b>										
	Crystal Aurore Boreale F (001 AB)			■	■	■	■	■	■	
	Crystal Golden Shadow F (001 GSHA)			■	■	■	■	■	■	
	Crystal Ignite (001 IGNIT)				■	■	■	■		
	Crystal Moonlight F (001 MOL)			■	■	■	■	■		
	Crystal Silver Night F (001 SINI)			■	■	■	■	■		
	Crystal Silver Shade F (001 SSHA)			■	■	■	■	■	■	
<b>Crystal Lacquer<sup>PRO</sup> Effects</b>										
<b>Crystal Lacquer<sup>PRO</sup> Ignite Effects</b>										
	Crystal Flamingo Ignite (001 L1621)						■	■	■	
	Crystal Linen Ignite (001 L1641)						■	■	■	
	Crystal Maroon Ignite (001 L1601)						■	■	■	
	Crystal Orange Ignite (001 L1591)						■	■	■	
	Crystal Purple Ignite (001 L1611)						■	■	■	
	Crystal Sky Ignite (001 L1631)						■	■	■	

\* All colors with a 4-digit color code (i.e. Golden Topaz) are fully customizable with shorter lead times and lower MOQs compared to our 3-digit colors. Please get in touch with the Customer Service for a time and quantity estimation of your desired variant.



4320 4327		Size	4320 Pear Fancy Stone	6x4 mm	8x6 mm	10x7 mm	14x10 mm	18x13 mm	4327 Large Pear Fancy Stone	30x20 mm	
<b>Crystal Lacquer<sup>PRO</sup> DeLite Effects</b>											
	Crystal Dusty Pink DeLite (001 L149D)						■	■	■		
	Crystal Ivory Cream DeLite (001 L106D)						■	■	■		
	Crystal Laguna DeLite (001 L142D)						■	■	■		
	Crystal Lavender DeLite (001 L144D)						■	■	■		
	Crystal Ocean DeLite (001 L143D)						■	■	■		
	Crystal Royal Blue DeLite (001 L110D)						■	■	■		
	Crystal Serene Gray DeLite (001 L150D)						■	■	■		
	Crystal Silky Sage DeLite (001 L147D)						■	■	■		
<b>Color Effects</b>											
<b>Transparent Effects</b>											
	Amethyst Ignite (204 IGNIT)			■	■	■	■				
	Aquamarine Ignite (204 IGNIT)			■	■	■	■				
	Emerald Ignite (205 IGNIT)			■	■	■	■				
	Light Colorado Topaz Ignite (246 IGNIT)			■	■	■	■				
	Light Rose Ignite (223 IGNIT)			■	■	■	■				
	Scarlet Ignite (276 IGNIT)			■	■	■	■				

### 4322 Teardrop Fancy Stone

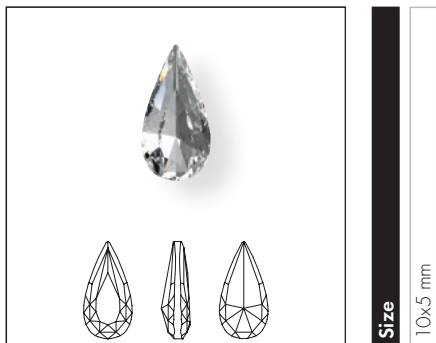

**Size**

10x5 mm

**Crystal**

Crystal F (001)

**Colors**

**Plain Colors**

Vintage Rose F (319)

**Crystal Effects**

**Transparent Effects**

Crystal Aurore Boreale F (001 AB)

Crystal Golden Shadow F (001 GSHA)

Crystal Silver Shade F (001 SSHA)

### 4328 XILLION Pear Fancy Stone



**Size**

6x3.6 mm

8x4.8 mm

**Crystal**

Crystal F (001)

**Colors**

**Plain Colors**

Aquamarine F (202)

Black Diamond F (215)

Emerald F (205)

Light Rose F (223)

Siam F (208)

**Crystal Effects**

**Transparent Effects**

Crystal Golden Shadow F (001 GSHA)

4329 Majestic Fancy Stone



**Size**  
8x7 mm  
10x8.7 mm  
14x12.1 mm

Crystal	8x7 mm	10x8.7 mm	14x12.1 mm
Crystal F (001)	■	■	■
Colors			
Plain Colors			
Amethyst F (204)	■	■	■
Aquamarine F (202)	■	■	■
Citrus Green F (337)	■	■	■
Emerald F (205)	■	■	■
Golden Topaz F (1003)	■	■	■
Jonquil F (213)	■	■	■
Light Amber F (1002)	■	■	■
Light Rose F (223)	■	■	■
Montana F (207)	■	■	■
Scarlet F (276)	■	■	■
Crystal Effects			
Transparent Effects			
Crystal Golden Shadow F (001 GSHA)	■	■	■
Crystal Ignite (001 IGNIT)	■	■	■
Crystal Silver Night (001 SINI)	■	■	■
Color Effects			
Transparent Effects			
Amethyst Ignite (204 IGNIT)	■	■	■
Aquamarine Ignite (202 IGNIT)	■	■	■
Emerald Ignite (205 IGNIT)	■	■	■
Light Rose Ignite (223 IGNIT)	■	■	■
Scarlet Ignite (276 IGNIT)	■	■	■

4390 Mirage Pear Fancy Stone



**Size**  
10x7 mm  
14x10 mm  
18x13 mm

Crystal	10x7 mm	14x10 mm	18x13 mm
Crystal F (001)	■	■	■
Colors			
Plain Colors			
Amethyst F (204)	■	■	■
Aquamarine F (202)	■	■	■
Black Diamond F (215)	■	■	■
Emerald F (205)	■	■	■
Light Colorado Topaz F (246)	■	■	■
Light Rose F (223)	■	■	■
Montana F (207)	■	■	■
Scarlet F (276)	■	■	■
Crystal Effects			
Transparent Effects			
Crystal Aurore Boreale F (001 AB)	■	■	■
Crystal Paradise Shine F (001 PARSH)	■	■	■
Crystal Silver Night F (001 SINI)	■	■	■
Crystal Vitrail Medium F (001 VM)	■	■	■

**4428** XILION Square Fancy Stone

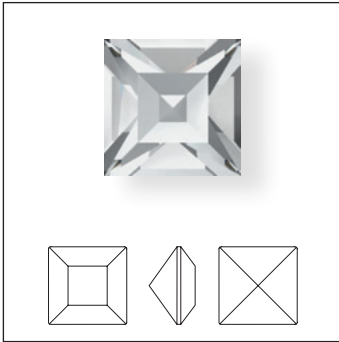

**Size** 1.5, 2 mm

**4428** XILION Square Fancy Stone

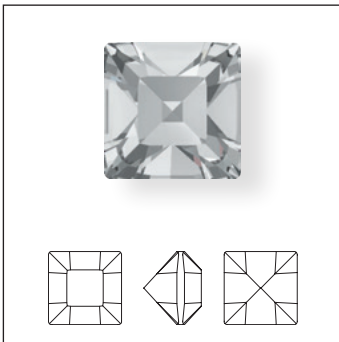

**Size** 3, 4 mm

**4428** XILION Square Fancy Stone

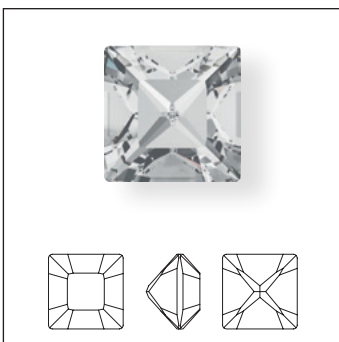

**Size** 8 mm

	<b>Size</b>				
	1.5 mm	2 mm	3 mm	4 mm	8 mm
<b>Crystal</b>					
Crystal F (001)	■	■	■	■	■
<b>Colors</b>					
<b>Plain Colors</b>					
Amethyst F (204)	■	■	■	■	■
Aquamarine F (202)	■	■	■	■	■
Black Diamond F (215)	■	■	■	■	■
Citrus Green F (337)	■	■	■	■	■
Emerald F (205)	■	■	■	■	■
Jet (280)	■	■	■	■	■
Jet F (280)	■	■	■	■	■
Light Amethyst F (212)	■	■	■	■	■
Light Colorado Topaz F (246)	■	■	■	■	■
Light Rose F (223)	■	■	■	■	■
Light Sapphire F (211)	■	■	■	■	■
Light Siam F (227)	■	■	■	■	■
Light Topaz F (226)	■	■	■	■	■
Light Turquoise F (263)	■	■	■	■	■
Montana F (207)	■	■	■	■	■
Peridot F (214)	■	■	■	■	■
Rose F (209)	■	■	■	■	■
Rose Peach F (262)	■	■	■	■	■
Sapphire F (206)	■	■	■	■	■
Scarlet F (276)	■	■	■	■	■
Siam F (208)	■	■	■	■	■
Tanzanite F (539)	■	■	■	■	■
<b>Crystal Effects</b>					
<b>Transparent Effects</b>					
Crystal Aurore Boreale F (001 AB)	■	■	■	■	■
Crystal Golden Shadow F (001 GSHA)	■	■	■	■	■
Crystal Silver Night F (001 SINI)	■	■	■	■	■
Crystal Silver Shade F (001 SSHA)	■	■	■	■	■

**4447** Princess Square Fancy Stone



**Size**

- 6 mm
- 8 mm
- 10 mm
- 12 mm

**Crystal**

- Crystal F (001)

**4460** Mystic Square Fancy Stone

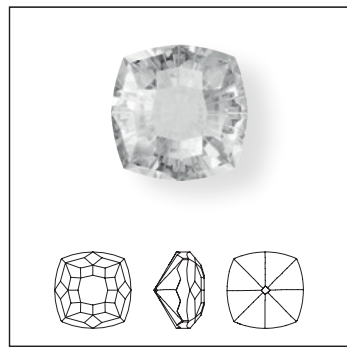

**Size**

- 8 mm
- 10 mm
- 14 mm
- 18 mm

**Crystal**

- Crystal F (001)

**Colors**

**Plain Colors**

- Amethyst F (204)
- Aquamarine F (202)
- Emerald F (205)
- Iris F (219)
- Light Colorado Topaz F (246)
- Scarlet F (276)

**Crystal Effects**

**Transparent Effects**

- Crystal Aurore Boreale F (001 AB)
- Crystal Paradise Shine F (001 PARSH)
- Crystal Vitrail Medium F (001 VM)

**Crystal Lacquer<sup>PRO</sup> Effects**

- Crystal Flamingo Ignite (001 L162I)
- Crystal Linen Ignite (001 L164I)
- Crystal Maroon Ignite (001 L160I)
- Crystal Orange Ignite (001 L159I)
- Crystal Purple Ignite (001 L161I)
- Crystal Sky Ignite (001 L163I)

**Color Effects**

**Transparent Effects**

- Light Topaz Shimmer F (226 SHIM)

05

**4470** Cushion Square Fancy Stone

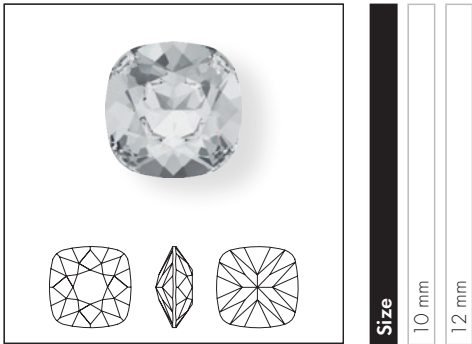

**Size**  
10 mm  
12 mm

**Crystal**

Crystal F (001)

**Colors**

**Plain Colors**

Amethyst F (204)

Aquamarine F (202)

Black Diamond F (215)

Chrysolite F (238)

Citrus Green F (337)

Denim Blue F (266)

Emerald F (205)

Golden Topaz F (1003)

Iris F (219)

Jet (280)

Light Amber F (1002)

Light Amethyst F (212)

Light Azure F (361)

Light Colorado Topaz F (246)

Light Rose F (223)

Light Sapphire F (211)

Light Siam F (227)

Light Topaz F (226)

Light Turquoise F (263)

Peridot F (214)

Rose Peach F (262)

Sapphire F (206)

Scarlet F (276)

Siam F (208)

Smoked Amber F (1001)

Tanzanite F (539)

Vintage Rose F (319)

**Opal Colors**

White Opal F (234)

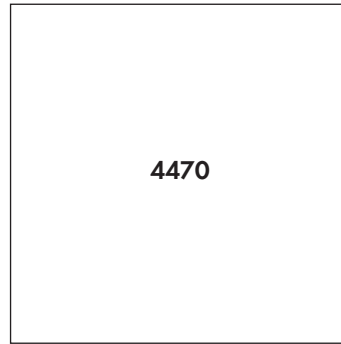

**Size**  
10 mm  
12 mm

**Crystal Effects**

**Transparent Effects**

Crystal Aurore Boreale F (001 AB)

Crystal Bermuda Blue F (001 BB)

Crystal Golden Shadow F (001 GSHA)

Crystal Ignite (001 IGNIT)

Crystal Moonlight F (001 MOL)

Crystal Silver Night F (001 SINI)

Crystal Silver Shade F (001 SSHA)

**Crystal Lacquer<sup>PRO</sup> Effects**

Crystal Dusty Pink DeLite (001 L149D)

Crystal Flamingo Ignite (001 L162I)

Crystal Ivory Cream DeLite (001 L106D)

Crystal Laguna DeLite (001 L142D)

Crystal Lavender DeLite (001 L144D)

Crystal Linen Ignite (001 L164I)

Crystal Lotus Pink DeLite (001 L145D)

Crystal Maroon Ignite (001 L160I)

Crystal Ocean DeLite (001 L143D)

Crystal Orange Glow DeLite (001 L146D)

Crystal Orange Ignite (001 L159I)

Crystal Purple Ignite (001 L161I)

Crystal Royal Blue DeLite (001 L110D)

Crystal Royal Red DeLite (001 L107D)

Crystal Serene Gray DeLite (001 L150D)

Crystal Silky Sage DeLite (001 L147D)

Crystal Sky Ignite (001 L163I)

**Color Effects**

**Transparent Effects**

Amethyst Ignite (204 IGNIT)

Aquamarine Ignite (202 IGNIT)

Emerald Ignite (205 IGNIT)

Light Colorado Topaz Ignite (246 IGNIT)

Light Rose Ignite (223 IGNIT)

Scarlet Ignite (276 IGNIT)

4471 Rose Cut Cushion Fancy Stone



**Size**  
8 mm  
10 mm  
12 mm

Crystal	8 mm	10 mm	12 mm
Crystal F (001)	■	■	■
Colors			
Plain Colors			
Vintage Rose F (319)	■	■	■
Opal Colors			
Rose Water Opal F (395)	■	■	■
White Opal F (234)	■	■	■
Crystal Effects			
Transparent Effects			
Crystal Aurore Boreale F (001 AB)	■	■	■
Crystal Golden Shadow F (001 GSHA)	■	■	■

4480 Imperial Fancy Stone



**Size**  
6 mm  
8 mm  
10 mm  
14 mm  
18 mm

Crystal	6 mm	8 mm	10 mm	14 mm	18 mm
Crystal F (001)	■	■	■	■	■
Colors					
Plain Colors					
Amethyst F (204)	■	■	■	■	■
Aquamarine F (202)	■	■	■	■	■
Emerald F (205)	■	■	■	■	■
Jet (280)	■	■	■	■	■
Light Colorado Topaz F (246)	■	■	■	■	■
Light Rose F (223)	■	■	■	■	■
Montana F (207)	■	■	■	■	■
Scarlet F (276)	■	■	■	■	■
Crystal Effects					
Transparent Effects					
Crystal Aurore Boreale F (001 AB)	■	■	■	■	■
Crystal Golden Shadow F (001 GSHA)	■	■	■	■	■
Crystal Silver Night (001 SINI)	■	■	■	■	■
Crystal Silver Shade F (001 SSHA)	■	■	■	■	■

**4483 Fantasy Cushion Fancy Stone**



Size	8 mm	10 mm	12 mm	14 mm
------	------	-------	-------	-------

- Crystal**
- Crystal F (001)
- Colors**
- Plain Colors**
- Vintage Rose F (319)
- Crystal Effects**
- Transparent Effects**
- Crystal Golden Shadow F (001 GSHA)
- Crystal Silver Night (001 SINI)
- Crystal Lacquer<sup>PRO</sup> Effects**
- Crystal Flamingo Ignite (001 L1621)
- Crystal Linen Ignite (001 L1641)
- Crystal Sky Ignite (001 L1631)

**4500 Thin Baguette Fancy Stone**

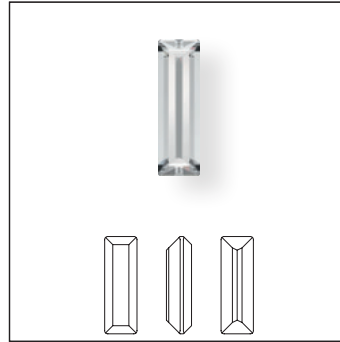

Size	3x2 mm	6x2 mm
------	--------	--------

- Crystal**
- Crystal (001)
- Crystal F (001)



### 4501 Baguette Fancy Stone

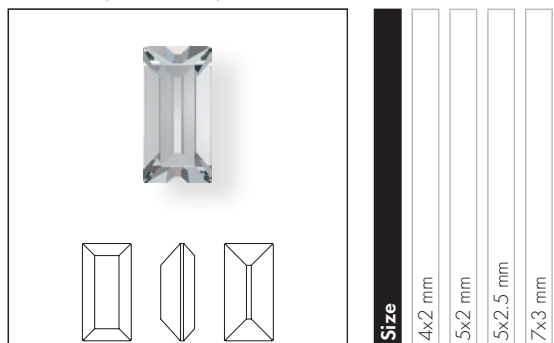

**Crystal**

Crystal F (001)

**Colors**

**Plain Colors**

Amethyst F (204)

Aquamarine F (202)

Black Diamond F (215)

Citrus Green F (337)

Emerald F (205)

Jet (280)

Light Amethyst F (212)

Light Colorado Topaz F (246)

Light Rose F (223)

Light Sapphire F (211)

Light Topaz F (226)

Light Turquoise F (263)

Montana F (207)

Peridot F (214)

Rose F (209)

Sapphire F (206)

Scarlet F (276)

Siam F (208)

Tanzanite F (539)

**Crystal Effects**

**Transparent Effects**

Crystal Aurore Boreale F (001 AB)

Crystal Golden Shadow F (001 GSHA)

Crystal Silver Night F (001 SINI)

Crystal Silver Shade F (001 SSHA)

### 4502 Small Baguette Fancy Stone

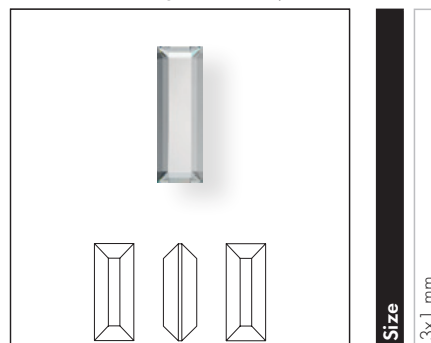

**Crystal**

Crystal (001)

Crystal F (001)

**4527** Step Cut Fancy Stone

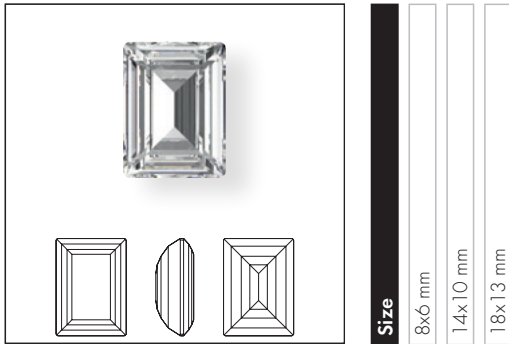

**Size**  
8x6 mm  
14x10 mm  
18x13 mm

**Crystal**

Crystal F (001)

**Colors**

**Plain Colors**

Erinite F (360)

Light Amethyst F (212)

Montana F (207)

Tanzanite F (539)

**Crystal Effects**

**Transparent Effects**

Crystal Golden Shadow F (001 GSHA)

Crystal Moonlight F (001 MOL)

**4547** Princess Baguette Fancy Stone

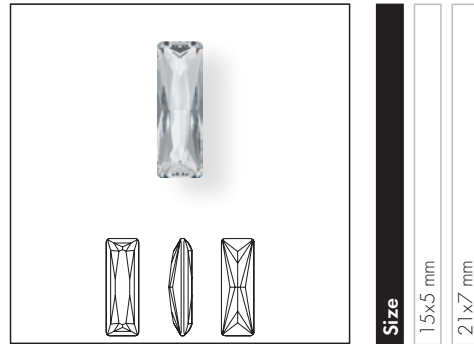

**Size**  
15x5 mm  
21x7 mm

**Crystal**

Crystal F (001)

**4568** Cushion Fancy Stone

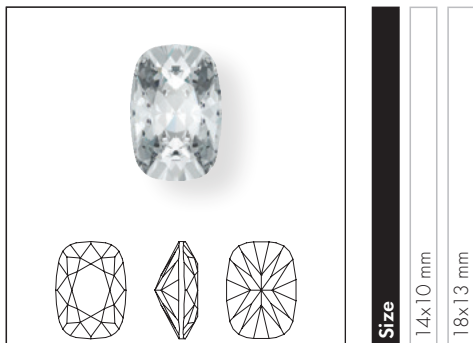

**Size**  
14x10 mm  
18x13 mm

- Crystal**
- Crystal F (001)
- Crystal Effects**
- Transparent Effects**
- Crystal Golden Shadow F (001 GSHA)
- Crystal Silver Night (001 SINI)
- Crystal Silver Shade F (001 SSHA)

**4600** Octagon Fancy Stone

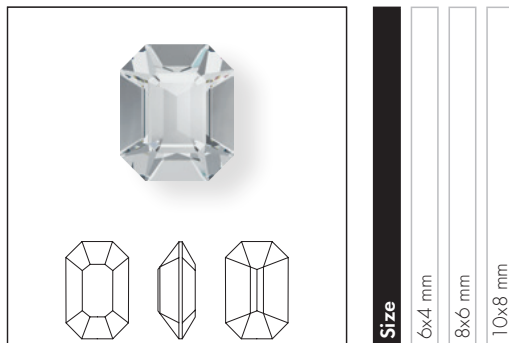

**Size**  
6x4 mm  
8x6 mm  
10x8 mm

- Crystal**
- Crystal F (001)
- Crystal Effects**
- Transparent Effects**
- Crystal Golden Shadow F (001 GSHA)
- Crystal Silver Shade F (001 SSHA)

**4610** Curved Back Octagon Fancy Stone

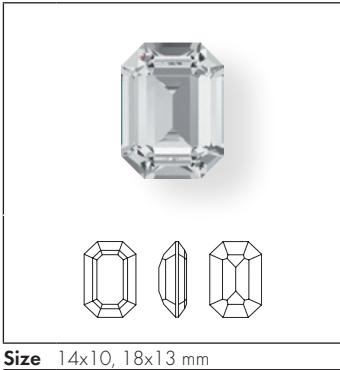

**Size** 14x10, 18x13 mm

**4627** Thin Octagon Fancy Stone

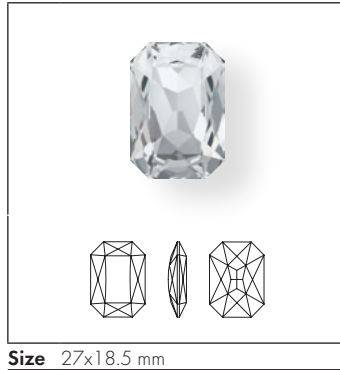

**Size** 27x18.5 mm

	4610 Curved Back Octagon F. Stone	4627 Thin Octagon Fancy Stone
<b>Crystal</b>		
Crystal F (001)	■	■
<b>Colors</b>		
<b>Plain Colors</b>		
Amethyst F (204)	■	■
Aquamarine F (202)	■	■
Black Diamond F (215)	■	■
Emerald F (205)	■	■
Jet (280)	■	■
Light Colorado Topaz F (246)	■	■
Montana F (207)	■	■
Peridot F (214)	■	■
Siam F (208)	■	■
Tanzanite F (539)	■	■
<b>Crystal Effects</b>		
<b>Transparent Effects</b>		
Crystal Golden Shadow F (001 GSHA)	■	■
Crystal Silver Shade F (001 SSHA)	■	■
<b>Crystal Lacquer<sup>PRO</sup> Effects</b>		
<b>Crystal Lacquer<sup>PRO</sup> Ignite Effects</b>		
Crystal Flamingo Ignite (001 L1621)		■
Crystal Linen Ignite (001 L1641)		■
Crystal Sky Ignite (001 L1631)		■

**4683** Fantasy Hexagon Fancy Stone



Crystal	7.8x8.7 mm	10x11.2 mm	12x13.5 mm	14x15.8 mm
Crystal F (001)	■	■	■	■
Colors				
Plain Colors				
Vintage Rose F (319)	■	■	■	■
Crystal Effects				
Transparent Effects				
Crystal Golden Shadow F (001 GSHA)	■	■	■	■
Crystal Silver Night (001 SINI)	■	■	■	■

**4706** Trilliant Fancy Stone



Crystal	7 mm	12 mm	17 mm
Crystal F (001)	■	■	■
Colors			
Plain Colors			
Amethyst F (204)	■	■	■
Aquamarine F (202)	■	■	■
Light Colorado Topaz F (246)	■	■	■
Rose F (209)	■	■	■
Scarlet F (276)	■	■	■
Tanzanite F (539)	■	■	■
Vintage Rose F (319)	■	■	■
Crystal Effects			
Transparent Effects			
Crystal Aurore Boreale F (001 AB)	■	■	■
Crystal Blue Shade F (001 BLSH)	■	■	■
Crystal Golden Shadow F (001 GSHA)	■	■	■
Crystal Silver Night (001 SINI)	■	■	■
Crystal Silver Shade F (001 SSHA)	■	■	■
Crystal Volcano F (001 VOL)	■	■	■

05

**4722** Triangle Fancy Stone

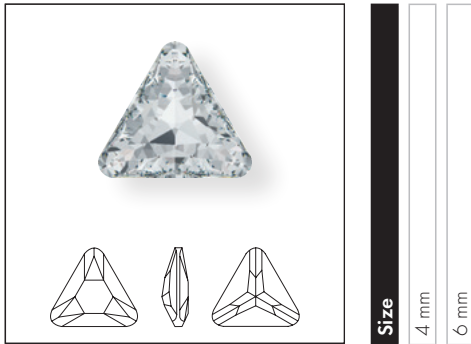

**Size**  
4 mm  
6 mm

**Crystal**

Crystal F (001)

**4744** Rivoli Flower Fancy Stone

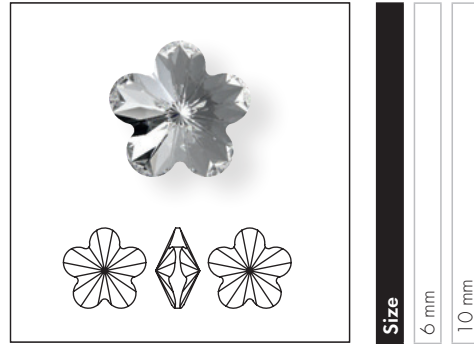

**Size**  
6 mm  
10 mm

**Crystal**

Crystal F (001)

**Colors**

**Plain Colors**

Aquamarine F (202)

Fuchsia F (502)

Light Rose F (223)

Violet F (371)

**Crystal Effects**

**Transparent Effects**

Crystal Aurore Boreale F (001 AB)

4745 Rivoli Star Fancy Stone



Size  
5 mm  
10 mm

- Crystal**
- Crystal F (001)
- Colors**
- Plain Colors**
- Jet (280)
- Crystal Effects**
- Transparent Effects**
- Crystal Aurore Boreale F (001 AB)
- Crystal Bermuda Blue F (001 BB)
- Crystal Golden Shadow F (001 GSHA)
- Crystal Silver Shade F (001 SSHA)
- Crystal Vitrail Light F (001 VL)
- Crystal Vitrail Medium F (001 VM)

4809 Sweet Heart Fancy Stone

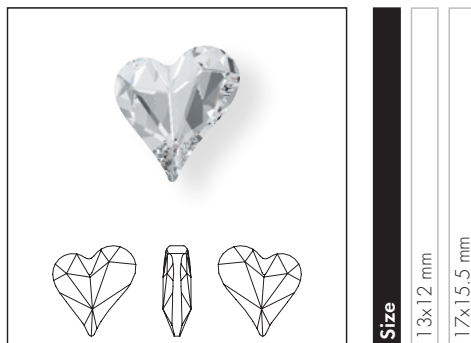

Size  
13x12 mm  
17x15.5 mm

- Crystal**
- Crystal F (001)
- Colors**
- Plain Colors**
- Amethyst F (204)
- Light Siam F (227)
- Rosaline F (508)
- Rose F (209)
- Rose Peach F (262)
- Violet F (371)
- Crystal Effects**
- Transparent Effects**
- Crystal Aurore Boreale F (001 AB)
- Crystal Blue Shade F (001 BLSH)
- Crystal Golden Shadow F (001 GSHA)
- Crystal Silver Night (001 SINI)

### 4841 Cube Fancy Stone

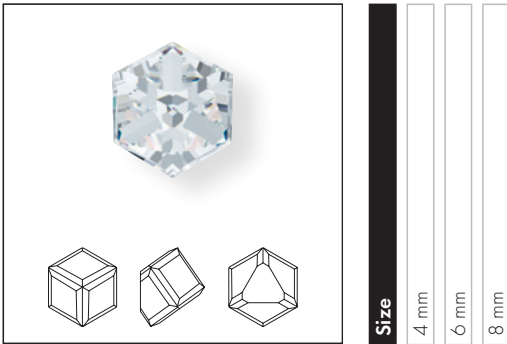

**Size**  
4 mm  
6 mm  
8 mm

Crystal			
Crystal Comet Argent Light V Z (001 CAVZ)	■	■	■
Crystal Effects			
Transparent Effects			
Crystal Aurore Boreale CAL V Z (001 ABCVZ)	■	■	■
Crystal Vitrail Light Z (001 VLZ)	■	■	■
Crystal Vitrail Medium Z (001 VMZ)	■	■	■
Crystal Bermuda Blue Z (001 BBZ)	■	■	■
Crystal Golden Shadow CAL V Z (001 GSCVZ)	■	■	■
Color Effects			
Aquamarine Comet Argent Light V Z (202 CAVZ)	■	■	■
Light Rose Comet Argent Light V Z (223 CAVZ)	■	■	■
Light Siam Comet Argent Light V Z (227 CAVZ)	■	■	■

### 4869 Disco Fancy Stone

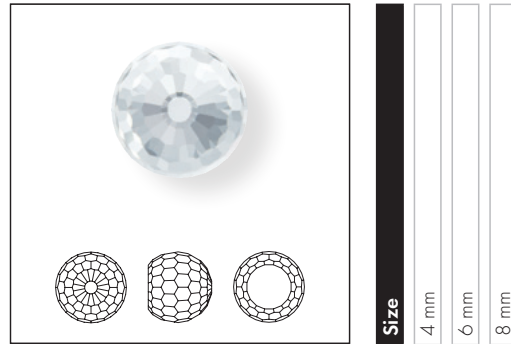

**Size**  
4 mm  
6 mm  
8 mm

Crystal			
Crystal Comet Argent Light V Z (001 CAVZ)	■	■	■
Crystal Effects			
Transparent Effects			
Crystal Aurore Boreale CAL V Z (001 ABCVZ)	■	■	■
Crystal Vitrail Medium Z (001 VMZ)	■	■	■



4884 XILION Heart Fancy Stone



Size
5.5x5 mm
6.6x6 mm
8.8x8 mm
11x10 mm

**Crystal**

Crystal F (001)

**Colors**

**Plain Colors**

Aquamarine F (202)

Light Amethyst F (212)

Light Rose F (223)

Light Siam F (227)

Peridot F (214)

Rose F (209)

Crystal F (001)	■	■	■	■
Aquamarine F (202)	■	■	■	
Light Amethyst F (212)	■	■	■	
Light Rose F (223)	■	■	■	
Light Siam F (227)	■	■	■	
Peridot F (214)	■	■	■	
Rose F (209)	■	■	■	

# Product Details

Article Size	Packing Unit = Minimum Order Quantity in Pieces	Average Net Weight in Gram per Packing Unit Crystal (001)	Average Gross Weight in Gram per Packing Unit Crystal (001)
<b>4120</b>			
6x4 mm	360	31.2	42.1
8x6 mm	180	44.7	45.2
14x10 mm	144	170.2	193.8
18x13 mm	48	112.3	132.9
<b>4127</b>			
30x22 mm	24	173.6	218.7
<b>4128</b>			
6x4 mm	360	26.8	37.6
8x6 mm	360	76.5	87.3
<b>4139</b>			
14 mm	72	53.2	82.7
20 mm	24	46.7	78.7
<b>4160</b>			
8x6 mm	90	23.9	43.5
10x8 mm	72	40.1	59.8
14x10 mm	48	65.9	85.6
18x13 mm	24	70.7	90.3
<b>4161</b>			
15x5 mm	72	29.5	51.6
<b>4162</b>			
10x5.5 mm	144	23.8	34.9
14x7.5 mm	72	36.0	56.4
18x9.5 mm	48	49.6	70.5
<b>4200</b>			
11x3 mm	360	28.6	39.4
15x4 mm	144	26.2	37.1
<b>4228</b>			
4x2 mm	720	9.2	18.3
5x2.5 mm	720	18.9	28.0
6x3 mm	720	30.5	39.6
8x4 mm	360	32.9	42.0
10x5 mm	360	60.7	72.1
15x7 mm	144	63.9	88.1
<b>4320</b>			
6x4 mm	360	25.7	34.8
8x6 mm	180	30.7	39.8
10x7 mm	144	48.6	68.9
14x10 mm	144	126.6	150.2
18x13 mm	48	85.2	105.8
<b>4322</b>			
10x5 mm	72	13.95	33.93
<b>4327</b>			
30x20 mm	24	161.8	206.8
<b>4328</b>			
6x3.6 mm	720	40.0	50.5
8x4.8 mm	360	42.1	53.0

Article Size	Packing Unit = Minimum Order Quantity in Pieces	Average Net Weight in Gram per Packing Unit Crystal (001)	Average Gross Weight in Gram per Packing Unit Crystal (001)
<b>4329</b>			
8x7 mm	90	23.9	45.3
10x8.7 mm	72	30.5	48.9
14x12.1 mm	24	26.5	47.2
<b>4390</b>			
10x7 mm	144	45.3	70.4
14x10 mm	144	125.4	150.9
18x13 mm	48	87.4	111.8
<b>4428</b>			
1.5 mm	1,440	4.32	15.1
2 mm	1,440	12.2	23.0
3 mm	1,440	34.8	57.6
4 mm	1,440	108.5	119.5
8 mm	144	84.5	99.6
<b>4447</b>			
6 mm	360	87.5	98.3
8 mm	144	71.5	91.9
10 mm	144	133.9	157.2
12 mm	72	117.6	137.9
<b>4460</b>			
8 mm	72	32.1	49.2
10 mm	48	41.1	58.8
14 mm	24	55.1	70.4
18 mm	15	70.5	88.7
<b>4470</b>			
10 mm	144	91.6	111.9
12 mm	72	74.7	92.9
<b>4471</b>			
8 mm	144	41.3	66.4
10 mm	96	54.3	77.5
12 mm	48	43.3	67.6
<b>4480</b>			
6 mm	288	50.02	73.28
8 mm	144	65.95	87.79
10 mm	96	86.30	110.13
14 mm	48	115.2	136.1
18 mm	15	75.0	92.9
<b>4483</b>			
8 mm	144	63.3	88.4
10 mm	96	77.76	104.6
12 mm	48	66.7	91.1
14 mm	24	53.0	72.8
<b>4500</b>			
3x2 mm	1,440	20.5	32.0
6x2 mm	720	18.4	27.5

Article Size	Packing Unit = Minimum Order Quantity in Pieces	Average Net Weight in Gram per Packing Unit Crystal (001)	Average Gross Weight in Gram per Packing Unit Crystal (001)
<b>4501</b>			
4x2 mm	720	16.8	25.9
5x2 mm	720	18.1	27.2
5x2.5 mm	720	20.9	30.0
7x3 mm	720	60.2	71.1
<b>4502</b>			
3x1 mm	720	2.2	11.4
<b>4527</b>			
8x6 mm	144	53.7	64.6
14x10 mm	72	122.4	144.9
18x13 mm	72	246.9	270.6
<b>4547</b>			
15x5 mm	72	37.4	58.9
21x7 mm	48	65.3	98.7
<b>4568</b>			
14x10 mm	72	74.9	103.1
18x13 mm	24	46.2	64.7
<b>4600</b>			
6x4 mm	360	40.9	51.8
8x6 mm	144	41.2	52.2
10x8 mm	144	84.0	104.0
<b>4610</b>			
14x10 mm	144	171.3	194.9
18x13 mm	48	124.9	145.5
<b>4627</b>			
27x18.5 mm	24	125.3	170.8
<b>4683</b>			
7.8x8.7 mm	144	57.3	80.5
10x11.2 mm	96	75.8	99.4
12x13.5 mm	48	61.0	84.7
14x15.8 mm	24	46.4	67.0
<b>4706</b>			
7 mm	144	23.7	44.4
12 mm	72	61.5	83.9
17 mm	48	96.4	119.8
<b>4722</b>			
4 mm	480	12.0	21.1
6 mm	180	16.4	25.5
<b>4744</b>			
6 mm	720	62.3	72.8
10 mm	288	126.0	158.1
<b>4745</b>			
5 mm	720	35.6	46.4
10 mm	144	48.5	71.3

Article Size	Packing Unit = Minimum Order Quantity in Pieces	Average Net Weight in Gram per Packing Unit Crystal (001)	Average Gross Weight in Gram per Packing Unit Crystal (001)
<b>4809</b>			
13x12 mm	72	47.8	68.5
17x15.5 mm	48	69.3	93.7
<b>4841</b>			
4 mm	288	45.3	66.6
6 mm	144	77.2	95.3
8 mm	72	89.2	107.4
<b>4869</b>			
4 mm	480	36.2	45.3
6 mm	180	47.2	56.4
8 mm	144	90.8	109.0
<b>4884</b>			
5.5x5 mm	360	39.0	49.7
6.6x6 mm	360	67.2	78.0
8.8x8 mm	288	111.4	138.1
11x10 mm	144	107.3	127.4

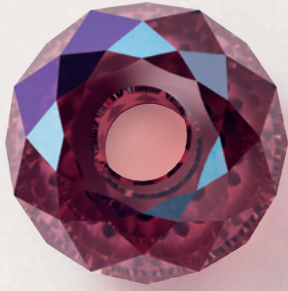

# Beads

Swarovski Beads set the benchmark for excellence in the market. Meticulously crafted, precision-cut with a clear hole, and extraordinary brilliance, the rounded edge of the hole reduces the wear on threads to increase design durability. Available in a wide range of shapes and cuts, from classically elegant through to playful and modern, they offer myriad creative possibilities.

With a large assortment of vibrant colors, and effects they are predominantly applied using beading, wiring, stringing and weaving. Various hole diameters open up new, unlimited application, and design possibilities, particularly for apparel and accessories embellishment.







## Colors & Effects

OPEN TO SEE COLORS & EFFECTS















## Colors

 Crystal 001	 Light Sapphire 211
 White Opal 234	 Sapphire 206
 Light Silk 261	 Capri Blue 243
 Silk 391	 Majestic Blue 296
 Light Peach 362	 Dark Indigo 288
 Rosaline 508	 Montana 207
 Rose Water Opal 395	 Denim Blue 266
 Vintage Rose 319	 Light Turquoise 263
 Blush Rose 257	 Blue Zircon 229
 Light Rose 223	 Erinite 360
 Rose Peach 262	 Peridot 214
 Padparadscha 542	 Citrus Green 337
 Rose 209	 Fern Green 291
 Fuchsia 502	 Emerald 205
 Light Siam 227	 Jonquil 213
 Scarlet 276	 Light Topaz 226
 Siam 208	 Sunflower 292
 Ruby 501	 Golden Topaz 1003
 Amethyst 204	 Light Colorado Topaz 246
 Iris 219	 Topaz 203
 Light Amethyst 212	 Light Amber 1002
 Violet 371	 Smoked Amber 1001
 Tanzanite 539	 Greige 284
 Purple Velvet 277	 Black Diamond 215
 Light Azore 361	 Jet 280
 Aquamarine 202	









## Effects

 Crystal Moonlight 001 MOL	 Light Amethyst Shimmer 212 SHIM
 Crystal Shimmer 001 SHIM	 Aquamarine Shimmer 202 SHIM
 Crystal Aurore Boreale 001 AB	 Light Sapphire Shimmer 211 SHIM
 Crystal Antique Pink 001 ANTP	 Peridot Shimmer 214 SHIM
 Crystal Paradise Shine 001 PARSH	 Erinite Shimmer 360 SHIM
 Crystal Vitrail Medium 001 VM	 Emerald Shimmer 205 SHIM
 Crystal Blue Shade 001 BLSH	 Light Topaz Shimmer 226 SHIM
 Crystal Golden Shadow 001 GSHA	 Light Colorado Topaz Shimmer 246 SHIM
 Crystal Metallic Sunshine 001 METSH	 Black Diamond Shimmer 215 SHIM
 Crystal Rose Gold 001 ROGL	 Jet Shimmer 280 SHIM
 Crystal Metallic Light Gold 001 MLGLD	

## AB Effects

 Light Rose Aurore Boreale 223 AB
 Rose Aurore Boreale 209 AB
 Light Siam Aurore Boreale 227 AB
 Amethyst Aurore Boreale 204 AB
 Iris Aurore Boreale 219 AB
 Violet Aurore Boreale 371 AB
 Purple Velvet Aurore Boreale 277 AB
 Aquamarine Aurore Boreale 202 AB
 Light Sapphire Aurore Boreale 211 AB
 Sapphire Aurore Boreale 206 AB
 Capri Blue Aurore Boreale 243 AB
 Peridot Aurore Boreale 214 AB
 Fern Green Aurore Boreale 291 AB
 Jet Aurore Boreale 280 AB

## Shimmer Effects

 White Opal Shimmer 234 SHIM
 Rose Water Opal Shimmer 395 SHIM
 Light Rose Shimmer 223 SHIM
 Rose Shimmer 209 SHIM
 Light Siam Shimmer 227 SHIM
 Scarlet Shimmer 276 SHIM
 Siam Shimmer 208 SHIM
 Amethyst Shimmer 204 SHIM

## Numerical Order

001	Crystal	211 AB	Light Sapphire Aurore Boreale	276 SHIM	Scarlet Shimmer
001 AB	Crystal Aurore Boreale	211 SHIM	Light Sapphire Shimmer	276	Scarlet
001 ANTP	Crystal Antique Pink	211	Light Sapphire	277 AB	Purple Velvet Aurore Boreale
001 BLSH	Crystal Blue Shade	212 SHIM	Light Amethyst Shimmer	277	Purple Velvet
001 CAL	Crystal Comet Argent Light	212	Light Amethyst	280 AB	Jet Aurore Boreale
001 GSHA	Crystal Golden Shadow	213	Jonquil	280 HEM	Jet Hematite
001 LTCH	Crystal Light Chrome	214 AB	Peridot Aurore Boreale	280 SHIM	Jet Shimmer
001 METSH	Crystal Metallic Sunshine	214 SHIM	Peridot Shimmer	280	Jet
001 MLGLD	Crystal Metallic Light Gold	214	Peridot	284	Greige
001 MOL	Crystal Moonlight	215 SHIM	Black Diamond Shimmer	288	Dark Indigo
001 PARSH	Crystal Paradise Shine	215	Black Diamond	291 AB	Fern Green Aurore Boreale
001 ROGL	Crystal Rose Gold	219 AB	Iris Aurore Boreale	291	Fern Green
001 SHIM	Crystal Shimmer	219	Iris	292	Sunflower
001 SINI	Crystal Silver Night	223 AB	Light Rose Aurore Boreale	296	Majestic Blue
001 SSHA	Crystal Silver Shade	223 SHIM	Light Rose Shimmer	319	Vintage Rose
001 VM	Crystal Vitrail Medium	223	Light Rose	337	Citrus Green
202 AB	Aquamarine Aurore Boreale	226 SHIM	Light Topaz Shimmer	360 SHIM	Erinite Shimmer
202 SHIM	Aquamarine Shimmer	226	Light Topaz	360	Erinite
202	Aquamarine	227 AB	Light Siam Aurore Boreale	361	Light Azore
203	Topaz	227 SHIM	Light Siam Shimmer	362	Light Peach
204 AB	Amethyst Aurore Boreale	227	Light Siam	371 AB	Violet Aurore Boreale
204 SHIM	Amethyst Shimmer	229	Blue Zircon	371	Violet
204	Amethyst	234 SHIM	White Opal Shimmer	391	Silk
205 SHIM	Emerald Shimmer	234	White Opal	395 SHIM	Rose Water Opal Shimmer
205	Emerald	243 AB	Capri Blue Aurore Boreale	395	Rose Water Opal
206 AB	Sapphire Aurore Boreale	243	Capri Blue	501	Ruby
206	Sapphire	246 SHIM	Light Colorado Topaz Shimmer	502	Fuchsia
207	Montana	246	Light Colorado Topaz	508	Rosaline
208 SHIM	Siam Shimmer	257	Blush Rose	539	Tanzanite
208	Siam	261	Light Silk	542	Padparadscha
209 AB	Rose Aurore Boreale	262	Rose Peach	1001	Smoked Amber
209 SHIM	Rose Shimmer	263	Light Turquoise	1002	Light Amber
209	Rose	266	Denim Blue	1003	Golden Topaz

## Alphabetical Order

Amethyst (204)	Erinite (360)	Light Turquoise (263)
Amethyst Aurore Boreale (204 AB)	Erinite Shimmer (360 SHIM)	Majestic Blue (296)
Amethyst Shimmer (204 SHIM)	Fern Green (291)	Montana (207)
Aquamarine (202)	Fern Green Aurore Boreale (291 AB)	Padparadscha (542)
Aquamarine Aurore Boreale (202 AB)	Fuchsia (502)	Peridot (214)
Aquamarine Shimmer (202 SHIM)	Golden Topaz (1003)	Peridot Aurore Boreale (214 AB)
Black Diamond (215)	Greige (284)	Peridot Shimmer (214 SHIM)
Black Diamond Shimmer (215 SHIM)	Iris (219)	Purple Velvet (277)
Blue Zircon (229)	Iris Aurore Boreale (219 AB)	Purple Velvet Aurore Boreale (277 AB)
Blush Rose (257)	Jet (280)	Rosaline (508)
Capri Blue (243)	Jet Aurore Boreale (280 AB)	Rose (209)
Capri Blue Aurore Boreale (243 AB)	Jet Hematite (280 HEM)	Rose Aurore Boreale (209 AB)
Citrus Green (337)	Jet Shimmer (280 SHIM)	Rose Peach (262)
Crystal (001)	Jonquil (213)	Rose Shimmer (209 SHIM)
Crystal Antique Pink (001 ANTP)	Light Amber (1002)	Rose Water Opal (395)
Crystal Aurore Boreale (001 AB)	Light Amethyst (212)	Rose Water Opal Shimmer (395 SHIM)
Crystal Blue Shade (001 BLSH)	Light Amethyst Shimmer (212 SHIM)	Ruby (501)
Crystal Comet Argent Light (001 CAL)	Light Azore (361)	Sapphire (206)
Crystal Golden Shadow (001 GSHA)	Light Colorado Topaz (246)	Sapphire Aurore Boreale (206 AB)
Crystal Light Chrome (001 LTCH)	Light Colorado Topaz Shimmer (246 SHIM)	Scarlet (276)
Crystal Metallic Light Gold (001 MLGLD)	Light Peach (362)	Scarlet Shimmer (276 SHIM)
Crystal Metallic Sunshine (001 METSH)	Light Rose (223)	Siam (208)
Crystal Moonlight (001 MOL)	Light Rose Aurore Boreale (223 AB)	Siam Shimmer (208 SHIM)
Crystal Paradise Shine (001 PARSH)	Light Rose Shimmer (223 SHIM)	Silk (391)
Crystal Rose Gold (001 ROGL)	Light Sapphire (211)	Smoked Amber (1001)
Crystal Shimmer (001 SHIM)	Light Sapphire Aurore Boreale (211 AB)	Sunflower (292)
Crystal Silver Night (001 SINI)	Light Sapphire Shimmer (211 SHIM)	Tanzanite (539)
Crystal Silver Shade (001 SSHA)	Light Siam (227)	Topaz (203)
Crystal Vitrail Medium (001 VM)	Light Siam Aurore Boreale (227 AB)	Vintage Rose (319)
Dark Indigo (288)	Light Siam Shimmer (227 SHIM)	Violet (371)
Denim Blue (266)	Light Silk (261)	Violet Aurore Boreale (371 AB)
Emerald (205)	Light Topaz (226)	White Opal (234)
Emerald Shimmer (205 SHIM)	Light Topaz Shimmer (226 SHIM)	White Opal Shimmer (234 SHIM)

For details on available colors and effects for each article within the product groups, please see the product matrix of the respective item in the Collection 2023.

The plating resistance of effects is tested according to Swarovski's plating guidelines (SWAROVSKI.COM/S-PROFESSIONALS). Customers are advised to carry out their own tests if their plating parameters diverge from Swarovski plating guidelines.

For more 1x/2x effect options please refer to the specific article overviews.

Colors and effects can appear different when illuminated with different light sources. Swarovski uses standard light source D65 for color decision and comparison. Slight changes in shades are unavoidable. Colors may vary according to cut and foiling.

The composition of Advanced Crystal is compliant with regulatory industry norms and laws regarding the restriction or prohibition of certain substances in the most relevant segments of our customers. Please note that the compliance of the colors Light Siam and Siam varies according to certain industry regulations. Those regulations are indicated with \* in the compliance overview. Indian Siam, Ruby and Scarlet (option to Lt. Siam) conform to all CLEAR-lists. For further information please visit [swarovski.com/s-professionals](http://swarovski.com/s-professionals)

© 2023 D. Swarovski Distribution GmbH

# Summary

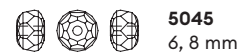
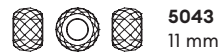
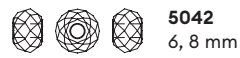
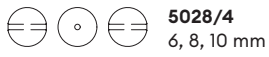
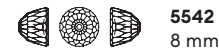
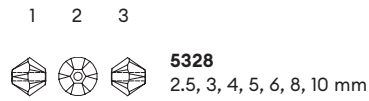

5000 Classic Bead

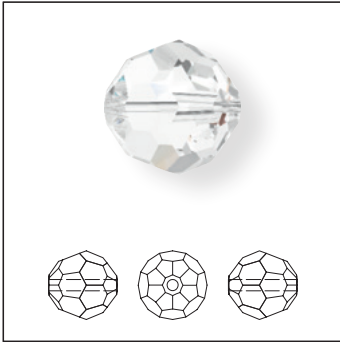

Size	2 mm	3 mm	4 mm	5 mm	6 mm	8 mm	10 mm	12 mm
------	------	------	------	------	------	------	-------	-------

**Crystal**

Crystal (001)

**Colors**

**Plain Colors**

- Amethyst (204)
- Aquamarine (202)
- Black Diamond (215)
- Blue Zircon (229)
- Capri Blue (243)
- Citrus Green (337)
- Denim Blue (266)
- Emerald (205)
- Erinite (360)
- Fuchsia (502)
- Golden Topaz (1003)
- Jet (280)
- Jonquil (213)
- Light Amber (1002)
- Light Amethyst (212)
- Light Azore (361)
- Light Colorado Topaz (246)
- Light Rose (223)
- Light Sapphire (211)
- Light Siam (227)
- Light Topaz (226)
- Light Turquoise (263)
- Montana (207)
- Peridot (214)
- Rose (209)
- Rose Peach (262)
- Sapphire (206)
- Scarlet (276)
- Siam (208)
- Silk (391)
- Smoked Amber (1001)
- Tanzanite (539)
- Topaz (203)
- Vintage Rose (319)
- Violet (371)

Crystal (001)	■	■	■	■	■	■	■	■
Amethyst (204)		■	■	■		■	■	■
Aquamarine (202)	■	■	■	■	■	■	■	
Black Diamond (215)	■		■	■	■	■		
Blue Zircon (229)			■		■	■		
Capri Blue (243)			■		■	■		
Citrus Green (337)			■		■	■		
Denim Blue (266)	■	■	■	■	■	■		
Emerald (205)	■	■	■	■	■	■	■	
Erinite (360)			■		■	■		
Fuchsia (502)		■	■		■	■		
Golden Topaz (1003)			■		■			
Jet (280)	■	■	■	■	■	■	■	
Jonquil (213)			■		■	■		
Light Amber (1002)			■		■			
Light Amethyst (212)			■		■	■		
Light Azore (361)			■		■	■		
Light Colorado Topaz (246)	■	■	■	■	■	■	■	
Light Rose (223)	■	■	■	■	■	■	■	
Light Sapphire (211)			■		■	■		
Light Siam (227)	■	■	■		■	■	■	
Light Topaz (226)			■		■	■		
Light Turquoise (263)			■		■	■		
Montana (207)	■	■	■	■	■	■		
Peridot (214)			■		■	■		
Rose (209)	■	■	■	■	■	■		
Rose Peach (262)			■		■	■		
Sapphire (206)			■		■	■		
Scarlet (276)		■	■		■	■	■	
Siam (208)	■	■	■		■	■	■	
Silk (391)			■		■	■		
Smoked Amber (1001)			■		■			
Tanzanite (539)	■		■		■	■		
Topaz (203)			■		■	■		
Vintage Rose (319)	■	■	■	■	■	■		
Violet (371)			■		■	■		

		2 mm	3 mm	4 mm	5 mm	6 mm	8 mm	10 mm	12 mm
<b>5000</b>	<b>Size</b>								
<b>Opal Colors</b>									
White Opal (234)			■	■		■	■		
<b>Crystal Effects</b>									
<b>Transparent Effects</b>									
Crystal Aurore Boreale (001 AB)		■	■	■	■	■	■	■	■
Crystal Blue Shade (001 BLSH)				■		■	■		
Crystal Golden Shadow (001 GSHA)		■	■	■		■	■	■	
Crystal Moonlight (001 MOL)		■		■		■	■		
Crystal Shimmer (001 SHIM)				■		■	■		
Crystal Silver Night (001 SINI)		■	■	■		■	■		
Crystal Silver Shade (001 SSHA)		■	■	■		■	■		
<b>Metallic Effects</b>									
Crystal Light Chrome (001 LTCH)		■	■	■		■	■		
Crystal Rose Gold (001 ROGL)			■	■		■			
<b>Color Effects</b>									
<b>Transparent Effects</b>									
Amethyst Shimmer (204 SHIM)				■		■	■		
Aquamarine Shimmer (202 SHIM)				■		■	■		
Jet Aurore Boreale (280 AB)				■		■	■		
Light Amethyst Shimmer (212 SHIM)				■		■	■		
Light Rose Shimmer (223 SHIM)				■		■	■		
Light Siam Aurore Boreale (227 AB)				■		■	■		
Peridot Shimmer (214 SHIM)				■		■	■		
Rose Aurore Boreale (209 AB)				■		■	■		
Rose Shimmer (209 SHIM)				■		■	■		
Rose Water Opal Shimmer (395 SHIM)				■		■	■		
Siam Shimmer (208 SHIM)				■		■	■		
White Opal Shimmer (234 SHIM)				■		■	■		



**5003** Disco Ball Bead



Crystal	6 mm	8 mm	10 mm	12 mm
Crystal (001)	■	■	■	■
<b>Crystal Effects</b>				
<b>Transparent Effects</b>				
Crystal Aurore Boreale (001 AB)	■	■	■	■

**5020** Helix Bead

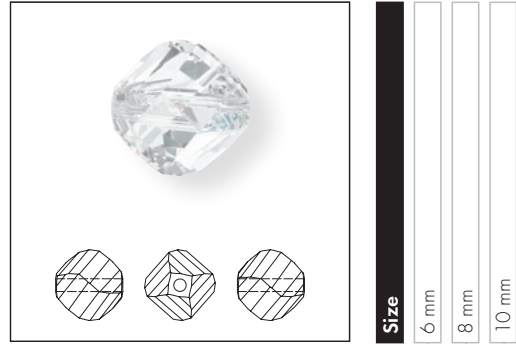

Crystal	6 mm	8 mm	10 mm
Crystal (001)	■	■	■
<b>Crystal Effects</b>			
<b>Transparent Effects</b>			
Crystal Aurore Boreale (001 AB)	■	■	■
Crystal Golden Shadow (001 GSHA)	■	■	■

**5028/4** Crystal Globe Bead

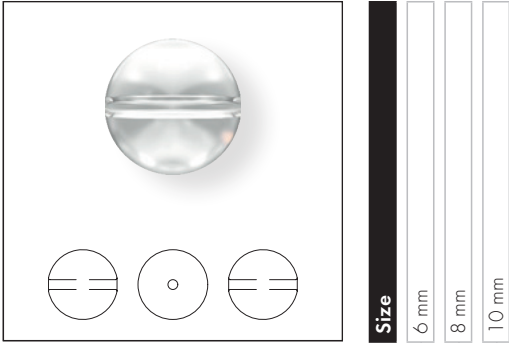

Crystal	6 mm	8 mm	10 mm
Crystal (001)	■	■	■
<b>Crystal Effects</b>			
<b>Transparent Effects</b>			
Crystal Aurore Boreale (001 AB)	■	■	■

5040 Briolette Bead

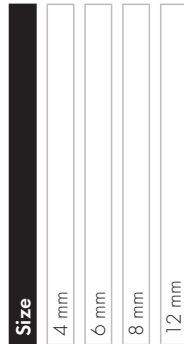

**Crystal**

Crystal (001)

**Colors**

**Plain Colors**

- Amethyst (204)
- Aquamarine (202)
- Blue Zircon (229)
- Emerald (205)
- Erinite (360)
- Iris (219)
- Jet (280)
- Light Amethyst (212)
- Light Colorado Topaz (246)
- Light Rose (223)
- Light Sapphire (211)
- Light Siam (227)
- Light Topaz (226)
- Light Turquoise (263)
- Peridot (214)
- Rose (209)
- Sapphire (206)
- Scarlet (276)
- Siam (208)
- Tanzanite (539)
- Topaz (203)
- Violet (371)

**Crystal Effects**

**Transparent Effects**

- Crystal Aurore Boreale (001 AB)
- Crystal Golden Shadow (001 GSHA)
- Crystal Shimmer 2X (001 SHIM2X)
- Crystal Silver Night (001 SINI)
- Crystal Silver Shade (001 SSHA)

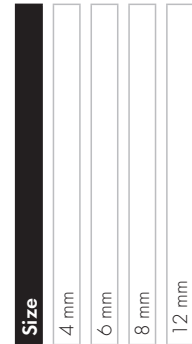
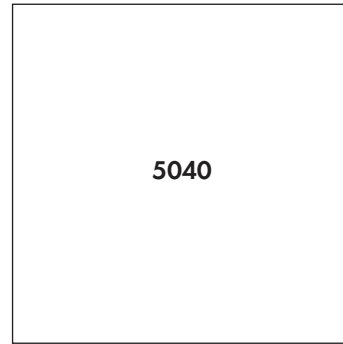

**Color Effects**

**Transparent Effects**

- Amethyst Shimmer 2X (204 SHIM2X)
- Aquamarine Shimmer 2x (202 SHIM2)
- Black Diamond Shimmer 2X (215 SHIM2X)
- Erinite Shimmer 2X (360 SHIM2X)
- Light Amethyst Shimmer 2x (212 SHIM2X)
- Light Colorado Topaz Shimmer 2X (246 SHIM2X)
- Light Rose Shimmer 2X (223 SHIM2X)
- Light Sapphire Shimmer 2X (211 SHIM2X)
- Light Siam Shimmer 2X (227 SHIM2X)
- Light Topaz Shimmer 2X (226 SHIM2X)
- Rose Water Opal Shimmer 2X (395 SHIM2X)
- White Opal Shimmer 2X (234 SHIM2X)

**5042** Briolette XL Hole Bead

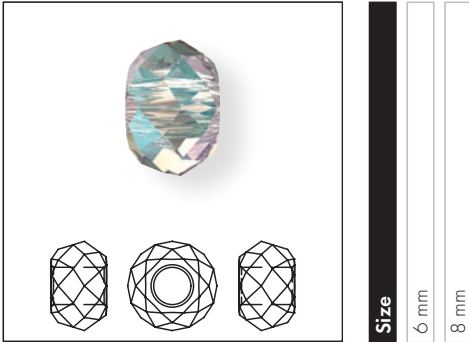

**Size**  
6 mm  
8 mm

**Crystal Effects**

**Transparent Effects**

Crystal Shimmer 2X (001 SHIM2X)

**Color Effects**

**Transparent Effects**

Amethyst Shimmer 2X (204 SHIM2X)

Aquamarine Shimmer 2x (202 SHIM2)

Emerald Shimmer 2X (205 SHIM2X)

Jet Shimmer 2X (280 SHIM2X)

Light Colorado Topaz Shimmer 2X (246 SHIM2X)

Scarlet Shimmer 2X (276 SHIM2X)

**5043** Briolette XXL Hole Bead

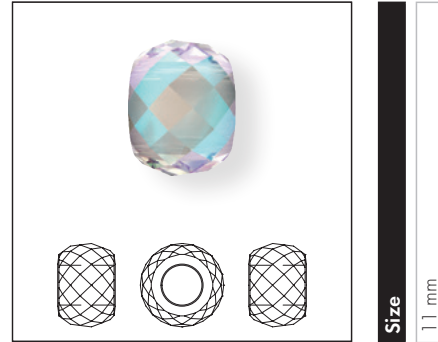

**Size**  
11 mm

**Crystal Effects**

**Transparent Effects**

Crystal Shimmer 2X (001 SHIM2X)

**Color Effects**

**Transparent Effects**

Amethyst Shimmer 2X (204 SHIM2X)

Aquamarine Shimmer 2x (202 SHIM2)

Emerald Shimmer 2X (205 SHIM2X)

Jet Shimmer 2X (280 SHIM2X)

Light Colorado Topaz Shimmer 2X (246 SHIM2X)

Scarlet Shimmer 2X (276 SHIM2X)

**5044** Olive Briolette Bead



**Size**  
5x4 mm  
7x6 mm  
9,5x8 mm

Crystal		
Crystal (001)	■	■
Colors		
Plain Colors		
Amethyst (204)	■	■
Aquamarine (202)	■	■
Blue Zircon (229)	■	■
Emerald (205)	■	■
Jet (280)	■	■
Light Amber (1002)	■	■
Light Rose (223)	■	■
Light Siam (227)	■	■
Light Turquoise (263)	■	■
Peridot (214)	■	■
Rose Peach (262)	■	■
Violet (371)	■	■
Crystal Effects		
Transparent Effects		
Crystal Aurore Boreale (001 AB)	■	■
Crystal Golden Shadow (001 GSHA)	■	■

**5045** Rondelle Bead



**Size**  
6 mm  
8 mm

Crystal		
Crystal (001)	■	■
Crystal Effects		
Transparent Effects		
Crystal Aurore Boreale (001 AB)	■	■

**5305** Slim XILLION Bead

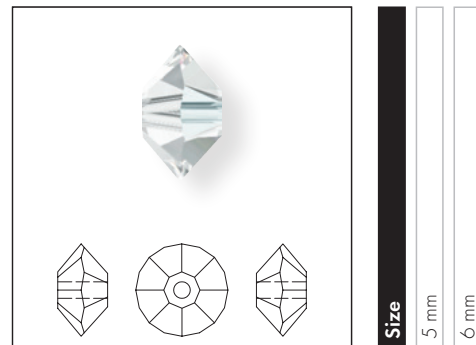

**Size**  
5 mm  
6 mm

Crystal		
Crystal (001)	■	■
Crystal Effects		
Transparent Effects		
Crystal Aurore Boreale (001 AB)	■	■

5328 XILION Bead



Size	2.5 mm	3 mm	4 mm	5 mm	6 mm	8 mm	10 mm
------	--------	------	------	------	------	------	-------

**Crystal**

Crystal (001)

**Colors**

**Plain Colors**

- Amethyst (204)
- Aquamarine (202)
- Black Diamond (215)
- Blue Zircon (229)
- Blush Rose (257)
- Capri Blue (243)
- Citrus Green (337)
- Dark Indigo (288)
- Denim Blue (266)
- Emerald (205)
- Erinite (360)
- Fern Green (291)
- Fuchsia (502)
- Golden Topaz (1003)
- Greige (284)
- Iris (219)
- Jet (280)
- Jonquil (213)
- Light Amber (1002)
- Light Amethyst (212)
- Light Azore (361)
- Light Colorado Topaz (246)
- Light Peach (362)
- Light Rose (223)
- Light Sapphire (211)
- Light Siam (227)
- Light Silk (261)
- Light Topaz (226)
- Light Turquoise (263)
- Majestic Blue (296)
- Montana (207)

Crystal (001)	■	■	■	■	■	■	■
Amethyst (204)	■	■	■	■	■	■	■
Aquamarine (202)	■	■	■	■	■	■	■
Black Diamond (215)		■	■	■	■	■	■
Blue Zircon (229)		■	■	■	■	■	■
Blush Rose (257)		■	■	■	■		
Capri Blue (243)		■	■	■	■		
Citrus Green (337)		■	■	■	■		
Dark Indigo (288)		■	■		■		
Denim Blue (266)		■	■	■	■		
Emerald (205)	■	■	■	■	■	■	
Erinite (360)		■	■	■	■		
Fern Green (291)		■	■		■		
Fuchsia (502)		■	■	■	■		
Golden Topaz (1003)		■	■				
Greige (284)		■	■				
Iris (219)		■	■	■	■		
Jet (280)	■	■	■	■	■	■	
Jonquil (213)		■	■				
Light Amber (1002)		■	■				
Light Amethyst (212)		■	■	■	■		
Light Azore (361)		■	■	■	■		
Light Colorado Topaz (246)	■	■	■	■	■	■	
Light Peach (362)		■	■	■	■		
Light Rose (223)	■	■	■	■	■	■	
Light Sapphire (211)		■	■	■	■		
Light Siam (227)		■	■	■	■	■	
Light Silk (261)		■	■		■		
Light Topaz (226)		■	■	■	■		
Light Turquoise (263)		■	■	■	■	■	
Majestic Blue (296)		■	■	■	■		
Montana (207)		■	■	■	■		

5328	Size						
	2.5 mm	3 mm	4 mm	5 mm	6 mm	8 mm	10 mm
Padparadscha (542)		■	■				
Peridot (214)		■	■	■	■	■	■
Purple Velvet (277)		■	■		■		
Rosaline (508)		■	■	■	■		
Rose (209)		■	■	■	■		
Rose Peach (262)		■	■	■	■		
Ruby (501)		■	■	■	■		
Sapphire (206)		■	■	■	■	■	
Scarlet (276)	■	■	■	■	■		
Siam (208)		■	■	■	■	■	
Silk (391)		■	■	■	■		
Smoked Amber (1001)		■	■				
Sunflower (292)		■	■		■		
Tanzanite (539)		■	■	■	■		
Topaz (203)		■	■	■	■		
Vintage Rose (319)		■	■	■	■		
Violet (371)		■	■	■	■		
<b>Opal Colors</b>							
Rose Water Opal (395)		■	■	■	■		
White Opal (234)		■	■	■	■		
<b>Crystal Effects</b>							
<b>Transparent Effects</b>							
Crystal Antique Pink (001 ANTP)		■	■				
Crystal Aurore Boreale (001 AB)	■	■	■	■	■	■	■
Crystal Aurore Boreale 2x (001 AB2)		■	■	■	■		
Crystal Blue Shade (001 BLSH)		■	■	■	■		
Crystal Golden Shadow (001 GSHA)	■	■	■	■	■	■	
Crystal Moonlight (001 MOL)		■	■	■	■		
Crystal Paradise Shine (001 PARSH)		■	■	■	■		
Crystal Paradise Shine 2x (001 PARS2)			■				
Crystal Shimmer (001 SHIM)		■	■	■	■		
Crystal Shimmer 2X (001 SHIM2X)		■	■				
Crystal Silver Night (001 SINI)		■	■	■			
Crystal Silver Shade (001 SSHA)	■	■	■	■	■	■	
Crystal Vitrail Medium (001 VM)		■	■				

5328	Size							
	2.5 mm	3 mm	4 mm	5 mm	6 mm	8 mm	10 mm	
<b>Metallic Effects</b>								
Crystal Comet Argent Light (001 CAL)		■	■	■	■			
Crystal Light Chrome (001 LTCH)		■	■					
Crystal Light Chrome 2x (001 LTCH2)			■					
Crystal Metallic Light Gold 2x (001 MLG2)		■	■		■			
Crystal Metallic Sunshine (001 METSH)		■	■	■	■			
Crystal Metallic Sunshine 2x (001 MTSH2)			■					
Crystal Rose Gold (001 ROGL)		■	■					
Crystal Rose Gold 2x (001 ROGL2)		■	■	■	■			
<b>Color Effects</b>								
<b>Transparent Effects</b>								
Amethyst Aurore Boreale (204 AB)		■	■					
Amethyst Shimmer (204 SHIM)		■	■		■			
Amethyst Shimmer 2X (204 SHIM2X)		■	■					
Aquamarine Aurore Boreale (202 AB)		■	■					
Aquamarine Shimmer (202 SHIM)		■	■	■	■			
Aquamarine Shimmer 2x (202 SHIM2)		■	■					
Black Diamond Shimmer (215 SHIM)		■	■		■			
Black Diamond Shimmer 2X (215 SHIM2X)		■	■					
Capri Blue Aurore Boreale (243 AB)		■	■					
Fern Green Aurore Boreale (291 AB)		■	■		■			
Iris Aurore Boreale 2X (219 AB2)		■	■					
Jet Aurore Boreale (280 AB)		■	■	■	■			
Jet Aurore Boreale 2x (280 AB2)		■	■					
Light Amethyst Shimmer (212 SHIM)		■	■		■			
Light Amethyst Shimmer 2x (212 SHIM2X)		■	■					
Light Rose Aurore Boreale (223 AB)		■	■	■	■			
Light Rose Aurore Boreale 2x (223 AB2)		■	■					
Light Rose Shimmer (223 SHIM)		■	■		■			
Light Rose Shimmer 2X (223 SHIM2X)		■	■					
Light Sapphire Aurore Boreale (211 AB)		■	■					
Light Sapphire Shimmer 2X (211 SHIM2X)		■	■					
Light Siam Aurore Boreale (227 AB)		■	■					
Light Siam Shimmer 2X (227 SHIM2X)		■	■					
Peridot Aurore Boreale (214 AB)			■					
Peridot Shimmer (214 SHIM)		■	■	■	■			
Peridot Shimmer 2x (214 SHIM2X)		■	■					

	5328								
	Size	2.5 mm	3 mm	4 mm	5 mm	6 mm	8 mm	10 mm	
Purple Velvet Aurore Boreale (277 AB)			■	■			■		
Rose Aurore Boreale (209 AB)			■	■					
Rose Shimmer (209 SHIM)			■	■			■		
Rose Shimmer 2x (209 SHIM2X)			■	■					
Rose Water Opal Shimmer (395 SHIM)			■	■	■		■		
Rose Water Opal Shimmer 2X (395 SHIM2X)			■	■					
Sapphire Aurore Boreale (206 AB)			■	■					
Siam Shimmer (208 SHIM)			■	■			■		
Siam Shimmer 2x (208 SHIM2X)			■	■					
Violet Aurore Boreale (371 AB)			■	■					
White Opal Shimmer (234 SHIM)			■	■	■		■		
White Opal Shimmer 2X (234 SHIM2X)			■	■					
<b>Metallic Effects</b>									
Jet Hematite (280 HEM)			■	■					
Jet Hematite 2x (280 HEM2)			■	■					



5500 Drop Bead

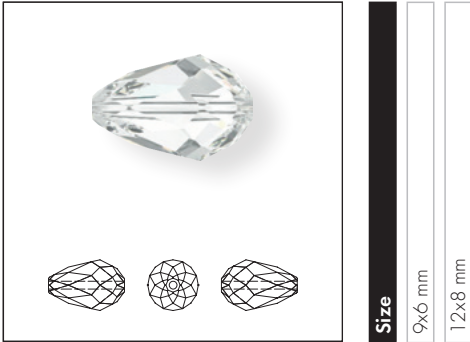

Size

9x6 mm

12x8 mm

Crystal

Crystal (001)

Colors

Plain Colors

- Amethyst (204)
- Aquamarine (202)
- Blue Zircon (229)
- Citrus Green (337)
- Emerald (205)
- Light Amethyst (212)
- Light Colorado Topaz (246)
- Light Rose (223)
- Light Siam (227)
- Light Topaz (226)
- Peridot (214)
- Rose (209)
- Sapphire (206)
- Scarlet (276)
- Siam (208)
- Topaz (203)

Crystal Effects

Transparent Effects

- Crystal Aurore Boreale (001 AB)
- Crystal Golden Shadow (001 GSHA)
- Crystal Shimmer 2X (001 SHIM2X)

Color Effects

Transparent Effects

- Amethyst Shimmer 2X (204 SHIM2X)
- Aquamarine Shimmer 2x (202 SHIM2)
- Light Colorado Topaz Shimmer 2X (246 SHIM2X)
- Light Siam Shimmer 2X (227 SHIM2X)

5542 Dome Bead small

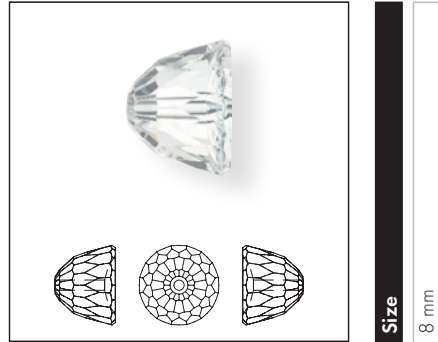

Size

8 mm

Crystal

Crystal (001)

Crystal Effects

Transparent Effects

- Crystal Aurore Boreale (001 AB)
- Crystal Golden Shadow (001 GSHA)

5601 Cube Bead

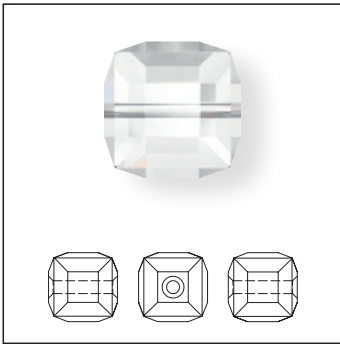

Size	4 mm	6 mm	8 mm	10 mm	12 mm
------	------	------	------	-------	-------

**Crystal**

Crystal (001)

**Colors**

**Plain Colors**

Amethyst (204)

Aquamarine (202)

Black Diamond (215)

Blue Zircon (229)

Blush Rose (257)

Emerald (205)

Erinite (360)

Fuchsia (502)

Iris (219)

Jet (280)

Light Colorado Topaz (246)

Light Sapphire (211)

Light Siam (227)

Light Topaz (226)

Light Turquoise (263)

Majestic Blue (296)

Peridot (214)

Rose Peach (262)

Sapphire (206)

Siam (208)

Smoked Amber (1001)

Tanzanite (539)

Topaz (203)

**Opal Colors**

Rose Water Opal (395)

White Opal (234)

Crystal (001)	■	■	■	■	■
Amethyst (204)	■	■	■		
Aquamarine (202)	■	■	■		
Black Diamond (215)	■	■	■		
Blue Zircon (229)	■	■	■		
Blush Rose (257)	■	■	■		
Emerald (205)	■	■	■		
Erinite (360)	■	■	■		
Fuchsia (502)		■	■		
Iris (219)	■	■	■		
Jet (280)	■	■	■		
Light Colorado Topaz (246)	■	■	■		
Light Sapphire (211)	■	■	■		
Light Siam (227)	■	■	■		
Light Topaz (226)	■	■	■		
Light Turquoise (263)	■	■	■		
Majestic Blue (296)	■	■			
Peridot (214)	■	■	■		
Rose Peach (262)	■	■	■		
Sapphire (206)	■	■	■		
Siam (208)	■	■	■		
Smoked Amber (1001)	■	■			
Tanzanite (539)	■	■	■		
Topaz (203)	■	■	■		
Rose Water Opal (395)	■	■			
White Opal (234)	■	■			

5601		Size	4 mm	6 mm	8 mm	10 mm	12 mm
<b>Crystal Effects</b>							
<b>Transparent Effects</b>							
	Crystal Aurore Boreale B (001 ABB)		■	■	■	■	
	Crystal Blue Shade B (001 BLSB)		■	■	■		
	Crystal Golden Shadow B (001 GSHAB)		■	■	■		
	Crystal Shimmer B (001 SHIMB)		■	■	■		
	Crystal Silver Night B (001 SINIB)		■	■	■		
	Crystal Vitrail Medium B (001 VMB)		■	■	■		
<b>Metallic Effects</b>							
	Crystal Light Chrome B (001 LTCHB)		■	■	■		
	Crystal Metallic Sunshine B (001 MTSHB)		■	■	■		
	Crystal Rose Gold B 2x (001 ROGB2)		■	■			
<b>Color Effects</b>							
<b>Transparent Effects</b>							
	Black Diamond Shimmer B (215 SHIMB)		■	■	■		
	Erinite Shimmer B (360 SHIMB)		■	■	■		
	Light Colorado Topaz Shimmer B (246 SHIMB)		■	■	■		
	Light Sapphire Shimmer B (211 SHIMB)		■	■	■		
	Light Siam Shimmer B (227 SHIMB)		■	■	■		
	Rose Water Opal Shimmer B (395 SHIMB)		■	■			
	White Opal Shimmer B (234 SHIMB)		■	■			

**5714 Star Bead**

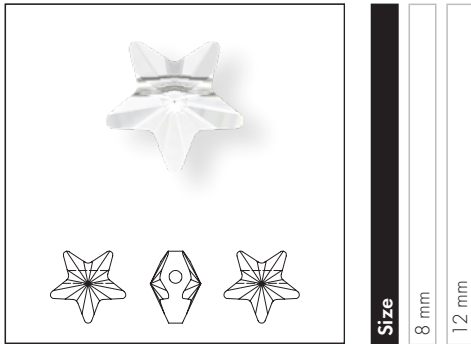

**Size**  
8 mm  
12 mm

**Crystal**

Crystal (001)

**Crystal Effects**

**Transparent Effects**

Crystal Aurore Boreale (001 AB)

**5741 Love Bead**

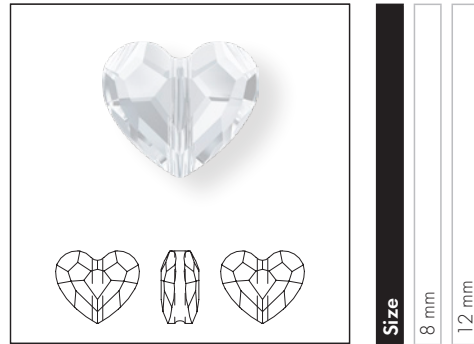

**Size**  
8 mm  
12 mm

**Crystal**

Crystal (001)

**Colors**

**Plain Colors**

Blush Rose (257)

Light Siam (227)

Rose (209)

**Crystal Effects**

**Transparent Effects**

Crystal Aurore Boreale (001 AB)

Crystal Silver Night 2x (001 SINI2)

**5742 Heart Bead**

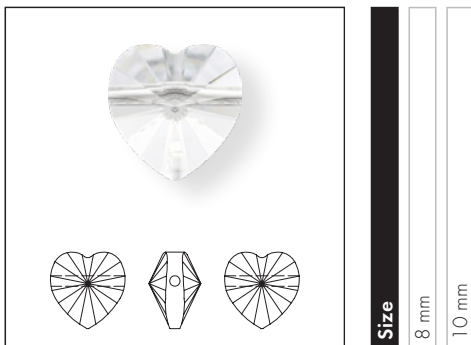

**Size**  
8 mm  
10 mm

**Crystal**

Crystal (001)

**Crystal Effects**

**Transparent Effects**

Crystal Aurore Boreale (001 AB)

**5750 Skull Bead**

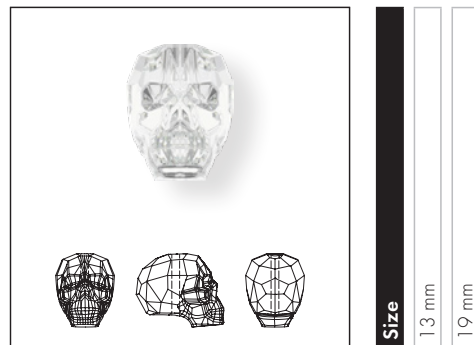

**Size**  
13 mm  
19 mm

**Crystal**

Crystal (001)

**Colors**

**Plain Colors**

Jet (280)

**Crystal Effects**

**Transparent Effects**

Crystal Paradise Shine (001 PARSH)

Crystal Silver Night (001 SINI)

Crystal Silver Night 2x (001 SINI2)

**Metallic Effects**

Crystal Metallic Light Gold 2x (001 MIG2)

5752 Clover Bead

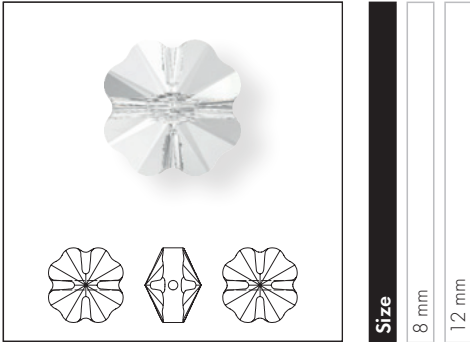

**Size**  
8 mm  
12 mm

<b>Crystal</b>		
Crystal (001)	■	■
<b>Colors</b>		
<b>Plain Colors</b>		
Fern Green (291)	■	■
<b>Crystal Effects</b>		
<b>Transparent Effects</b>		
Crystal Aurore Boreale (001 AB)	■	■
Crystal Golden Shadow (001 GSHA)	■	■

5754 Butterfly Bead

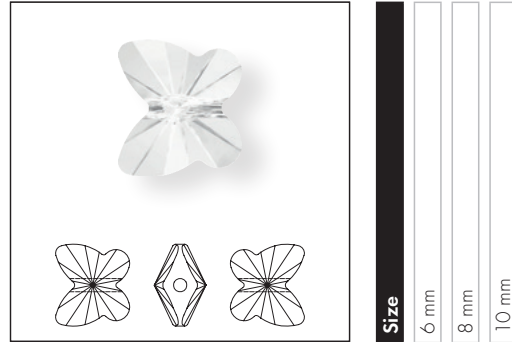

**Size**  
6 mm  
8 mm  
10 mm

<b>Crystal</b>			
Crystal (001)	■	■	■
<b>Colors</b>			
<b>Plain Colors</b>			
Fuchsia (502)	■	■	
Jet (280)	■	■	■
Light Rose (223)	■	■	■
Light Siam (227)	■	■	■
Violet (371)	■	■	
<b>Crystal Effects</b>			
<b>Transparent Effects</b>			
Crystal Aurore Boreale (001 AB)	■	■	■
Crystal Golden Shadow (001 GSHA)	■	■	■

# Product Details

Article Size	Packing Unit = Minimum Order Quantity in Pieces	Average Net Weight in Gram per Packing Unit Crystal (001)	Average Gross Weight in Gram per Packing Unit Crystal (001)
<b>5000</b>			
2 mm	1,440	11.5	20.8
3 mm	720	23.6	33.4
4 mm	720	53.5	62.6
5 mm	720	105.3	116.3
6 mm	360	81.6	92.5
8 mm	288	193.5	200.8
10 mm	144	180.6	199.4
12 mm	72	144.2	166.1
<b>5003</b>			
6 mm	360	109.9	120.8
8 mm	144	100.4	118.6
10 mm	144	195.9	219.2
12 mm	72	158.5	179.2
<b>5020</b>			
6 mm	360	74.5	85.2
8 mm	288	146.6	178.2
10 mm	144	116.4	139.2
<b>5028/4</b>			
6 mm	360	75.791	83.4
8 mm	144	74.714	85.6
10 mm	72	70.763	76.5
<b>5040</b>			
4 mm	720	41.3	50.4
6 mm	360	71.8	82.9
8 mm	288	135.6	163.7
12 mm	144	214.4	242.4
<b>5042</b>			
6 mm	288	45.7	69.3
8 mm	216	93.4	120.2
<b>5043</b>			
11 mm	12	13.2	31.8
<b>5044</b>			
5x4 mm	360	37.6	47.8
7x6 mm	288	98.1	108.3
9.5x8 mm	72	58.6	77.0
<b>5045</b>			
6 mm	288	60.7	70.9
8 mm	216	117.5	145.9
<b>5305</b>			
5 mm	720	52.7	63.9
6 mm	360	50.5	61.4

Article Size	Packing Unit = Minimum Order Quantity in Pieces	Average Net Weight in Gram per Packing Unit Crystal (001)	Average Gross Weight in Gram per Packing Unit Crystal (001)
<b>5328</b>			
2.5 mm	1,440	23.8	31.4
3 mm	1,440	34.1	45.2
4 mm	1,440	81.8	89.2
5 mm	720	89.3	100.0
6 mm	360	73.7	84.6
8 mm	288	141.8	173.4
10 mm	144	140.4	154.0
<b>5500</b>			
9x6 mm	144	59.0	69.9
12x8 mm	144	144.0	164.1
<b>5542</b>			
8 mm	96	81.4	102.9
<b>5601</b>			
4 mm	288	43.9	65.2
6 mm	144	70.6	88.9
8 mm	96	100.2	118.4
10 mm	72	138.0	156.5
12 mm	36	129.6	147.7
<b>5714</b>			
8 mm	288	73.3	102.1
12 mm	108	72.3	102.2
<b>5741</b>			
8 mm	144	43.3	66.24
12 mm	72	66.2	89.58
<b>5742</b>			
8 mm	288	120.5	154.5
10 mm	288	233.1	266.5
<b>5750</b>			
13 mm	12	24.2	43.8
19 mm	12	73.7	100.0
<b>5752</b>			
8 mm	288	106.1	136.9
12 mm	96	117.7	137.5
<b>5754</b>			
6 mm	360	42.3	53.0
8 mm	288	77.9	109.8
10 mm	288	156.9	188.9

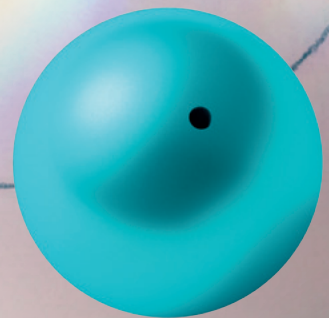
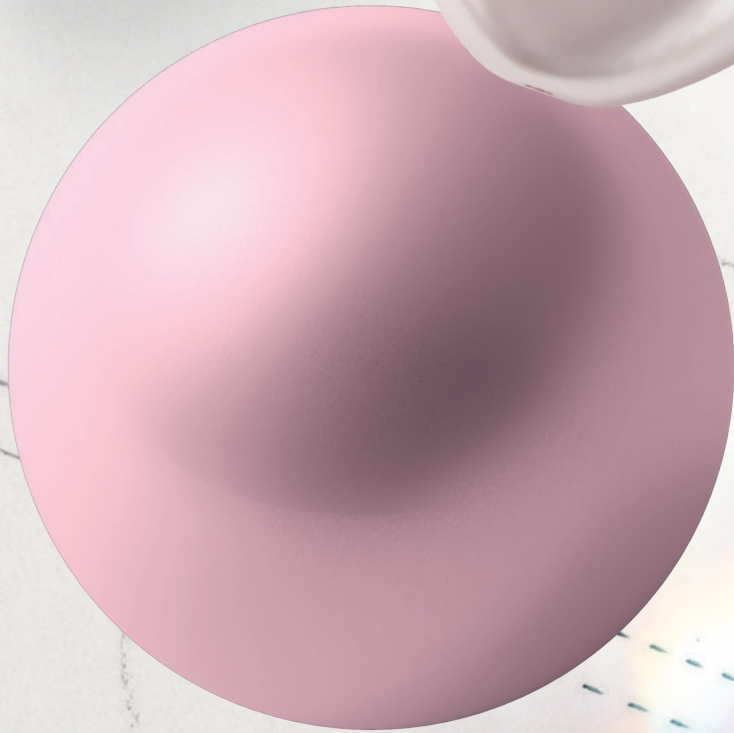





















# Crystal Pearls

Exquisite replicas of natural pearls, the shimmering luster of Crystal Pearls open up endless design possibilities. Either used alone or in combination with the vibrant Crystal Components collection, they bring grace and elegance to any design. A luxurious addition to jewelry, textiles, and even interior décor their soft sheen adapts to skin texture. Created from a distinctive core crafted from crystals, they are then enveloped with an innovative pearl coating to produce a flawless, silky smooth rounded surface.

Encompassing myriad hues, from timeless classics to contemporary iridescent shades in a range of shapes and sizes, our stunning assortment offers unparalleled perfection, and extreme versatility. With an extensive selection of hole options, various application methods are made possible for seamless design integration: Full Hole Pearl (5810 Crystal Round Pearl, 5821 Crystal Pear-Shaped Pearl, 5824 Crystal Rice Pearl, 5841–5844 Crystal Baroque Pearls, 5860 Crystal Coin Pearl), Half Hole Pearl (5817 Crystal Cabochon Pearl, 5818 Crystal Half Hole Pearl, ) and No Hole Pearl (5809 Crystal No Hole Pearl).

## Colors

-  Crystal White Pearl  
001 650
-  Crystal Light Creamrose Pearl  
001 618
-  Crystal Cream Pearl  
001 620
-  Crystal Creamrose Pearl  
001 621
-  Crystal Light Gold Pearl  
001 539
-  Crystal Gold Pearl  
001 296
-  Crystal Vintage Gold Pearl  
001 651
-  Crystal Bright Gold Pearl  
001 306
-  Crystal Copper Pearl  
001 159
-  Crystal Rose Gold Pearl  
001 769
-  Crystal Rose Peach Pearl  
001 674
-  Crystal Peach Pearl  
001 300
-  Crystal Rosaline Pearl  
001 294
-  Crystal Powder Rose Pearl  
001 352
-  Crystal Dark Coral Pearl  
001 196
-  Crystal Elderberry Pearl  
001 2019
-  Crystal Light Amethyst Pearl  
001 934

-  Crystal Lavender Pearl  
001 524
-  Crystal Light Blue Pearl  
001 302
-  Crystal Azore Pearl  
001 935
-  Crystal Petrol Pearl  
001 600
-  Crystal Powder Green Pearl  
001 393
-  Crystal Eden Green Pearl  
001 2014
-  Crystal Light Green Pearl  
001 293
-  Crystal Antique Brass Pearl  
001 402
-  Crystal Dark Green Pearl  
001 814
-  Crystal Brown Pearl  
001 815
-  Crystal Bronze Pearl  
001 295
-  Crystal Platinum Pearl  
001 459
-  Crystal Light Grey Pearl  
001 616
-  Crystal Grey Pearl  
001 731
-  Crystal Dark Grey Pearl  
001 617
-  Crystal Black Pearl  
001 298
-  Crystal Mystic Black Pearl  
001 335

## Iridescent Colors

-  Crystal Pearlescent White Pearl  
001 969
-  Crystal Iridescent Dreamy Rose Pearl  
001 2025
-  Crystal Iridescent Dove Grey Pearl  
001 954
-  Crystal Iridescent Dreamy Blue Pearl  
001 2026
-  Crystal Iridescent Light Blue Pearl  
001 948
-  Crystal Iridescent Dark Blue Pearl  
001 949
-  Crystal Iridescent Tahitian Look Pearl  
001 2004
-  Crystal Iridescent Green Pearl  
001 930
-  Crystal Iridescent Light Turquoise Pearl  
001 2028
-  Crystal Iridescent Dark Turquoise Pearl  
001 2029
-  Crystal Iridescent Rouge Pearl  
001 2027

## Numerical Order

001 159	Crystal Copper Pearl
001 196	Crystal Dark Coral Pearl
001 2004	Crystal Iridescent Tahitian Look Pearl
001 2014	Crystal Eden Green Pearl
001 2019	Crystal Elderberry Pearl
001 2025	Crystal Iridescent Dreamy Rose Pearl
001 2026	Crystal Iridescent Dreamy Blue Pearl
001 2027	Crystal Iridescent Rouge Pearl
001 2028	Crystal Iridescent Light Turquoise Pearl
001 2029	Crystal Iridescent Dark Turquoise Pearl
001 293	Crystal Light Green Pearl
001 294	Crystal Rosaline Pearl
001 295	Crystal Bronze Pearl
001 296	Crystal Gold Pearl
001 298	Crystal Black Pearl
001 300	Crystal Peach Pearl
001 302	Crystal Light Blue Pearl
001 306	Crystal Bright Gold Pearl
001 335	Crystal Mystic Black Pearl
001 352	Crystal Powder Rose Pearl
001 393	Crystal Powder Green Pearl
001 402	Crystal Antique Brass Pearl
001 459	Crystal Platinum Pearl
001 524	Crystal Lavender Pearl
001 539	Crystal Light Gold Pearl
001 600	Crystal Petrol Pearl
001 616	Crystal Light Grey Pearl
001 617	Crystal Dark Grey Pearl
001 618	Crystal Light Creamrose Pearl
001 620	Crystal Cream Pearl
001 621	Crystal Creamrose Pearl
001 650	Crystal White Pearl
001 651	Crystal Vintage Gold Pearl
001 674	Crystal Rose Peach Pearl
001 731	Crystal Grey Pearl
001 769	Crystal Rose Gold Pearl
001 814	Crystal Dark Green Pearl
001 815	Crystal Brown Pearl
001 930	Crystal Iridescent Green Pearl
001 934	Crystal Light Amethyst Pearl
001 935	Crystal Azore Pearl
001 948	Crystal Iridescent Light Blue Pearl
001 949	Crystal Iridescent Dark Blue Pearl
001 954	Crystal Iridescent Dove Grey Pearl
001 969	Crystal Pearlescent White Pearl

## Alphabetical Order

Crystal Antique Brass Pearl (001 402)
Crystal Azore Pearl (001 935)
Crystal Black Pearl (001 298)
Crystal Bright Gold Pearl (001 306)
Crystal Bronze Pearl (001 295)
Crystal Brown Pearl (001 815)
Crystal Copper Pearl (001 159)
Crystal Cream Pearl (001 620 )
Crystal Creamrose Pearl (001 621)
Crystal Dark Coral Pearl (001 196)
Crystal Dark Green Pearl (001 814)
Crystal Dark Grey Pearl (001 617)
Crystal Eden Green Pearl (001 2014)
Crystal Elderberry Pearl (001 2019)
Crystal Gold Pearl (001 296)
Crystal Grey Pearl (001 731)
Crystal Iridescent Dark Blue Pearl (001 949)
Crystal Iridescent Dark Turquoise Pearl (001 2029)
Crystal Iridescent Dove Grey Pearl (001 954)
Crystal Iridescent Dreamy Blue Pearl (001 2026)
Crystal Iridescent Dreamy Rose Pearl (001 2025)
Crystal Iridescent Green Pearl (001 930)
Crystal Iridescent Light Blue Pearl (001 948)
Crystal Iridescent Light Turquoise Pearl (001 2028)
Crystal Iridescent Rouge Pearl (001 2027)
Crystal Iridescent Tahitian Look Pearl (001 2004)
Crystal Lavender Pearl (001 524)
Crystal Light Amethyst Pearl (001 934)
Crystal Light Blue Pearl (001 302)
Crystal Light Creamrose Pearl (001 618)
Crystal Light Gold Pearl (001 539)
Crystal Light Green Pearl (001 293)
Crystal Light Grey Pearl (001 616 )
Crystal Mystic Black Pearl (001 335)
Crystal Peach Pearl (001 300)
Crystal Pearlescent White Pearl (001 969)
Crystal Petrol Pearl (001 600)
Crystal Platinum Pearl (001 459)
Crystal Powder Green Pearl (001 393)
Crystal Powder Rose Pearl (001 352)
Crystal Rosaline Pearl (001 294)
Crystal Rose Gold Pearl (001 769)
Crystal Rose Peach Pearl (001 674)
Crystal Vintage Gold Pearl (001 651)
Crystal White Pearl (001 650)

# Summary

1 2 3

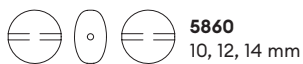
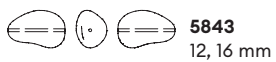
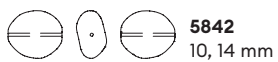
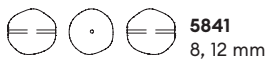
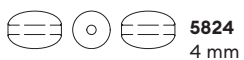
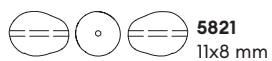

1 Top view 2 Side view 3 Back view

# Ordering Example & Product Variety Explanation

**5810** Crystal Round Pearl

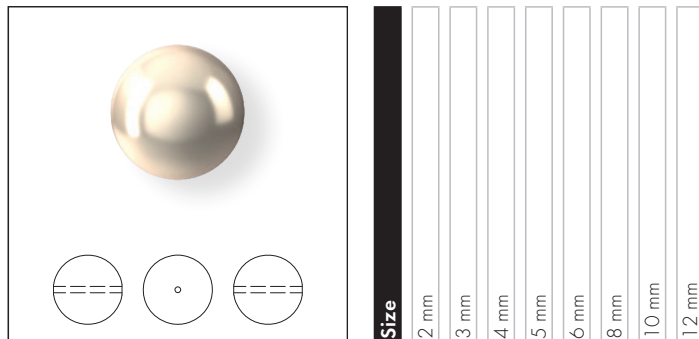

<b>5810</b>	<b>2 mm</b>	<b>001 650</b>
-------------	-------------	----------------

Article number	Crystal Pearl size All sizes are subject to special orders.	Color Desired Crystal Pearl color code Please see respective product matrix for all available reference codes.
----------------	--	--

07

**5809** Crystal No Hole Pearl

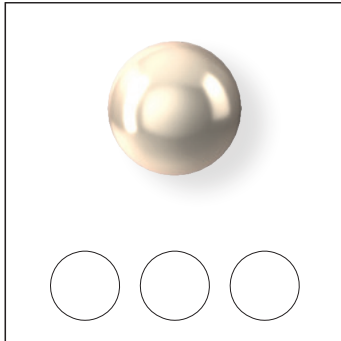

Size
1 mm
1.5 mm
2 mm
2.5 mm
3 mm
3.5 mm

**Pearl Colors**

Crystal Bright Gold Pearl (001 BGPRL)	■	■	■	■	■	■
Crystal Cream Pearl (001 CRM)	■	■	■	■	■	■
Crystal Creamrose Light Pearl (001 CRLT)	■	■	■	■	■	■
Crystal Creamrose Pearl (001 CRMR)	■	■	■	■	■	■
Crystal Gold Pearl (001 GOPRL)	■	■	■	■	■	■
Crystal Light Gold Pearl (001 LGPRL)	■	■	■	■	■	■
Crystal Rose Gold Pearl (001 RGPRL)	■	■	■	■	■	■
Crystal White Pearl (001 WHITE)	■	■	■	■	■	■

5810 Crystal Round Pearl

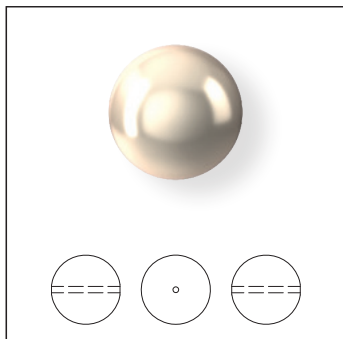

Size	2 mm	3 mm	4 mm	5 mm	6 mm	8 mm	10 mm	12 mm
------	------	------	------	------	------	------	-------	-------

Pearl Colors

Crystal Antique Brass Pearl (001 ABPRL)	■	■	■	■	■	■	■	■
Crystal Azore Pearl (001 AZPRL)	■	■	■	■	■	■	■	■
Crystal Black Pearl (001 BLPRL)	■	■	■	■	■	■	■	■
Crystal Bright Gold Pearl (001 BGPRL)	■	■	■	■	■	■	■	■
Crystal Bronze Pearl (001 BRPRL)	■	■	■	■	■	■	■	■
Crystal Brown Pearl (001 BWPRL)	■	■	■	■	■	■	■	■
Crystal Copper Pearl (001 COPRL)	■	■	■	■	■	■	■	■
Crystal Cream Pearl (001 CRM)	■	■	■	■	■	■	■	■
Crystal Creamrose Light Pearl (001 CRTI)	■	■	■	■	■	■	■	■
Crystal Creamrose Pearl (001 CRMR)	■	■	■	■	■	■	■	■
Crystal Dark Coral Pearl (001 DCPRL)	■	■	■	■	■	■	■	■
Crystal Dark Green Pearl (001 DGPRL)	■	■	■	■	■	■	■	■
Crystal Dark Grey Pearl (001 DGREY)	■	■	■	■	■	■	■	■
Crystal Eden Green Pearl (001 EDGRP)	■	■	■	■	■	■	■	■
Crystal Elderberry Pearl (001 ELBEP)	■	■	■	■	■	■	■	■
Crystal Gold Pearl (001 GOPRL)	■	■	■	■	■	■	■	■
Crystal Grey Pearl (001 GRPRL)	■	■	■	■	■	■	■	■
Crystal Lavender Pearl (001 LAPRL)	■	■	■	■	■	■	■	■
Crystal Light Amethyst Pearl (001 LTAMP)	■	■	■	■	■	■	■	■
Crystal Light Blue Pearl (001 LTBLP)	■	■	■	■	■	■	■	■
Crystal Light Gold Pearl (001 LGPRL)	■	■	■	■	■	■	■	■
Crystal Light Green Pearl (001 LTGRP)	■	■	■	■	■	■	■	■
Crystal Light Grey Pearl (001 LGREY)	■	■	■	■	■	■	■	■
Crystal Peach Pearl (001 PEPRL)	■	■	■	■	■	■	■	■
Crystal Petrol Pearl (001 PLPRL)	■	■	■	■	■	■	■	■
Crystal Platinum Pearl (001 PTPRL)	■	■	■	■	■	■	■	■
Crystal Powder Green Pearl (001 PGPRL)	■	■	■	■	■	■	■	■
Crystal Powder Rose Pearl (001 PRPRL)	■	■	■	■	■	■	■	■
Crystal Rosaline Pearl (001 ROPRL)	■	■	■	■	■	■	■	■
Crystal Rose Gold Pearl (001 RGPRL)	■	■	■	■	■	■	■	■
Crystal Rose Peach Pearl (001 ROPEP)	■	■	■	■	■	■	■	■
Crystal Vintage Gold Pearl (001 VGPRL)	■	■	■	■	■	■	■	■
Crystal White Pearl (001 WHITE)	■	■	■	■	■	■	■	■

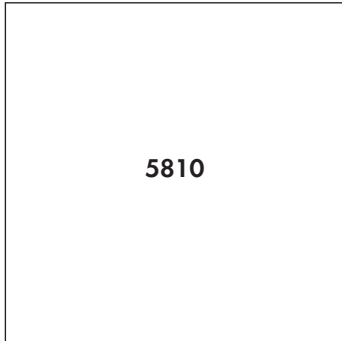

5810

Size	2 mm	3 mm	4 mm	5 mm	6 mm	8 mm	10 mm	12 mm
------	------	------	------	------	------	------	-------	-------

**Pearl Gemcolors**

● Crystal Mystic Black Pearl (001 MBPRL)

**Iridescent Pearl Colors**

● Crystal Iridescent Dark Blue Pearl (001 IDBLP)

● Crystal Iridescent Dark Turquoise Pearl (001 IDTUP)

● Crystal Iridescent Dove Grey Pearl (001 IDGYP)

● Crystal Iridescent Dreamy Blue (001 IDRBP)

● Crystal Iridescent Dreamy Rose (001 IDROP)

● Crystal Iridescent Green Pearl (001 IGPRL)

● Crystal Iridescent Light Blue Pearl (001 ILBLP)

● Crystal Iridescent Light Turquoise Pearl (001 ILTUP)

● Crystal Iridescent Rouge Pearl (001 ROUGP)

● Crystal Iridescent Tahitian Look Pearl (001 IRTLP)

● Crystal Pearlescent White Pearl (001 PEWHP)

● Crystal Mystic Black Pearl (001 MBPRL)	■	■	■	■	■	■	■	■
● Crystal Iridescent Dark Blue Pearl (001 IDBLP)	■	■	■	■	■	■	■	■
● Crystal Iridescent Dark Turquoise Pearl (001 IDTUP)	■	■	■	■	■	■	■	■
● Crystal Iridescent Dove Grey Pearl (001 IDGYP)	■	■	■	■	■	■	■	■
● Crystal Iridescent Dreamy Blue (001 IDRBP)	■	■	■	■	■	■	■	■
● Crystal Iridescent Dreamy Rose (001 IDROP)	■	■	■	■	■	■	■	■
● Crystal Iridescent Green Pearl (001 IGPRL)	■	■	■	■	■	■	■	■
● Crystal Iridescent Light Blue Pearl (001 ILBLP)	■	■	■	■	■	■	■	■
● Crystal Iridescent Light Turquoise Pearl (001 ILTUP)	■	■	■	■	■	■	■	■
● Crystal Iridescent Rouge Pearl (001 ROUGP)	■	■	■	■	■	■	■	■
● Crystal Iridescent Tahitian Look Pearl (001 IRTLP)	■	■	■	■	■	■	■	■
● Crystal Pearlescent White Pearl (001 PEWHP)	■	■	■	■	■	■	■	■



5817 Crystal Cabochon Pearl

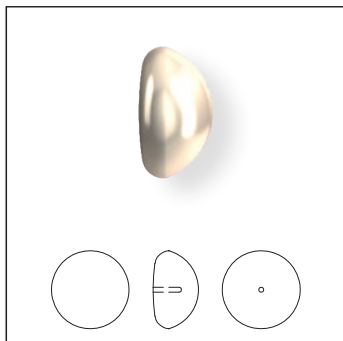

Size	6 mm	8 mm	10 mm
------	------	------	-------

**Pearl Colors**

Crystal Bronze Pearl (001 BRPRL)	■	■	■
Crystal Cream Pearl (001 CRM)	■	■	■
Crystal Creamrose Light Pearl (001 CRLT)	■	■	■
Crystal Creamrose Pearl (001 CRMRL)	■	■	■
Crystal Dark Grey Pearl (001 DGREY)	■	■	■
Crystal Light Grey Pearl (001 LGREY)	■	■	■
Crystal Peach Pearl (001 PEPRL)	■	■	■
Crystal Rosaline Pearl (001 ROPRL)	■	■	■
Crystal Rose Gold Pearl (001 RGPRL)	■	■	■
Crystal White Pearl (001 WHITE)	■	■	■

**Pearl Gemcolors**

Crystal Mystic Black Pearl (001 MBPRL)	■	■	■
--	---	---	---

**Iridescent Pearl Colors**

Crystal Iridescent Dark Blue Pearl (001 IDBLP)	■	■	■
Crystal Iridescent Dark Turquoise Pearl (001 IDTUP)	■	■	■
Crystal Iridescent Dove Grey Pearl (001 IDGYP)	■	■	■
Crystal Iridescent Dreamy Blue Pearl (001 IDRBP)	■	■	■
Crystal Iridescent Dreamy Rose Pearl (001 IDROP)	■	■	■
Crystal Iridescent Green Pearl (001 IGPRL)	■	■	■
Crystal Iridescent Light Blue Pearl (001 ILBLP)	■	■	■
Crystal Iridescent Light Turquoise Pearl (001 ILTUP)	■	■	■
Crystal Iridescent Rouge Pearl (001 ROUGP)	■	■	■
Crystal Iridescent Tahitian Look Pearl (001 IRTLP)	■	■	■
Crystal Pearlescent White Pearl (001 PEWHP)	■	■	■

**5818** Crystal Half Hole Pearl

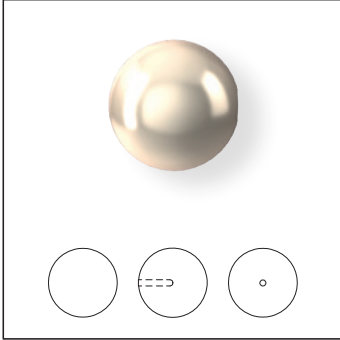

Size	3 mm	4 mm	5 mm	6 mm	8 mm	10 mm	12 mm
------	------	------	------	------	------	-------	-------

**Pearl Colors**

Crystal Black Pearl (001 BLPRL)	■	■	■	■	■	■	■
Crystal Bright Gold Pearl (001 BGPRL)	■	■	■	■	■	■	■
Crystal Cream Pearl (001 CRM)	■	■	■	■	■	■	■
Crystal Creamrose Light Pearl (001 CRLT)	■	■	■	■	■	■	■
Crystal Creamrose Pearl (001 CRMR)	■	■	■	■	■	■	■
Crystal Dark Grey Pearl (001 DGREY)	■	■	■	■	■	■	■
Crystal Gold Pearl (001 GOPRL)	■	■	■	■	■	■	■
Crystal Grey Pearl (001 GRPRL)	■	■	■	■	■	■	■
Crystal Lavender Pearl (001 LAPRL)	■	■	■	■	■	■	■
Crystal Light Gold Pearl (001 LGPRL)	■	■	■	■	■	■	■
Crystal Light Grey Pearl (001 LGREY)	■	■	■	■	■	■	■
Crystal Peach Pearl (001 PEPRL)	■	■	■	■	■	■	■
Crystal Rosaline Pearl (001 ROPRL)	■	■	■	■	■	■	■
Crystal Rose Gold Pearl (001 RGPRL)	■	■	■	■	■	■	■
Crystal White Pearl (001 WHITE)	■	■	■	■	■	■	■

**Pearl Gemcolors**

Crystal Mystic Black Pearl (001 MBPRL)	■	■	■	■	■	■	■
--	---	---	---	---	---	---	---

**Iridescent Pearl Colors**

Crystal Iridescent Dark Blue Pearl (001 IDBLP)	■	■	■	■	■	■	■
Crystal Iridescent Dark Turquoise Pearl (001 IDTUP)	■	■	■	■	■	■	■
Crystal Iridescent Dove Grey Pearl (001 IDGYP)	■	■	■	■	■	■	■
Crystal Iridescent Light Blue Pearl (001 ILBLP)	■	■	■	■	■	■	■
Crystal Iridescent Light Turquoise Pearl (001 ILTUP)	■	■	■	■	■	■	■
Crystal Iridescent Rouge Pearl (001 ROUGP)	■	■	■	■	■	■	■
Crystal Pearlescent White Pearl (001 PEWHP)	■	■	■	■	■	■	■

**5821** Crystal Pear-shaped Pearl

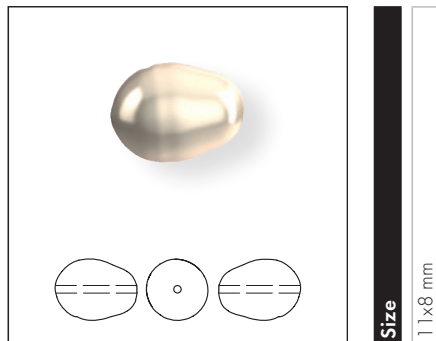

**Size**  
11x8 mm

**Pearl Colors**

- Crystal Cream Pearl (001 CRM)
- Crystal Creamrose Light Pearl (001 CRLT)
- Crystal Creamrose Pearl (001 CRMR)
- Crystal Light Grey Pearl (001 LGREY)
- Crystal Rosaline Pearl (001 ROPRL)
- Crystal White Pearl (001 WHITE)

**Iridescent Pearl Colors**

- Crystal Iridescent Green Pearl (001 IGPRL)

**5824** Crystal Rice Shape Pearl

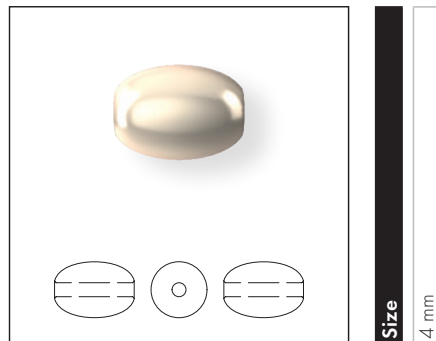

**Size**  
4 mm

**Pearl Colors**

- Crystal Cream Pearl (001 CRM)
- Crystal Creamrose Light Pearl (001 CRLT)
- Crystal Creamrose Pearl (001 CRMR)
- Crystal Gold Pearl (001 GOPRL)
- Crystal Light Gold Pearl (001 IGPRL)
- Crystal Rosaline Pearl (001 ROPRL)
- Crystal White Pearl (001 WHITE)

**Iridescent Pearl Colors**

- Crystal Iridescent Dark Turquoise Pearl (001 IDTUP)
- Crystal Iridescent Light Turquoise Pearl (001 IITUP)

**5841** Crystal Baroque Round Pearl

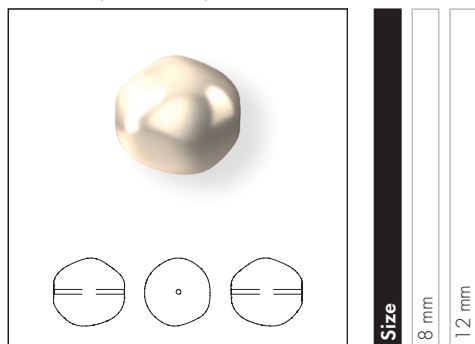

**Size**  
8 mm  
12 mm

**Pearl Colors**

- Crystal Cream Pearl (001 CRM)
- Crystal Creamrose Light Pearl (001 CRLT)
- Crystal Creamrose Pearl (001 CRMR)
- Crystal Dark Grey Pearl (001 DGREY)
- Crystal Rosaline Pearl (001 ROPRL)
- Crystal White Pearl (001 WHITE)

**5842** Crystal Baroque Coin Pearl

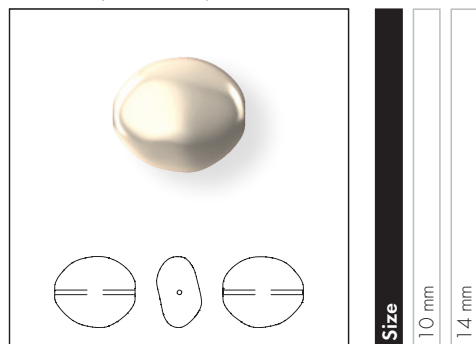

**Size**  
10 mm  
14 mm

**Pearl Colors**

- Crystal Cream Pearl (001 CRM)
- Crystal Creamrose Light Pearl (001 CRLT)
- Crystal Creamrose Pearl (001 CRMR)
- Crystal Dark Grey Pearl (001 DGREY)
- Crystal Rosaline Pearl (001 ROPRL)
- Crystal White Pearl (001 WHITE)

**5843** Crystal Baroque Drop Pearl

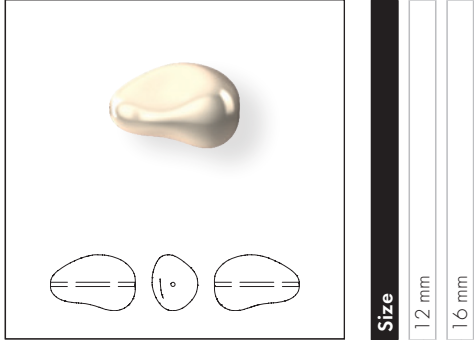

**Size**  
12 mm  
16 mm

**Pearl Colors**

- Crystal Cream Pearl (001 CRM)
- Crystal Creamrose Light Pearl (001 CRLT)
- Crystal Creamrose Pearl (001 CRMR)
- Crystal Dark Grey Pearl (001 DGREY)
- Crystal Rosaline Pearl (001 ROPRL)
- Crystal White Pearl (001 WHITE)

**5844** Crystal Baroque Elongated Pearl

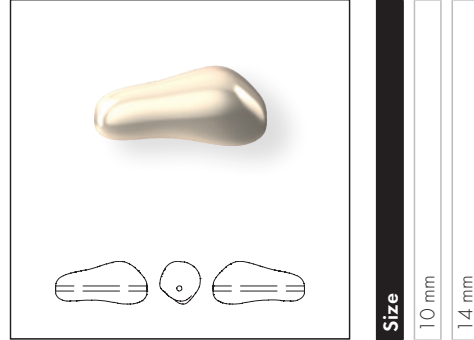

**Size**  
10 mm  
14 mm

**Pearl Colors**

- Crystal Cream Pearl (001 CRM)
- Crystal Creamrose Light Pearl (001 CRLT)
- Crystal Creamrose Pearl (001 CRMR)
- Crystal Dark Grey Pearl (001 DGREY)
- Crystal Rosaline Pearl (001 ROPRL)
- Crystal White Pearl (001 WHITE)

**5860** Crystal Coin Pearl

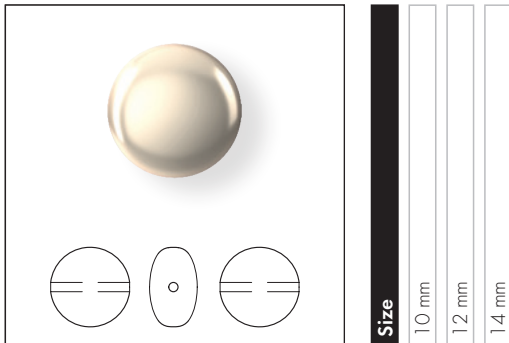

**Size**  
10 mm  
12 mm  
14 mm

**Pearl Colors**

- Crystal Cream Pearl (001 CRM)
- Crystal White Pearl (001 WHITE)

# Product Details

Article Size	Packing Unit = Minimum Order Quantity in Pieces	Average Net Weight in Gram per Packing Unit Crystal (001)	Average Gross Weight in Gram per Packing Unit Crystal (001)
<b>5809</b>			
1 mm	3,000	4.3	14.8
1.5 mm	2,000	8.5	18.8
2 mm	1,500	20.4	30.4
2.5 mm	1,000	23.9	34.4
3 mm	1,000	36.6	46.4
3.5 mm	1,000	60.3	70.9
<b>5810</b>			
2 mm	1,000	10.2	23.3
3 mm	1,000	38.5	53.5
4 mm	500	38.1	53.6
5 mm	500	83.7	99.2
6 mm	500	142.3	157.8
8 mm	250	173.7	188.9
10 mm	100	110.5	123.9
12 mm	100	191.7	205.1
<b>5817</b>			
6 mm	250	35.8	49.3
8 mm	250	97.9	111.2
10 mm	250	195.6	203.9
<b>5818</b>			
3 mm	1,000	42.0	52.0
4 mm	500	41.9	55.4
5 mm	500	87.9	101.4
6 mm	500	146.5	160.0
8 mm	250	177.9	191.1
10 mm	100	112.2	125.6
12 mm	100	187.5	200.9
<b>5821</b>			
11x8 mm	250	242.5	253.0
<b>5824</b>			
4 mm	500	28.0	42.0
<b>5841</b>			
8 mm	250	164.5	178.5
12 mm	100	210.8	224.8
<b>5842</b>			
10 mm	250	164.5	178.5
14 mm	100	182.9	196.9
<b>5843</b>			
12 mm	250	195.8	209.8
16 mm	100	179.7	193.6
<b>5844</b>			
10 mm	250	87.3	101.3
14 mm	100	80.8	94.8
<b>5860</b>			
10 mm	100	91.5	103.5
12 mm	100	155.6	167.6
14 mm	50	123.0	135.0

# Pendants

Exuding timeless elegance, available in a large range of classic, and avant-garde cuts and shapes, Pendants are offered in a captivating variety of colors and effects. Unlocking multiple design arenas with their easy application – the top hole requires only a jump ring or pinch bail with a chain or cord – the diverse size range ensures Pendants are perfect for jewelry sets, as well as apparel, and accessories.























## Colors & Effects

OPEN TO SEE COLORS & EFFECTS











## Colors

 Crystal 001	 Majestic Blue 296
 Light Rose 223	 Montana 207
 Rose Peach 262	 Denim Blue 266
 Padparadscha 542	 Light Turquoise 263
 Rose 209	 Blue Zircon 229
 Fuchsia 502	 Erinite 360
 Light Siam 227	 Peridot 214
 Scarlet 276	 Citrus Green 337
 Siam 208	 Fern Green 291
 Ruby 501	 Emerald 205
 Amethyst 204	 Jonquil 213
 Iris 219	 Light Topaz 226
 Light Amethyst 212	 Golden Topaz 1003
 Violet 371	 Light Colorado Topaz 246
 Tanzanite 539	 Topaz 203
 Aquamarine 202	 Light Amber 1002
 Light Sapphire 211	 Smoked Amber 1001
 Sapphire 206	 Jet 280
 Capri Blue 243	









## Effects

 Crystal Moonlight 001 MOL
 Crystal Shimmer 001 SHIM
 Crystal Aurore Boreale 001 AB
 Crystal Antique Pink 001 ANTP
 Crystal Vitrail Light 001 VL
 Crystal Paradise Shine 001 PARSH
 Crystal Vitrail Medium 001 VM
 Crystal Heliotrope 001 HEL
 Crystal Bermuda Blue 001 BBL
 Crystal Blue Shade 001 BLSH
 Crystal Golden Shadow 001 GSHA
 Crystal Light Chrome 001 LTCH
 Crystal Silver Shade 001 SSHA
 Crystal Silver Night 001 SINI

## AB Effects

 Light Rose Aurore Boreale 223 AB
 Rose Aurore Boreale 209 AB
 Fuchsia Aurore Boreale 502 AB
 Light Siam Aurore Boreale 227 AB
 Siam Aurore Boreale 208 AB
 Violet Aurore Boreale 371 AB
 Aquamarine Aurore Boreale 202 AB
 Sapphire Aurore Boreale 206 AB
 Blue Zircon Aurore Boreale 229 AB
 Peridot Aurore Boreale 214 AB
 Light Topaz Aurore Boreale 226 AB

## Shimmer Effects

 Light Rose Shimmer 223 SHIM
 Light Siam Shimmer 227 SHIM
 Amethyst Shimmer 204 SHIM
 Light Amethyst Shimmer 212 SHIM
 Aquamarine Shimmer 202 SHIM
 Light Sapphire Shimmer 211 SHIM
 Emerald Shimmer 205 SHIM
 Light Topaz Shimmer 226 SHIM
 Light Colorado Topaz Shimmer 246 SHIM

## Numerical Order

001	Crystal	206	Sapphire	229	Blue Zircon
001 AB	Crystal Aurore Boreale	207	Montana	243	Capri Blue
001 ANTP	Crystal Antique Pink	208 AB	Siam Aurore Boreale	246 SHIM	Light Colorado Topaz Shimmer
001 BBL	Crystal Bermuda Blue	208	Siam	246	Light Colorado Topaz
001 BLSH	Crystal Blue Shade	209 AB	Rose Aurore Boreale	262	Rose Peach
001 GSHA	Crystal Golden Shadow	209	Rose	263	Light Turquoise
001 HEL	Crystal Heliotrope	211 SHIM	Light Sapphire Shimmer	266	Denim Blue
001 LTCH	Crystal Light Chrome	211	Light Sapphire	276	Scarlet
001 MOL	Crystal Moonlight	212 SHIM	Light Amethyst Shimmer	280	Jet
001 PARSH	Crystal Paradise Shine	212	Light Amethyst	291	Fern Green
001 SHIM	Crystal Shimmer	213	Jonquil	296	Majestic Blue
001 SINI	Crystal Silver Night	214 AB	Peridot Aurore Boreale	337	Citrus Green
001 SSHA	Crystal Silver Shade	214	Peridot	360	Erinite
001 VL	Crystal Vitrail Light	219	Iris	371 AB	Violet Aurore Boreale
001 VM	Crystal Vitrail Medium	223 AB	Light Rose Aurore Boreale	371	Violet
202 AB	Aquamarine Aurore Boreale	223 SHIM	Light Rose Shimmer	501	Ruby
202 SHIM	Aquamarine Shimmer	223	Light Rose	502 AB	Fuchsia Aurore Boreale
202	Aquamarine	226 AB	Light Topaz Aurore Boreale	502	Fuchsia
203	Topaz	226 SHIM	Light Topaz Shimmer	539	Tanzanite
204	Amethyst	226	Light Topaz	542	Padparadscha
204 SHIM	Amethyst Shimmer	227 AB	Light Siam Aurore Boreale	1001	Smoked Amber
205 SHIM	Emerald Shimmer	227 SHIM	Light Siam Shimmer	1002	Light Amber
205	Emerald	227	Light Siam	1003	Golden Topaz
206 AB	Sapphire Aurore Boreale	229 AB	Blue Zircon Aurore Boreale		

## Alphabetical Order

Amethyst (204)	Denim Blue (266)	Light Topaz (226)
Amethyst Shimmer (204 SHIM)	Emerald (205)	Light Topaz Aurore Boreale (226 AB)
Aquamarine (202)	Emerald Shimmer (205 SHIM)	Light Topaz Shimmer (226 SHIM)
Aquamarine Aurore Boreale (202 AB)	Erinite (360)	Light Turquoise (263)
Aquamarine Shimmer (202 SHIM)	Fern Green (291)	Majestic Blue (296)
Blue Zircon (229)	Fuchsia (502)	Montana (207)
Blue Zircon Aurore Boreale (229 AB)	Fuchsia Aurore Boreale (502 AB)	Padparadscha (542)
Capri Blue (243)	Golden Topaz (1003)	Peridot (214)
Citrus Green (337)	Iris (219)	Peridot Aurore Boreale (214 AB)
Crystal (001)	Jet (280)	Rose (209)
Crystal Antique Pink (001 ANTP)	Jonquil (213)	Rose Aurore Boreale (209 AB)
Crystal Aurore Boreale (001 AB)	Light Amber (1002)	Rose Peach (262)
Crystal Bermuda Blue (001 BBL)	Light Amethyst (212)	Ruby (501)
Crystal Blue Shade (001 BLSH)	Light Amethyst Shimmer (212 SHIM)	Sapphire (206)
Crystal Golden Shadow (001 GSHA)	Light Colorado Topaz (246)	Sapphire Aurore Boreale (206 AB)
Crystal Heliotrope (001 HEL)	Light Colorado Topaz Shimmer (246 SHIM)	Scarlet (276)
Crystal Light Chrome (001 LTCH)	Light Rose (223)	Siam (208)
Crystal Moonlight (001 MOL)	Light Rose Aurore Boreale (223 AB)	Siam Aurore Boreale (208 AB)
Crystal Paradise Shine (001 PARSH)	Light Rose Shimmer (223 SHIM)	Smoked Amber (1001)
Crystal Shimmer (001 SHIM)	Light Sapphire (211)	Tanzanite (539)
Crystal Silver Night (001 SINI)	Light Sapphire Shimmer (211 SHIM)	Topaz (203)
Crystal Silver Shade (001 SSHA)	Light Siam (227)	Violet (371)
Crystal Vitrail Light (001 VL)	Light Siam Aurore Boreale (227 AB)	Violet Aurore Boreale (371 AB)
Crystal Vitrail Medium (001 VM)	Light Siam Shimmer (227 SHIM)	

For details on available colors and effects for each article within the product groups, please see the product matrix of the respective item in the Collection 2023.













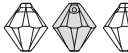

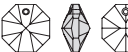

















The plating resistance of effects is tested according to Swarovski's plating guidelines (SWAROVSKI.COM/S-PROFESSIONALS). Customers are advised to carry out their own tests if their plating parameters diverge from Swarovski plating guidelines.

Colors and effects can appear different when illuminated with different light sources. Swarovski uses standard light source D65 for color decision and comparison. Slight changes in shades are unavoidable. Colors may vary according to cut and foiling.

The composition of Advanced Crystal is compliant with regulatory industry norms and laws regarding the restriction or prohibition of certain substances in the most relevant segments of our customers. Please note that the compliance of the colors Light Siam and Siam varies according to certain industry regulations. Those regulations are indicated with \* in the compliance overview. Indian Siam, Ruby and Scarlet (option to Lt. Siam) conform to all CLEAR-lists. For further information please visit [swarovski.com/s-professionals](http://swarovski.com/s-professionals)

© 2023 D. Swarovski Distribution GmbH

# Summary

1 2 3  <b>6000</b> 11x5.5, 13x6.5, 15x7.5, 22x11 mm	1 2 3  <b>6090</b> 16x11, 22x15 mm	1 2 3  <b>6328</b> 6, 8 mm
 <b>6002</b> 10x7, 15x11.5 mm	 <b>6100</b> 24x12 mm	 <b>6401</b> 8 mm
 <b>6007</b> 7x4, 9x5 mm	 <b>6106</b> 16, 22, 28, 38 mm	 <b>6428</b> 6, 8, 12 mm
 <b>6010</b> 11x5.5, 13x6.5, 17x8.5, 21x10.5 mm	 <b>6128</b> 8, 10, 12 mm	 <b>6430</b> 8, 10, 14 mm
 <b>6015</b> 17, 21 mm	 <b>6210</b> 12, 17 mm	 <b>6431</b> 9, 11.5, 16 mm
 <b>6017/G</b> 30, 56 mm	 <b>6215</b> 18 mm	 <b>6432</b> 8, 10.5, 14.5 mm
 <b>6020</b> 18, 30, 37 mm	 <b>6225</b> 10, 18, 28 mm	 <b>6433</b> 9, 11.5, 16 mm
 <b>6022</b> 14, 24 mm	 <b>6228</b> 10.3x10, 14.4x14, 18x17.5, 28, 40 mm	 <b>6434</b> 8, 10.5, 14.5 mm
 <b>6028</b> 8, 10, 12, 18 mm	 <b>6240</b> 12, 17, 27 mm	 <b>6435</b> 9, 11.5, 16 mm
 <b>6040</b> 20, 30, 40 mm	 <b>6261</b> 17, 27 mm	 <b>6436</b> 9, 11.5, 16 mm
 <b>6049</b> 20, 30 mm	 <b>6264</b> 18, 28 mm	 <b>6438</b> 9, 11.5, 16 mm

1 Front view 2 Side view 3 Back view

"1 Front view" or "3 Back view" shaded in gray: surface effect is applied to this side.

"2 Side view" shaded in gray: side of surface effect not defined (for all symmetrical and some asymmetrical articles).

Where all views are shaded in gray, the effect is applied over the entire marked surface.

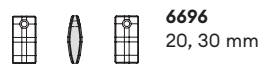
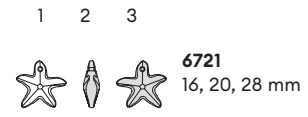
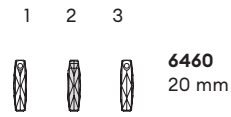

1 Front view 2 Side view 3 Back view

"1 Front view" or "3 Back view" shaded in gray: the surface effect is applied to this side.

"2 Side view" shaded in gray: side of surface effect not defined (for all symmetrical and some asymmetrical articles).

6721: 16, 20 mm: no defined side for surface effect; 28, 40 mm surface effect on "3 Back view."

6864: Reverse effect "V" is the standard version and is therefore shaded.

6000 Classic Drop Pendant

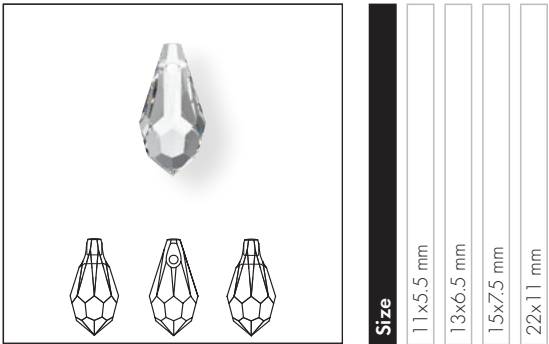

**Size**  
 11x5.5 mm  
 13x6.5 mm  
 15x7.5 mm  
 22x11 mm

Crystal	
Crystal (001)	■ ■ ■ ■
Colors	
Plain Colors	
Amethyst (204)	■
Aquamarine (202)	■
Blue Zircon (229)	■
Emerald (205)	■
Jet (280)	■ ■ ■
Light Amethyst (212)	■
Light Siam (227)	■
Majestic Blue (296)	■
Peridot (214)	■
Rose (209)	■
Sapphire (206)	■
Scarlet (276)	■
Siam (208)	■ ■ ■
Tanzanite (539)	■
Topaz (203)	■
Crystal Effects	
Transparent Effects	
Crystal Aurore Boreale (001 AB)	■ ■ ■ ■
Crystal Paradise Shine (001 PARSH)	■

6002 Oval Disco Pendant

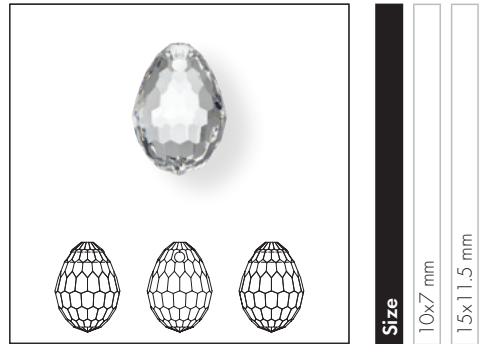

**Size**  
 10x7 mm  
 15x11.5 mm

Crystal	
Crystal (001)	■ ■
Crystal Effects	
Transparent Effects	
Crystal Aurore Boreale (001 AB)	■ ■

08

6007 Small Briolette Pendant



**Size**  
 7x4 mm  
 9x5 mm

Crystal	
Crystal (001)	■ ■
Crystal Effects	
Transparent Effects	
Crystal Aurore Boreale (001 AB)	■ ■
Crystal Golden Shadow (001 GSHA)	■ ■

**6010** Briolette Pendant



**Size** 11x5.5, 13x6.5, 17x8.5, 21x10.5 mm

**6106** Pear-shaped Pendant

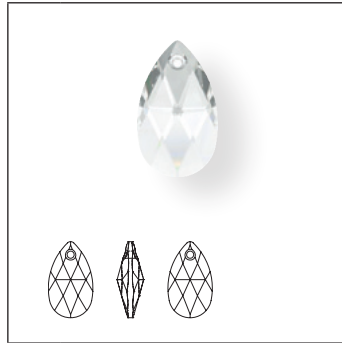

**Size** 16, 22, 28, 38 mm

**6228** XILION Heart Pendant

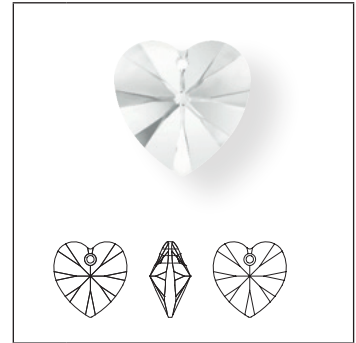

**Size** 10.3x10, 14.4x14, 18x17.5, 28 mm

**6428** XILION Pendant

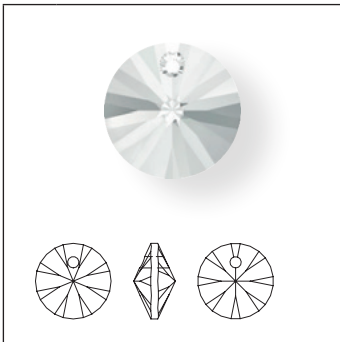

**Size** 6 mm

**6428** XILION Pendant

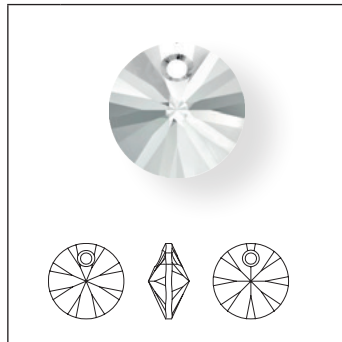

**Size** 8, 12 mm

	<b>6010 Briolette Pendant</b>				<b>6106 Pear-shaped Pendant</b>				<b>6228 XILION Heart Pendant</b>				<b>6428 XILION Pendant</b>			
	11x5.5 mm	13x6.5 mm	17x8.5 mm	21x10.5 mm	16 mm	22 mm	28 mm	38 mm	10.3x10 mm	14.4x14 mm	18x17.5 mm	28 mm	40 mm	6 mm	8 mm	12 mm
<b>Crystal</b>																
Crystal (001)	■	■	■	■	■	■	■	■	■	■	■	■	■	■	■	■
<b>Colors</b>																
<b>Plain Colors</b>																
Amethyst (204)	■	■	■		■	■	■		■	■	■			■	■	■
Aquamarine (202)	■	■	■		■	■	■		■	■	■			■	■	■
Blue Zircon (229)	■	■			■	■			■	■				■	■	
Denim Blue (266)	■	■														
Citrus Green (337)																
Emerald (205)	■	■	■		■	■	■		■	■	■			■	■	■

\* All colors with a 4-digit color code (i.e. Golden Topaz) are fully customizable with shorter lead times and lower MOQs compared to our 3-digit colors. Please get in touch with the Customer Service for a time and quantity estimation of your desired variant.



<b>6010</b> <b>6106</b> <b>6228</b> <b>6428</b>		Size	6010 Briolette Pendant				6106 Pear-shaped Pendant				6228 XILION Heart Pendant				6428 XILION Pendant			
			11x5.5 mm	13x6.5 mm	17x8.5 mm	21x10.5 mm	16 mm	22 mm	28 mm	38 mm	10.3x10 mm	14.4x14 mm	18x17.5 mm	28 mm	40 mm	6 mm	8 mm	12 mm
Erinite (360)			■	■														
Fern Green (291)			■	■														
Fuchsia (502)			■	■							■	■						
Golden Topaz (1003)*			■	■			■	■			■	■				■	■	
Iris (219)			■	■												■	■	■
Jet (280)			■	■			■	■	■							■	■	■
Light Amethyst (212)			■	■			■	■			■	■	■			■	■	
Light Colorado Topaz (246)			■	■			■	■	■							■	■	■
Light Rose (223)			■	■	■		■	■	■		■	■	■			■	■	■
Light Sapphire (211)							■	■										
Light Siam (227)							■				■	■	■			■	■	
Light Topaz (226)			■	■							■	■						
Light Turquoise (263)			■	■												■	■	
Padparadscha (542)			■	■														
Peridot (214)			■	■			■	■			■	■				■	■	
Rose (209)			■	■				■			■	■	■			■	■	
Rose Peach (262)			■	■			■											
Ruby (501)							■	■										
Sapphire (206)			■	■			■	■			■	■				■	■	
Scarlet (276)			■	■	■		■	■	■		■	■	■			■	■	■
Siam (208)			■	■							■	■	■			■	■	
Smoked Amber (1001)*			■	■			■	■			■	■						
Tanzanite (539)			■	■	■		■	■										
Violet (371)											■	■				■	■	
<b>Crystal Effects</b>																		
<b>Transparent Effects</b>																		
Crystal AB (001 AB)			■	■	■	■	■	■	■		■	■	■	■	■	■	■	■
Crystal Antique Pink (001 ANTP)							■	■								■	■	
Crystal Bermuda Blue (001 BB)											■	■	■					
Crystal Bermuda Blue P (001 BB) <sup>1</sup>													■					
Crystal Blue Shade (001 BLSH)			■	■			■	■								■	■	
Crystal Golden Shadow (001 GSHA)			■	■	■	■	■	■	■		■	■	■			■	■	
Crystal Heliotrope (001 HEL)											■	■	■					
Crystal Paradise Shine (001 PARSH)			■	■			■	■			■	■	■			■	■	
Crystal Shimmer (001 SHIM)							■	■	■		■	■	■			■	■	
Crystal Silver Night (001 SINI)			■	■			■	■	■		■	■	■	■		■	■	

\* All colors with a 4-digit color code (i.e. Golden Topaz) are fully customizable with shorter lead times and lower MOQs compared to our 3-digit colors. Please get in touch with the Customer Service for a time and quantity estimation of your desired variant.

6010 6106 6228 6428		Size	6010 Briolette Pendant	6106 Pear-shaped Pendant	6228 XILION Heart Pendant	6428 XILION Pendant
			11x5.5 mm	16 mm	10.3x10 mm	6 mm
			13x6.5 mm	22 mm	14.4x14 mm	8 mm
			17x8.5 mm	28 mm	18x17.5 mm	12 mm
			21x10.5 mm	38 mm	28 mm	
					40 mm	
Crystal Silver Shade (001 SSHA)			■	■		■
Crystal Vitrail Light (001 VL)					■	■
Crystal Vitrail Medium (001 VM)					■	■
<b>Color Effects</b>						
<b>Transparent Effects</b>						
Amethyst Shimmer (204 SHIM)			■	■	■	■
Aquamarine AB (202 AB)					■	■
Aquamarine Shimmer (202 SHIM)			■	■	■	■
Blue Zircon AB (229 AB)					■	
Emerald Shimmer (205 SHIM)			■	■		
Fuchsia AB (502 AB)					■	
Light Amethyst Shimmer (212 SHIM)			■	■	■	■
Light Colorado Topaz Shimmer (246 SHIM)			■	■		
Light Rose AB (223 AB)					■	■
Light Rose Shimmer (223 SHIM)			■	■	■	■
Light Sapphire Shimmer (211 SHIM)			■	■		
Light Siam AB (227 AB)					■	
Light Siam Shimmer (227 SHIM)					■	■
Light Topaz AB (226 AB)					■	
Light Topaz Shimmer (226 SHIM)					■	
Peridot AB (214 AB)					■	
Rose AB (209 AB)					■	■
Sapphire AB (206 AB)					■	
Siam AB (208 AB)					■	■
Violet AB (371 AB)					■	

6015 Polygon Drop

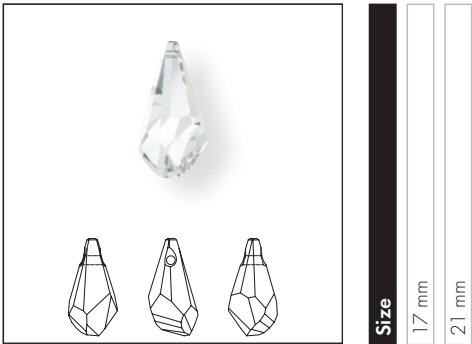

**Crystal**

Crystal (001)

**Crystal Effects**

**Transparent Effects**

Crystal Aurore Boreale (001 AB)

Crystal Golden Shadow (001 GSHA)

# Maison Margiela for Swarovski

## CRYSTALACTITE PENDANTS

Since 1988, Paris-based Maison Margiela has become famous for its collaborative team-led approach and its avant-garde transformation of classic designs. In July 2013, it presented the Maison Margiela Crystalactite for Swarovski at its Paris Haute Couture show. These were groundbreaking Crystal Fusion components inspired by natural stalactite forms and developed in creative partnership with Swarovski. Swarovski presents its interpretation of this innovative cut in pure crystalline form – the Crystalactite Pendant. Featuring a progressive

aesthetic combining partly frosted facets with primeval, irregular icicle shapes, the vision that originated in our wildest landscapes has been perfected by one of the most sophisticated design houses. With an easy-to-use hole at the top, the Pendant offers myriad design possibilities for strong, contemporary designs, and for recreating haute-couture looks.

**“Naturally and spontaneously, an imposing crystal emerges from its raw, stony origin, patiently growing into its iconic stalactite shape.”**

**6017/G** Crystalactite Pendant grand partly frosted

	30 mm	56 mm
<b>Crystal</b>		
Crystal (001)	■	■
<b>Crystal Effects</b>		
<b>Transparent Effects</b>		
Crystal Aurore Boreale V (001 ABV)	■	■
Crystal Bermuda Blue P (001 BB)	■	■
Crystal Golden Shadow V (001 GSHAV)	■	■
Crystal Vitrail Medium P (001 VM)	■	■

6020 Helix Pendant



**Size**  
18 mm  
30 mm  
37 mm

- Crystal**
- Crystal (001)
- Crystal Effects**
- Transparent Effects**
- Crystal Aurore Boreale (001 AB)
- Crystal Golden Shadow (001 GSHA)

6022 XIRIUS Raindrop Pendant

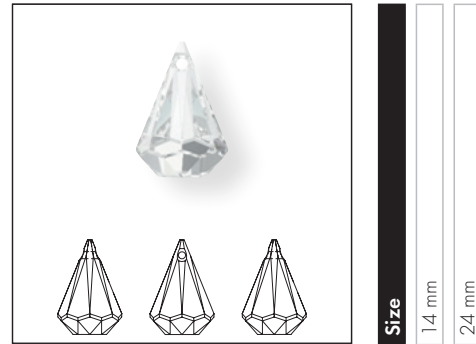

**Size**  
14 mm  
24 mm

- Crystal**
- Crystal (001)
- Crystal Effects**
- Transparent Effects**
- Crystal Aurore Boreale (001 AB)

6028 XILION Oval Pendant

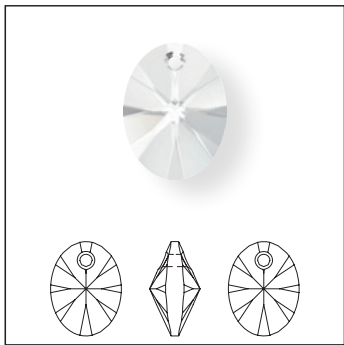

**Size**  
8 mm  
10 mm  
12 mm  
18 mm

- Crystal**
- Crystal (001)
- Crystal Effects**
- Transparent Effects**
- Crystal Aurore Boreale (001 AB)
- Crystal Silver Night (001 SINI)
- Crystal Vitrail Light P (001 VL)

6040 Helios Pendant

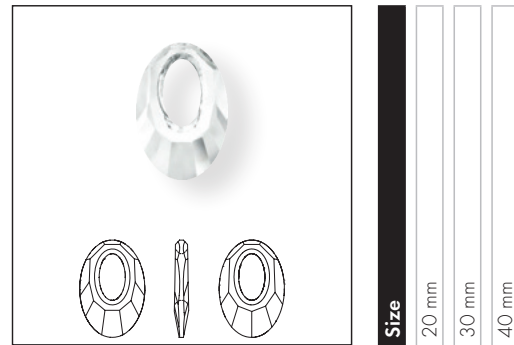

**Size**  
20 mm  
30 mm  
40 mm

- Crystal**
- Crystal (001)
- Crystal Effects**
- Transparent Effects**
- Crystal Aurore Boreale (001 AB)
- Crystal Silver Night (001 SINI)

**6049 Flat Disc Pendant**

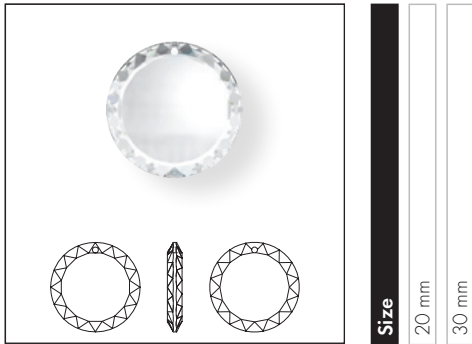

**Size**  
20 mm  
30 mm

**Crystal**

Crystal (001)

**6090 Baroque Pendant**

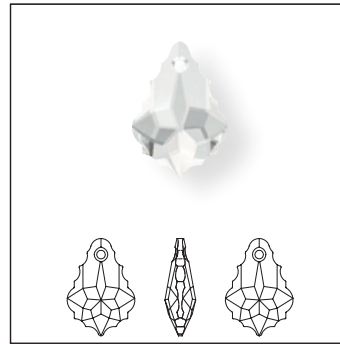

**Size**  
16x11 mm  
22x15 mm

**Crystal**

Crystal (001)

**Colors**

**Plain Colors**

Jet (280)

Ruby (501)

**Crystal Effects**

**Transparent Effects**

Crystal Aurore Boreale (001 AB)

Crystal Bermuda Blue (001 BB)

Crystal Golden Shadow (001 GSHA)

Crystal Vitrail Light (001 VL)

**6100 Elegant Pendant**

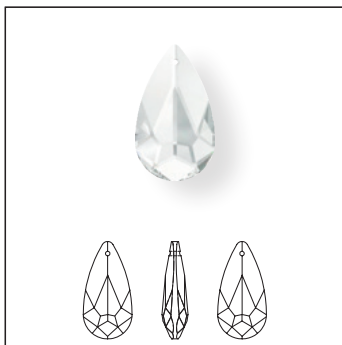

**Size**  
24x12 mm

**Crystal**

Crystal (001)

**Crystal Effects**

**Transparent Effects**

Crystal Aurore Boreale (001 AB)

Crystal Bermuda Blue (001 BB)

Crystal Vitrail Light (001 VL)

Crystal Vitrail Medium (001 VM)

**6128 XILLION Mini Pear Pendant**

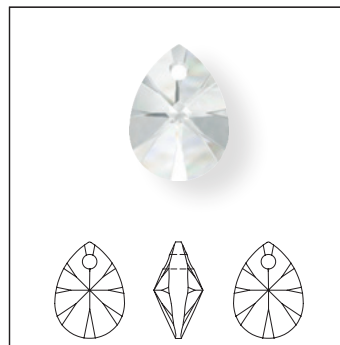

**Size**  
8 mm  
10 mm  
12 mm

**Crystal**

Crystal (001)

**Crystal Effects**

**Transparent Effects**

Crystal Aurore Boreale (001 AB)

Crystal Golden Shadow (001 GSHA)

Crystal Paradise Shine (001 PARSH)

6210 Lunar Pendant

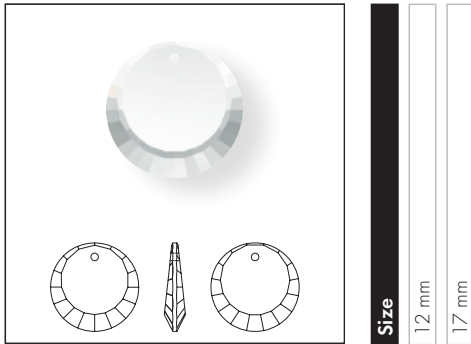

**Size**  
12 mm  
17 mm

**Crystal**

Crystal (001)

**Crystal Effects**

**Transparent Effects**

Crystal Aurore Boreale (001 AB)

6215 Classic Heart Pendant

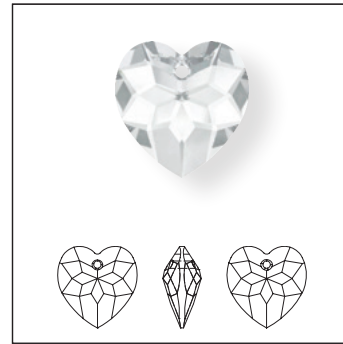

**Size**  
18 mm

**Crystal**

Crystal (001)

**Crystal Effects**

**Transparent Effects**

Crystal Aurore Boreale (001 AB)

Crystal Bermuda Blue P (001 BB)

Crystal Vitrail Light (001 VL)

6225 Flat Heart Pendant

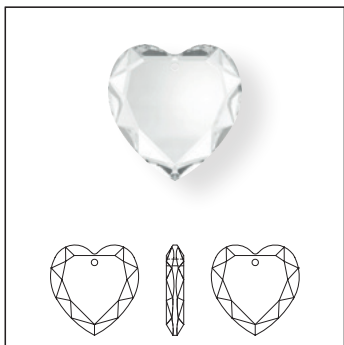

**Size**  
10 mm  
18 mm  
28 mm

**Crystal**

Crystal (001)

6240 Wild Heart Pendant



**Size**  
12 mm  
17 mm  
27 mm

**Crystal**

Crystal (001)

**Crystal Effects**

**Transparent Effects**

Crystal Aurore Boreale (001 AB)

# ”Love Story of the Heart“ by Manish Arora

Since the beginning of his international career, the award-winning, Delhi-based designer Manish Arora has worked creatively with Swarovski. In 2009, he created a memorable collection of crystalline Transfers. One year later, India's best-loved and most prolific design talent renewed his partnership with Swarovski and created a special collection of heart-shaped Pendants, which were launched in February 2011. Each individual piece is an expression of love's different emotional states and is named accordingly.

The partnership with Manish Arora is symbolic of how Swarovski engages in mutually rewarding creative partnerships with the world's best and brightest design spirits.

“The heart shape is very close to me because it is the universal symbol of love. I wanted to bring this symbol to life by creating a collection of crystal pendants and I hope people will wear them as a personal expression of the beauty and purity of this emotion.” Manish Arora

**6261** Devoted 2 U Heart

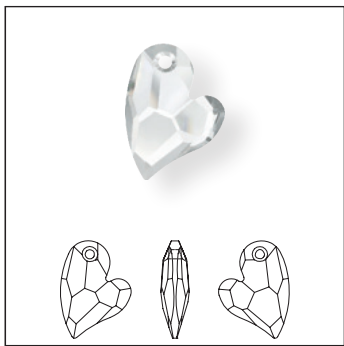

<b>Size</b>	17 mm	27 mm
<b>Crystal</b>	Crystal (001)	
<b>Crystal Effects</b>	Transparent Effects	
<b>Transparent Effects</b>	Crystal Aurore Boreale (001 AB)	

**6264** Truly in Love Heart

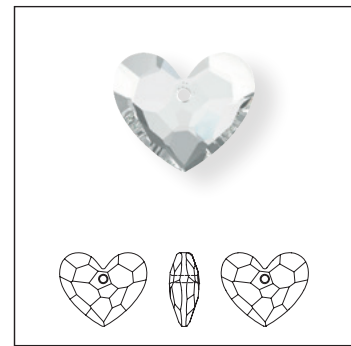

<b>Size</b>	18 mm	28 mm
<b>Crystal</b>	Crystal (001)	
<b>Crystal Effects</b>	Transparent Effects	
<b>Transparent Effects</b>	Crystal Aurore Boreale (001 AB)	
<b>Transparent Effects</b>	Crystal Bermuda Blue P (001 BB)	



**6328** XILION Bi-Cone Pendant

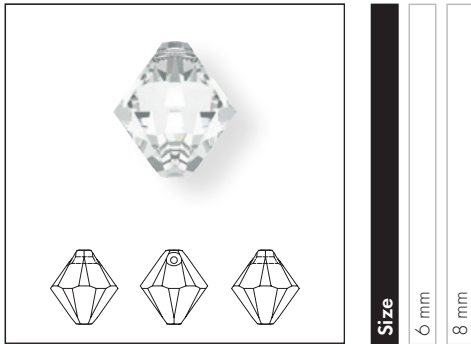

Size  
6 mm  
8 mm

- Crystal**
- Crystal (001)
- Colors**
- Plain Colors**
- Aquamarine (202)
- Light Rose (223)
- Violet (371)
- Crystal Effects**
- Transparent Effects**
- Crystal Aurore Boreale (001 AB)
- Crystal Golden Shadow (001 GSHA)

**6401** Octagon Pendant

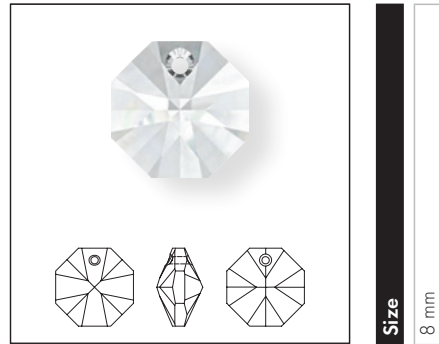

Size  
8 mm

- Crystal**
- Crystal (001)
- Crystal Effects**
- Transparent Effects**
- Crystal Aurore Boreale (001 AB)
- Crystal Golden Shadow (001 GSHA)
- Crystal Silver Shade (001 SSHA)

**6430** Classic Cut Pendant



Crystal	8 mm	10 mm	14 mm
Crystal (001)	■	■	■
<b>Colors</b>			
<b>Plain Colors</b>			
Amethyst (204)	■	■	■
Aquamarine (202)	■	■	■
Blue Zircon (229)	■	■	■
Emerald (205)	■	■	■
Light Amethyst (212)	■	■	■
Montana (207)	■	■	■
Peridot (214)	■	■	■
Rose (209)	■	■	■
Sapphire (206)	■	■	■
Scarlet (276)	■	■	■
Siam (208)	■	■	■
<b>Crystal Effects</b>			
<b>Transparent Effects</b>			
Crystal Aurore Boreale (001 AB)	■	■	■
Crystal Bermuda Blue P (001 BB)	■	■	■
Crystal Golden Shadow (001 GSHA)	■	■	■
Crystal Shimmer (001 SHIM)	■	■	■
Crystal Silver Night (001 SINI)	■	■	■
Crystal Vitrail Light P (001 VL)	■	■	■
Crystal Vitrail Medium P (001 VM)	■	■	■
<b>Color Effects</b>			
<b>Transparent Effects</b>			
Aquamarine Shimmer (202 SHIM)	■	■	■
Light Rose Shimmer (223 SHIM)	■	■	■

**6431** Princess Cut Pendant

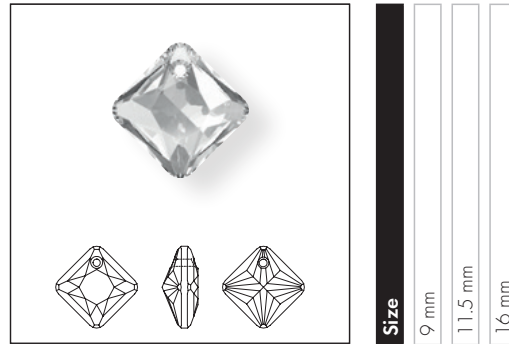

Crystal	9 mm	11.5 mm	16 mm
Crystal (001)	■	■	■
<b>Crystal Effects</b>			
<b>Transparent Effects</b>			
Crystal Aurore Boreale (001 AB)	■	■	■
Crystal Bermuda Blue P (001 BB)	■	■	■
Crystal Golden Shadow (001 GSHA)	■	■	■
Crystal Shimmer (001 SHIM)	■	■	■
Crystal Silver Night (001 SINI)	■	■	■
Crystal Vitrail Light P (001 VL)	■	■	■
Crystal Vitrail Medium P (001 VM)	■	■	■

6432 Heart Cut Pendant

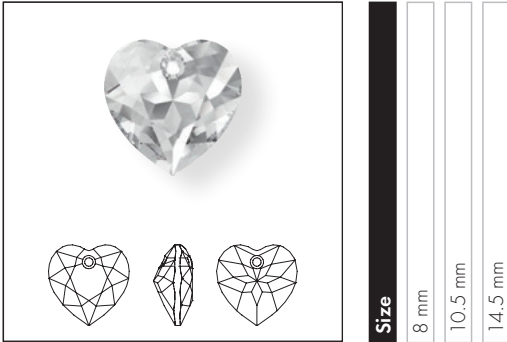

Crystal	8 mm	10.5 mm	14.5 mm
Crystal (001)	■	■	■
<b>Colors</b>			
<b>Plain Colors</b>			
Amethyst (204)	■	■	■
Aquamarine (202)	■	■	■
Light Rose (223)	■	■	■
Light Siam (227)	■	■	■
Montana (207)	■	■	■
Rose (209)	■	■	■
Scarlet (276)	■	■	■
Siam (208)	■	■	
<b>Crystal Effects</b>			
<b>Transparent Effects</b>			
Crystal Aurore Boreale (001 AB)	■	■	■
Crystal Bermuda Blue P (001 BB)	■	■	■
Crystal Golden Shadow (001 GSHA)	■	■	■
Crystal Shimmer (001 SHIM)	■	■	■
Crystal Silver Night (001 SINI)	■	■	■
Crystal Vitrail Light P (001 VL)	■	■	■
Crystal Vitrail Medium P (001 VM)	■	■	■
<b>Color Effects</b>			
<b>Transparent Effects</b>			
Aquamarine Shimmer (202 SHIM)	■	■	■
Light Rose Shimmer (223 SHIM)	■	■	■

6433 Pear Cut Pendant

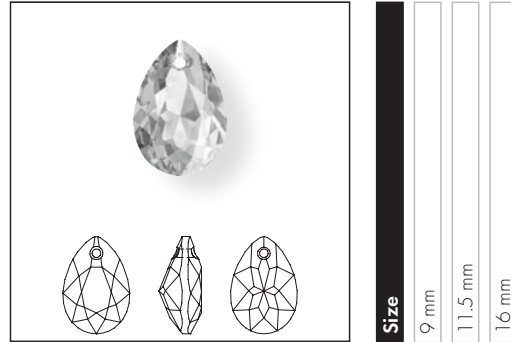

Crystal	9 mm	11.5 mm	16 mm
Crystal (001)	■	■	■
<b>Crystal Effects</b>			
<b>Transparent Effects</b>			
Crystal Aurore Boreale (001 AB)	■	■	■
Crystal Bermuda Blue P (001 BB)	■	■	■
Crystal Golden Shadow (001 GSHA)	■	■	■
Crystal Shimmer (001 SHIM)	■	■	■
Crystal Silver Night (001 SINI)	■	■	■
Crystal Vitrail Light P (001 VL)	■	■	■
Crystal Vitrail Medium P (001 VM)	■	■	■
<b>Color Effects</b>			
<b>Transparent Effects</b>			
Amethyst Shimmer (204 SHIM)		■	■
Aquamarine Shimmer (202 SHIM)	■	■	■
Emerald Shimmer (205 SHIM)		■	■
Light Rose Shimmer (223 SHIM)		■	■

**6434** Trilliant Cut Pendant



Crystal	8 mm	10.5 mm	14.5 mm
Crystal (001)	■	■	■
<b>Colors</b>			
<b>Plain Colors</b>			
Amethyst (204)	■	■	■
Aquamarine (202)	■	■	■
Blue Zircon (229)	■	■	■
Citrus Green (337)	■	■	■
Emerald (205)	■	■	■
Golden Topaz (1003)	■	■	■
Light Amber (1002)	■	■	■
Light Amethyst (212)	■	■	■
Light Rose (223)	■	■	■
Light Siam (227)	■	■	■
Peridot (214)	■	■	■
Rose (209)	■	■	■
Sapphire (206)	■	■	■
Scarlet (276)	■	■	■
Siam (208)	■	■	■
<b>Crystal Effects</b>			
<b>Transparent Effects</b>			
Crystal Aurore Boreale (001 AB)	■	■	■
Crystal Bermuda Blue P (001 BB)	■	■	■
Crystal Golden Shadow (001 GSHA)	■	■	■
Crystal Shimmer (001 SHIM)	■	■	■
Crystal Silver Night (001 SINI)	■	■	■
Crystal Vitrail Light P (001 VL)	■	■	■
Crystal Vitrail Medium P (001 VM)	■	■	■

**6435** Emerald Cut Pendant

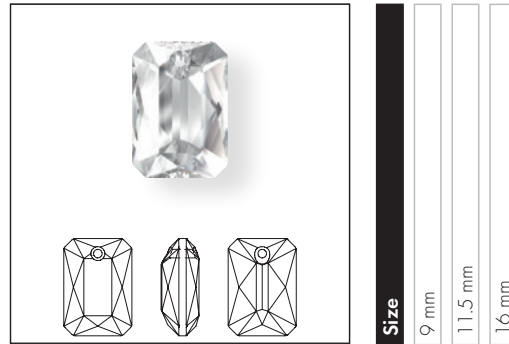

Crystal	9 mm	11.5 mm	16 mm
Crystal (001)	■	■	■
<b>Crystal Effects</b>			
<b>Transparent Effects</b>			
Crystal Aurore Boreale (001 AB)	■	■	■
Crystal Bermuda Blue P (001 BB)	■	■	■
Crystal Golden Shadow (001 GSHA)	■	■	■
Crystal Shimmer (001 SHIM)	■	■	■
Crystal Silver Night (001 SINI)	■	■	■
Crystal Vitrail Light P (001 VL)	■	■	■
Crystal Vitrail Medium P (001 VM)	■	■	■

6436 Majestic Pendant



Size	9 mm	11.5 mm	16 mm
------	------	---------	-------

**Crystal**

Crystal (001)

**Colors**

**Plain Colors**

Amethyst (204)

Aquamarine (202)

Blue Zircon (229)

Citrus Green (337)

Emerald (205)

Golden Topaz (1003)

Jonquil (213)

Light Amber (1002)

Light Amethyst (212)

Light Rose (223)

Peridot (214)

Rose (209)

Sapphire (206)

Scarlet (276)

Siam (208)

**Crystal Effects**

**Transparent Effects**

Crystal Aurore Boreale (001 AB)

Crystal Bermuda Blue P (001 BB)

Crystal Golden Shadow (001 GSHA)

Crystal Shimmer (001 SHIM)

Crystal Silver Night (001 SINI)

Crystal Vitrail Light P (001 VL)

Crystal Vitrail Medium P (001 VM)

Crystal (001)	■	■	■
Amethyst (204)	■	■	■
Aquamarine (202)	■	■	■
Blue Zircon (229)	■	■	■
Citrus Green (337)	■	■	■
Emerald (205)	■	■	■
Golden Topaz (1003)	■	■	■
Jonquil (213)	■	■	■
Light Amber (1002)	■	■	■
Light Amethyst (212)	■	■	■
Light Rose (223)	■	■	■
Peridot (214)	■	■	■
Rose (209)	■	■	■
Sapphire (206)	■	■	■
Scarlet (276)	■	■	■
Siam (208)	■	■	■
Crystal Aurore Boreale (001 AB)		■	■
Crystal Bermuda Blue P (001 BB)	■	■	■
Crystal Golden Shadow (001 GSHA)		■	■
Crystal Shimmer (001 SHIM)		■	■
Crystal Silver Night (001 SINI)		■	■
Crystal Vitrail Light P (001 VL)	■	■	■
Crystal Vitrail Medium P (001 VM)	■	■	■

**6438** Elliptic Cut Pendant



**Size** 9 mm

**6438** Elliptic Cut Pendant



**Size** 11.5, 16 mm

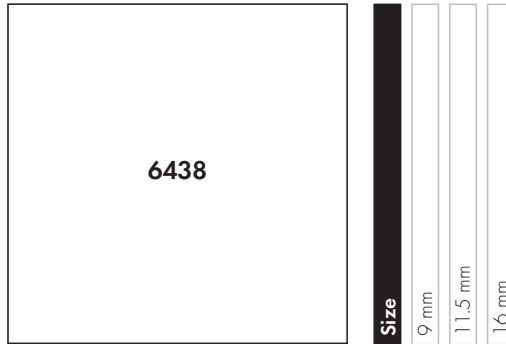

**Size**

9 mm

11.5 mm

16 mm

**Crystal**

Crystal (001)

**Colors**

**Plain Colors**

Amethyst (204)

Aquamarine (202)

Blue Zircon (229)

Emerald (205)

Light Amethyst (212)

Light Rose (223)

Peridot (214)

Rose (209)

Sapphire (206)

Scarlet (276)

Topaz (203)

**Crystal Effects**

**Transparent Effects**

Crystal Aurore Boreale (001 AB)

Crystal Bermuda Blue P (001 BB)

Crystal Golden Shadow (001 GSHA)

Crystal Shimmer (001 SHIM)

Crystal Silver Night (001 SINI)

Crystal Vitrail Light P (001 VL)

Crystal Vitrail Medium P (001 VM)

6460 Column Pendant

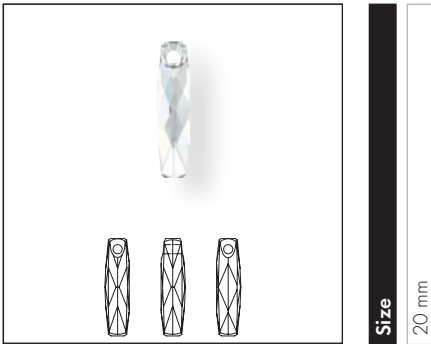

Size  
20 mm

Crystal

Crystal (001)

Crystal Effects

Transparent Effects

Crystal Aurore Boreale (001 AB)

Crystal Silver Shade (001 SSHA)

6480 Spike Pendant

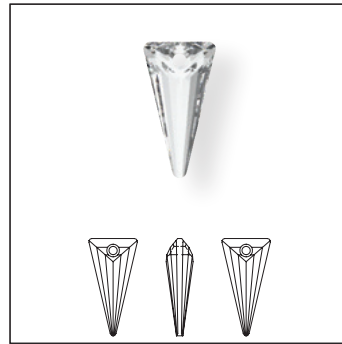

Size  
18 mm  
28 mm  
39 mm

Crystal

Crystal (001)

Colors

Plain Colors

Jet (280)

Crystal Effects

Transparent Effects

Crystal Aurore Boreale (001 AB)

Crystal Bermuda Blue P (001 BB)

Crystal Blue Shade (001 BLSH)

Crystal Golden Shadow (001 GSHA)

Crystal Silver Night (001 SINI)

Crystal Vitrail Medium P (001 VM)

6533 Raindrop Pendant

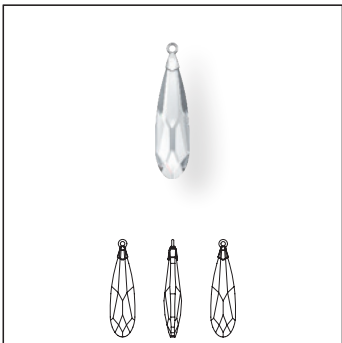

Size  
17.5 mm Gold colored plating  
17.5 mm Rhodium plating  
23 mm Gold colored plating  
23 mm Rhodium plating  
33 mm Gold colored plating  
33 mm Rhodium plating

Crystal

Crystal (001)

Crystal Effects

Transparent Effects

Crystal Bermuda Blue (001 BB)

Crystal Golden Shadow (001 GSHA)

6565 Metallic Cap Pear-shaped Pendant



Size  
18 mm  
22 mm

Crystal Effects

Metallic Effects

Crystal & Light Chrome Z MCI (001 LTCHZ)

Color Effects

Metallic Effects

Aquamarine & Light Chrome Z MCI (202 LTCHZ)

**6628** XILION Triangle Pendant

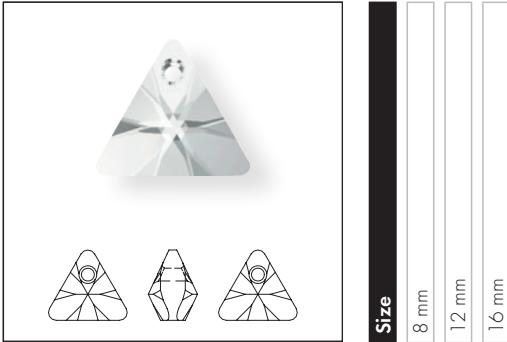

Crystal	8 mm	12 mm	16 mm
Crystal (001)	■	■	■
<b>Crystal Effects</b>			
<b>Transparent Effects</b>			
Crystal Aurore Boreale (001 AB)	■	■	■
Crystal Bermuda Blue P (001 BB)	■	■	■
Crystal Silver Night (001 SINI)	■	■	■
Crystal Vitrail Light P (001 VL)	■	■	■

**6656** Galactic Vertical Pendant

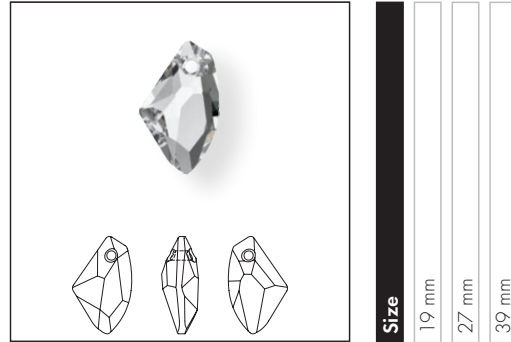

Crystal	19 mm	27 mm	39 mm
Crystal (001)	■	■	■
<b>Colors</b>			
<b>Plain Colors</b>			
Aquamarine (202)	■	■	■
Light Rose (223)	■	■	■
Peridot (214)	■	■	■
Tanzanite (539)	■	■	■
<b>Crystal Effects</b>			
<b>Transparent Effects</b>			
Crystal Bermuda Blue P (001 BB)	■	■	■
Crystal Golden Shadow (001 GSHA)	■	■	■
Crystal Moonlight (001 MOL)	■	■	■
Crystal Silver Shade (001 SSHA)	■	■	■

**6670** De-Art Pendant

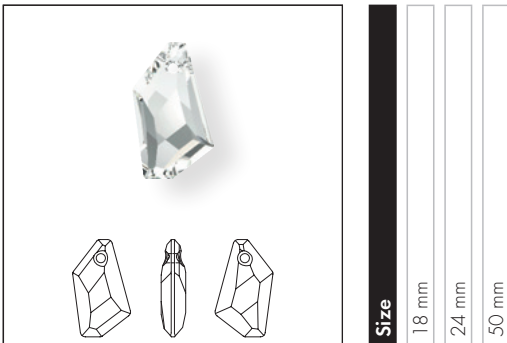

Crystal	18 mm	24 mm	50 mm
Crystal (001)	■	■	■
<b>Colors</b>			
<b>Plain Colors</b>			
Aquamarine (202)	■	■	■
<b>Crystal Effects</b>			
<b>Transparent Effects</b>			
Crystal Aurore Boreale (001 AB)	■	■	■
Crystal Bermuda Blue P (001 BB)	■	■	■
Crystal Golden Shadow (001 GSHA)	■	■	■
Crystal Silver Night (001 SINI)	■	■	■



6673 Meteor Pendant

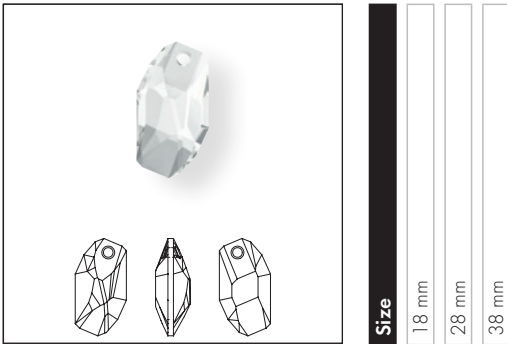

Size  
18 mm  
28 mm  
38 mm

- Crystal**
- Crystal (001)
- Colors**
- Plain Colors**
- Light Turquoise (263)
- Crystal Effects**
- Transparent Effects**
- Crystal Aurore Boreale (001 AB)
- Crystal Golden Shadow (001 GSHA)

6680 Cosmic Pendant

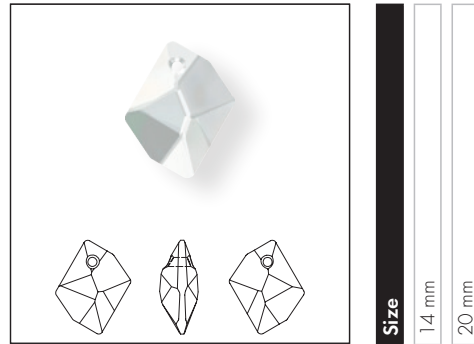

Size  
14 mm  
20 mm

- Crystal**
- Crystal (001)
- Crystal Effects**
- Transparent Effects**
- Crystal Aurore Boreale (001 AB)
- Crystal Golden Shadow (001 GSHA)

6685 Graphic Pendant

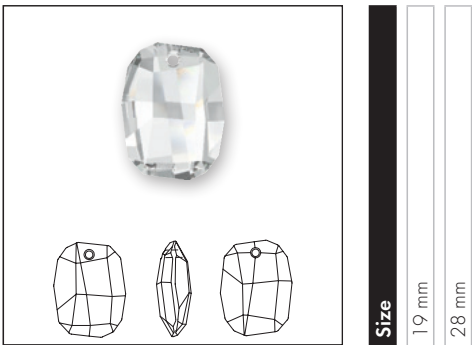

Size  
19 mm  
28 mm

- Crystal**
- Crystal (001)
- Colors**
- Plain Colors**
- Emerald (205)
- Crystal Effects**
- Transparent Effects**
- Crystal Aurore Boreale (001 AB)
- Crystal Golden Shadow (001 GSHA)

6690 Wing Pendant

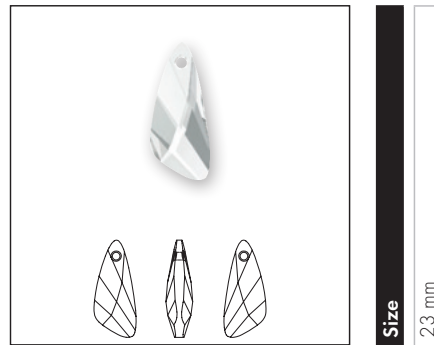

Size  
23 mm

- Crystal**
- Crystal (001)
- Colors**
- Plain Colors**
- Capri Blue (243)
- Crystal Effects**
- Transparent Effects**
- Crystal Aurore Boreale (001 AB)
- Crystal Silver Night (001 SINI)

**6696 Urban Pendant**

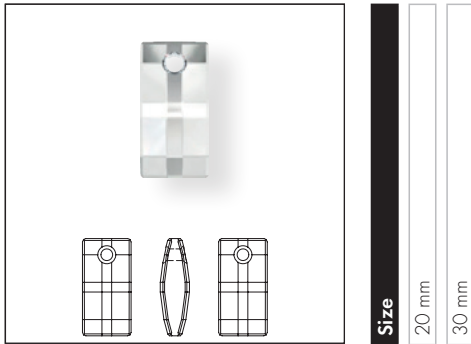

**Size**  
20 mm  
30 mm

**Crystal**

Crystal (001)

**Crystal Effects**

**Transparent Effects**

Crystal Aurore Boreale (001 AB)

Crystal Bermuda Blue P (001 BB)

Crystal Silver Night (001 SINI)

**6704 Snowflake Pendant**

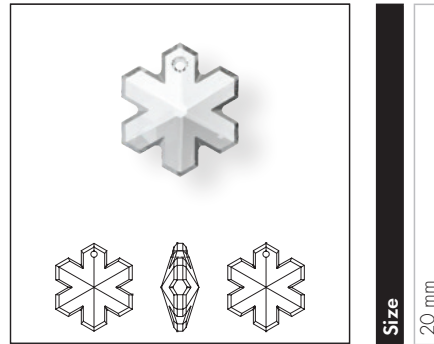

**Size**  
20 mm

**Crystal**

Crystal (001)

**Crystal Effects**

**Transparent Effects**

Crystal Aurore Boreale (001 AB)

**6714 Star Pendant**

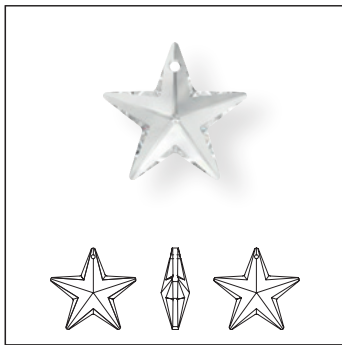

**Size**  
20 mm  
28 mm  
40 mm

**Crystal**

Crystal (001)

**Crystal Effects**

**Transparent Effects**

Crystal Aurore Boreale (001 AB)

**6721 Starfish Pendant**

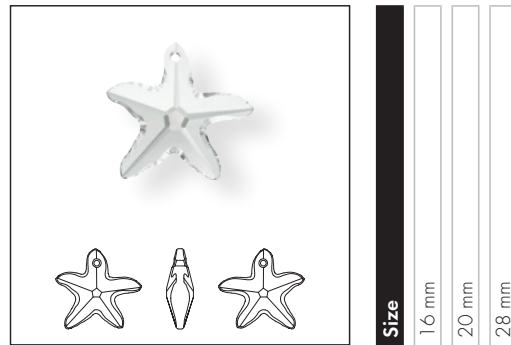

**Size**  
16 mm  
20 mm  
28 mm

**Crystal**

Crystal (001)

**Crystal Effects**

**Transparent Effects**

Crystal Aurore Boreale (001 AB)

Crystal Bermuda Blue P (001 BB)

# Ocean Mysteries designed by Céline Cousteau

**Design Story:** A love for the sea runs through her veins: Céline Cousteau is a celebrated filmmaker, humanitarian, and environmentalist, as well as the granddaughter of legendary ocean explorer Jacques-Yves Cousteau. She presents her first ever designs made of crystals for Swarovski, inspired by one of her favorite places, the depths of the ocean. Taking inspiration from nature itself

and leaving its beauty unaltered, her stunningly life-like creatures are not only captivating and spellbinding, they also draw attention toward the mysterious, mostly unseen, and unexplored world beneath the ocean's surface on which all ocean life depends. These mysteries need to be protected for future generations, both above and below the water.

**6731** Sea Snail Pendant partly frosted

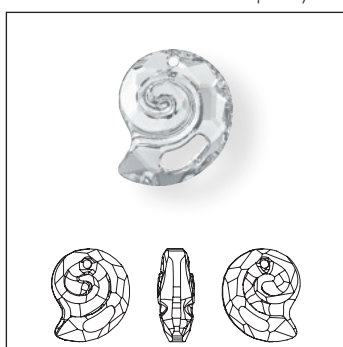

**Size** 14 mm

**6731** Sea Snail Pendant partly frosted



**Size** 28 mm

6731

<b>Crystal</b>	Crystal (001)		
<b>Crystal Effects</b>			
<b>Transparent Effects</b>			
	Crystal Aurore Boreale (001 AB)		

Size

14 mm

28 mm

**6735** Leaf Pendant

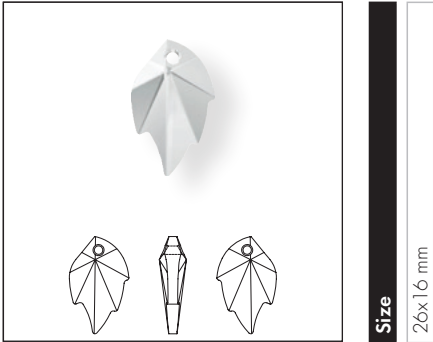

**Size**  
26x16 mm

- Crystal**
- Crystal (001)
- Colors**
- Plain Colors**
- Emerald (205)
- Crystal Effects**
- Transparent Effects**
- Crystal Aurore Boreale (001 AB)
- Crystal Golden Shadow (001 GSHA)

**6744** Flower Pendant

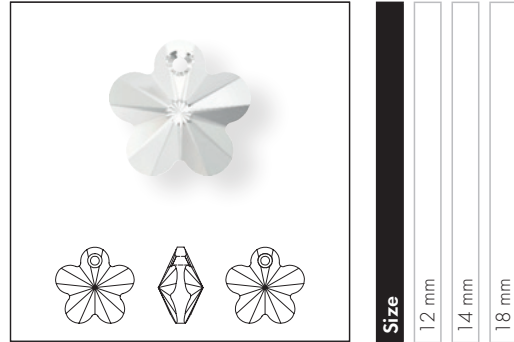

**Size**  
12 mm  
14 mm  
18 mm

- Crystal**
- Crystal (001)
- Crystal Effects**
- Transparent Effects**
- Crystal Aurore Boreale (001 AB)

**6748** Edelweiss Pendant

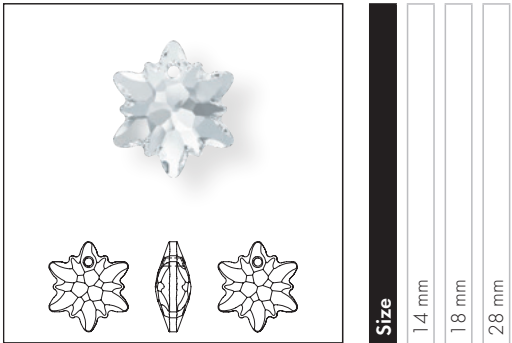

**Size**  
14 mm  
18 mm  
28 mm

- Crystal**
- Crystal (001)
- Crystal Effects**
- Transparent Effects**
- Crystal Aurore Boreale (001 AB)

**6864** Cross Pendant

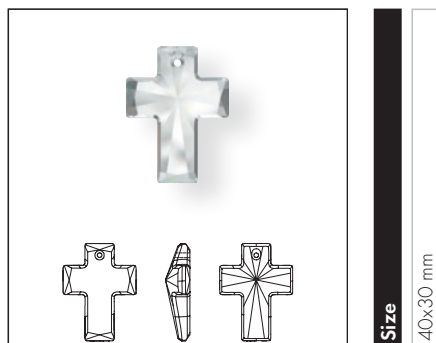

Size

40x30 mm

**Crystal**

Crystal (001)

**Crystal Effects**

**Transparent Effects**

Crystal Aurore Boreale V (001 ABV)

**6866** Square Cross Pendant

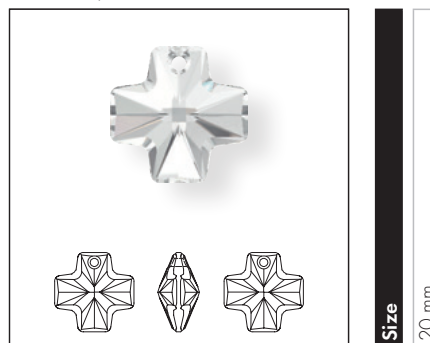

Size

20 mm

**Crystal**

Crystal (001)

**Crystal Effects**

**Transparent Effects**

Crystal Aurore Boreale (001 AB)

# Product Details

Article Size	Packing Unit = Minimum Order Quantity in Pieces	Average Net Weight in Gram per Packing Unit Crystal (001)	Average Gross Weight in Gram per Packing Unit Crystal (001)
<b>6000</b>			
11x5.5 mm	288	99.8	123.1
13x6.5 mm	288	156.9	197.5
15x7.5 mm	144	129.8	153.4
22x11 mm	48	129.4	151.3
<b>6002</b>			
10x7 mm	144	91.4	109.3
15x11.5 mm	72	175.4	197.3
<b>6007</b>			
7x4 mm	360	46.7	55.8
9x5 mm	288	77.1	104.2
<b>6010</b>			
11x5.5 mm	144	57.4	75.9
13x6.5 mm	144	91.1	109.0
17x8.5 mm	36	57.3	77.2
21x10.5 mm	24	66.3	83.4
<b>6015</b>			
17 mm	72	93.2	111.5
21 mm	48	105.9	129.3
<b>6017/G</b>			
30 mm	12	25.0	45.6
56 mm	6	67.5	91.4
<b>6020</b>			
18 mm	36	49.7	72.1
30 mm	12	74.3	95.5
37 mm	6	76.4	82.5
<b>6022</b>			
14 mm	72	77.2	97.0
24 mm	24	133.9	155.5
<b>6028</b>			
8 mm	144	31.8	40.9
10 mm	192	71.0	97.7
12 mm	108	68.9	92.9
18 mm	72	146.5	170.3
<b>6040</b>			
20 mm	72	66.3	92.8
30 mm	30	85.4	116.4
40 mm	6	41.7	61.4
<b>6049</b>			
20 mm	72	170.5	200.4
30 mm	24	166.7	209.2
<b>6090</b>			
16x11 mm	72	55.8	75.8
22x15 mm	48	102.2	136.7
<b>6100</b>			
24x12 mm	36	54.5	83.9

Article Size	Packing Unit = Minimum Order Quantity in Pieces	Average Net Weight in Gram per Packing Unit Crystal (001)	Average Gross Weight in Gram per Packing Unit Crystal (001)
<b>6106</b>			
16 mm	144	129.9	158.3
22 mm	96	208.1	248.5
28 mm	36	171.8	201.1
38 mm	9	91.1	121.6
<b>6128</b>			
8 mm	144	23.2	34.0
10 mm	144	52.3	80.0
12 mm	144	81.8	101.3
<b>6210</b>			
12 mm	144	67.8	90.9
17 mm	72	98.8	122.0
<b>6215</b>			
18 mm	72	183.2	210.5
<b>6225</b>			
10 mm	144	48.3	68.4
18 mm	24	41.6	59.0
28 mm	24	160.7	206.2
<b>6228</b>			
10.3x10 mm	288	124.6	152.6
14.4x14 mm	144	181.4	210.5
18x17.5 mm	72	188.0	211.7
28 mm	16	124.0	158.7
40 mm	6	155.2	182.9
<b>6240</b>			
12 mm	108	63.3	83.5
17 mm	72	116.4	137.0
27 mm	24	142.6	147.8
<b>6261</b>			
17 mm	48	48.2	76.6
27 mm	20	77.0	102.6
<b>6264</b>			
18 mm	48	93.4	109.1
28 mm	16	93.7	118.2
<b>6328</b>			
6 mm	360	78.5	89.5
8 mm	288	153.2	173.2
<b>6401</b>			
8 mm	288	106.8	123.8
<b>6428</b>			
6 mm	720	80.1	89.5
8 mm	144	37.4	46.7
12 mm	144	121.8	141.6
<b>6430</b>			
8 mm	72	23.7	42.1
10 mm	48	31.7	51.9
14 mm	24	40.9	61.6

Article Size	Packing Unit = Minimum Order Quantity in Pieces	Average Net Weight in Gram per Packing Unit Crystal (001)	Average Gross Weight in Gram per Packing Unit Crystal (001)
<b>6431</b>			
9 mm	72	22.1	40.5
11.5 mm	48	30.1	51.1
16 mm	24	41,9	62.6
<b>6432</b>			
8 mm	72	21.9	40.3
10.5 mm	48	31.6	51.8
14.5 mm	24	40.0	60.7
<b>6433</b>			
9 mm	72	18.1	33.2
11.5 mm	48	28.8	46.1
16 mm	36	54.0	71.9
<b>6434</b>			
8 mm	72	20.1	40.3
10.5 mm	48	30.5	51.1
14.5 mm	24	38.5	59.2
<b>6435</b>			
9 mm	72	24.2	42.8
11.5 mm	48	35.1	53.7
16 mm	24	46.1	64.7
<b>6436</b>			
9 mm	72	26.9	45.3
11.5 mm	48	30.9	51.1
16 mm	24	47.4	65.8
<b>6438</b>			
9 mm	72	18.7	38.9
11.5 mm	48	28.3	48.5
16 mm	36	53.3	73.5
<b>6460</b>			
20 mm	72	60.3	83.1
<b>6480</b>			
18 mm	48	42.7	64.1
28 mm	36	101.6	130.5
39 mm	16	105.6	133.7
<b>6533</b>			
17.5 mm	36	11.6	31.8
23 mm	24	14.6	35.4
33 mm	12	22.7	43.4
<b>6565</b>			
18 mm	36	43.6	64.2
22 mm	24	54.9	75.0
<b>6628</b>			
8 mm	288	72.6	72.8
12 mm	144	101.6	126.9
16 mm	72	128.2	155.1
<b>6656</b>			
19 mm	48	72.3	94.2
27 mm	30	126.1	159.6
39 mm	6	61.8	82.0



Article Size	Packing Unit = Minimum Order Quantity in Pieces	Average Net Weight in Gram per Packing Unit Crystal (001)	Average Gross Weight in Gram per Packing Unit Crystal (001)
<b>6670</b>			
18 mm	72	68.4	104.6
24 mm	48	105.5	161.9
50 mm	6	104.7	126.8
<b>6673</b>			
18 mm	48	59.7	80.7
28 mm	20	89.0	112.2
38 mm	6	69.5	87.1
<b>6680</b>			
14 mm	144	118.7	145.1
20 mm	72	167.5	191.1
<b>6685</b>			
19 mm	48	104.5	127.4
28 mm	24	168.7	175.4
<b>6690</b>			
23 mm	36	54.5	88.6
<b>6696</b>			
20 mm	24	53.5	70.6
30 mm	10	59.6	83.3
<b>6704</b>			
20 mm	48	131.4	155.0
<b>6714</b>			
20 mm	48	48.2	73.1
28 mm	24	112.5	156.1
40 mm	6	56.1	87.4
<b>6721</b>			
16 mm	72	105.1	131.7
20 mm	30	76.8	113.6
28 mm	12	66.3	93.7
<b>6731</b>			
14 mm	36	35.1	64.0
28 mm	8	76.4	98.2
<b>6735</b>			
26x16 mm	30	73.3	110.0
<b>6744</b>			
12 mm	144	118.7	145.4
14 mm	144	172.9	204.5
18 mm	72	174.8	207.2
<b>6748</b>			
14 mm	72	65.3	90.0
18 mm	48	88.3	110.2
28 mm	18	115.7	145.4
<b>6864</b>			
40x30 mm	9	109.2	142.2
<b>6866</b>			
20 mm	72	249.5	272.8



# Crystal Transfers

Swarovski Crystal Transfers are captivating motifs made from Swarovski Flat Backs Hotfix, utilizing XIRIUS and XILION Roses, Creation Stones, as well as Cabochons or Metallics in varying designs.











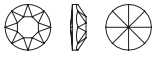





















Able to incorporate up to 18 different elements or colors in the one motif, with a seamless and effortless application process for myriad textiles, sparkling creativity has never appeared so easy. Swarovski Crystal Transfers prove to be an excellent choice for Hotfix application on a wide range of apparel and accessories. Moreover, the self-adhesive Crystal IT Transfers can be affixed to hard, non-washable surfaces.

Our range of Inspirational Motifs is designed to offer a glimpse into the vast array of Transfer possibilities, and may be ordered as they are or modified to the customer's desire, with our Design Experts able to assist in realizing any unique customization requirement. The assortment is a balanced mix of large and small motifs in all price categories, as well as a good representation of all the different elements that can be used in Crystal Transfer motifs.



# Overview of Flat Backs Hotfix for Crystal Transfers

Detailed information per Flat Back Hotfix may be found in chapter "Flat Backs Hotfix" pages 84 to 113.

1 2 3		<b>1098 A HF</b> PP 24 (SS 12), PP 31 (SS 16) SS 20	1 2		<b>2303 M HF</b> 8x5, 14x9 mm	1 2		<b>2738 M HF</b> 10x5, 12x6 mm
		<b>2000 A HF</b> SS 3			<b>2304 M HF</b> 10x2.8, 14x3.9 mm			<b>2739 M HF</b> 5.8x5.3, 7x6.5 mm
		<b>2038 A HF</b> SS 5, 6, 8, 10			<b>2400 M HF</b> 2.2, 3, 4, 6 mm			<b>2740 M HF</b> 8.3x8.3, 10x10 mm
		<b>2038/1 A HF</b> SS 10			<b>2471 M HF</b> 5, 7, 10 mm			<b>2754 M HF</b> 4, 6 mm
		<b>2078 A HF</b> SS 12, 16, 20, 30, 34, 40, 48			<b>2472 M HF</b> 5, 7, 10 mm			<b>2770 M HF</b> 6x3.5 mm
		<b>2078/1 A HF</b> SS 16, 20			<b>2510 M HF</b> 3.7x1.9, 5x2.5 mm			<b>2771 M HF</b> 6.4x4.2, 8.6x5.6, 12.9x8.3 mm
		<b>2080/4 HF</b> SS 6, 10, 16, 20, 34			<b>2555 M HF</b> 8x2.6, 12x4 mm			<b>2772 M HF</b> 6.5x2.1, 8.6x2.8, 12.9x4.2 mm
		<b>2200 HF</b> 4x2, 8x4 mm			<b>2602 M HF</b> 3.7x2.5, 8x5.5, 14x10 mm			<b>2773 M HF</b> 5x3, 6.6x3.9, 9.9x5.9 mm
		<b>2201 M HF</b> 4x1.8, 8x3.5, 14x6 mm			<b>2603 M HF</b> 4x3, 8x6, 14x10 mm			<b>2774 M HF</b> 6.3x4.2, 8.3x5.6, 12.5x8.4 mm
		<b>2205 M HF</b> 7.5, 10, 14 mm			<b>2711 M HF</b> 3.3, 6 mm			<b>2775 M HF</b> 5x4.2, 6.7x5.6, 10x8.4 mm
		<b>2300 M HF</b> 8x4.8 mm			<b>2715 M HF</b> 3, 4 mm			<b>2776 M HF</b> 8.2x4.2, 11x5.6, 16.5x8.4 mm

1 Top view 2 Side view 3 Back view

1 2



**2777 M HF**  
5x4.2, 6.7x5.6,  
10x8.4 mm



**2788 M HF**  
8 mm



**2808 M HF**  
3.6, 6, 10 mm



**2813 M HF**  
8x5.5 mm

# Crystal Diamonds

**1360** (with art. 1028 XILION Chaton)<sup>1</sup>

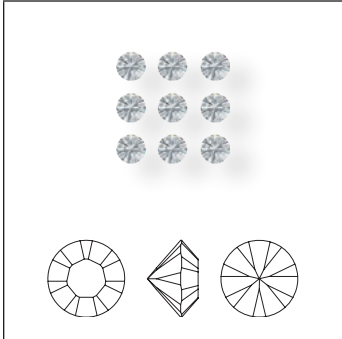

**1360** (with art. 1088 XIRIUS Chaton)<sup>1</sup>

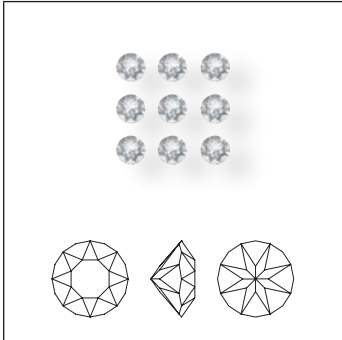

Crystal Diamonds & Metallics

<b>1360</b> <sup>1</sup>	<b>Size</b>	PP 7 (PP7 with art. 1028 XILION Chaton)	PP 12 (PP12 with art. 1028 XILION Chaton)	PP 17 (PP17 with art. 1088 XIRIUS Chaton)
<b>Crystal</b>				
Crystal (001)		<input checked="" type="checkbox"/>	<input checked="" type="checkbox"/>	<input checked="" type="checkbox"/>
<b>Colors</b>				
<b>Plain Colors</b>				
Black Diamond (215)		<input checked="" type="checkbox"/>	<input checked="" type="checkbox"/>	<input checked="" type="checkbox"/>
<b>Crystal Effects</b>				
<b>Transparent Effects</b>				
Crystal Aurore Boreale (001 AB)		<input checked="" type="checkbox"/>	<input checked="" type="checkbox"/>	<input checked="" type="checkbox"/>

<sup>1</sup>The article is only available within a Transfer, not as a loose stone

# Metallics

To add a metallic look to your Transfer, you may choose from our Metallics assortment and simply include them into your Design.



3490  
3490/006  
(M2)



3490  
3490/400  
(M4)



3490  
3490/007  
(M10)



3490  
3490/012  
(M2.5)



3490  
3490/600  
(M6)



3490  
3490/300  
(M3)



3490  
3490/008  
(M8)



Gold<sup>1</sup> brushed  
(081)



Silver brushed  
(082)



Gun metal  
brushed  
(086)



Gold<sup>1</sup> polished  
(091)



Silver polished  
(092)



Gun metal  
polished  
(096)



Bronze brushed  
(084)



Copper brushed  
(080)



Black polished  
(070)



Bronze polished  
(094)



Copper polished  
(090)



Signal White  
(R 9003<sup>2</sup>)



Jet Black  
(R 9005<sup>2</sup>)

<sup>1</sup> Golden colored

<sup>2</sup> Color tones according to RAL colors.

# Crystal Transfers and Inspirational Motifs

## ARTICLE EXPLANATION

**944269**

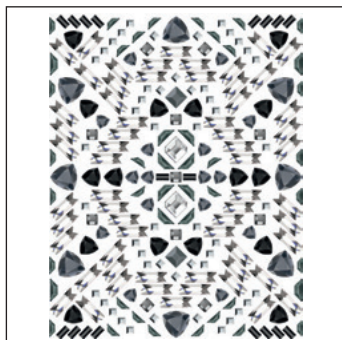

<b>C</b>	280/001LTCH/001SINI/001/ 280HEM/215/215/001/253/ 280/253
<b>E</b>	CS5x2.5/CS3x3/CS4x4/ 2555MM12x4/2400MM6/ 2772MM6.5x2.1/2772MM8.6x2.8/ 2777MM10x8.4/2472MM5/ 2472MM7/2472MM10
<b>S</b>	~95x122
<b>M</b>	4 PCS <b>35%</b>

944269	C	E	S	M	35%
Article number	Color assortment	Elements	Motif size in mm	Minimum order quantity in pieces (PCS)	% of actual size
	Color code 1 (280) corresponds to element 1 (CS5x2.5); color code 2 (001LTCH) corresponds to element 2 (CS3x3) etc.	For details of stone sizes and element codes, please refer to the product charts at the beginning of this chapter.			
	For details please refer to the product charts at the beginning of this chapter and the chapter Flat Backs Hotfix pages 84–113.				

## ORDERING EXAMPLE & PRODUCT VARIETY EXPLANATION

944269	C280	001LTCH
Article number	Color of crystals corresponding to element 1; color of the most frequently used element in the motif	Color of crystals corresponding to element 2; color of the second most frequently used element in the motif



## MOTIFS &amp; ROWS

13 458

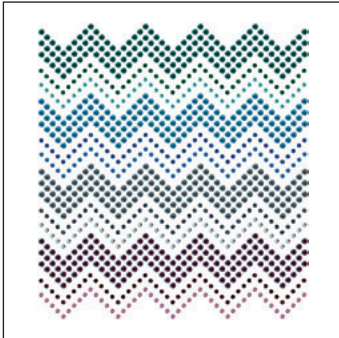

**C** 229SHIM/243/369SHIM/253/  
539SHIM/208/227SHIM/205/  
205 NIFA/243NIFA/253NIFA/  
208NIFA

---

**E** S6/S6/S6/S6/S6/S6/S6/  
S10/S10/S10/S10

---

**S** ~124x135

---

**M** 3 PCS **23%**

13 460

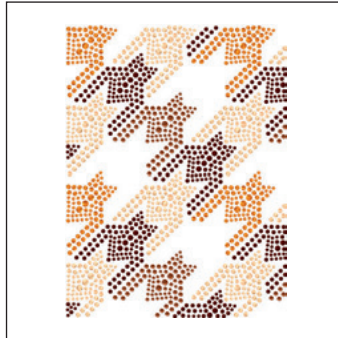

**C** R8012/R8012/R8012-001GSHA/  
203/1001/001GSHA/203/  
1001/001GSHA/203/1001/  
001GSHA/203/1001

---

**E** M2/M2.5/M3-S6/S6/S6/S8/S8/  
S8/S10/S10/S10/S16/S16

---

**S** ~130x172

---

**M** 3 PCS **18%**

13 461

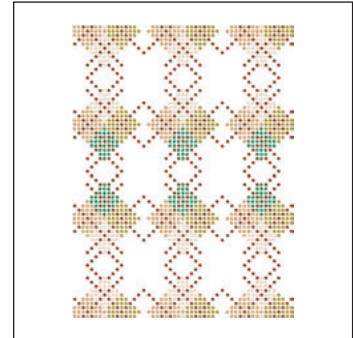

**C** 1001/246/1003/391/360

---

**E** S6/S6/S6/S6/S6

---

**S** ~129x172

---

**M** 3 PCS **18%**

13 462

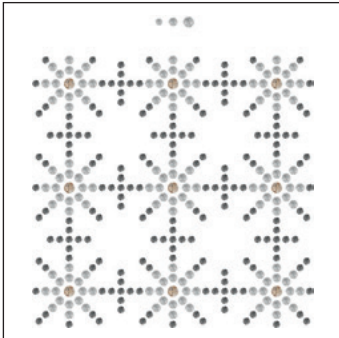

**C** 001GSHA/001/001SINI/  
001/001

---

**E** 1098SS20/1098SS20/1098PP24/  
1098PP24/1098PP31

---

**S** ~124x137

---

**M** 7 PCS **30%**

13 464

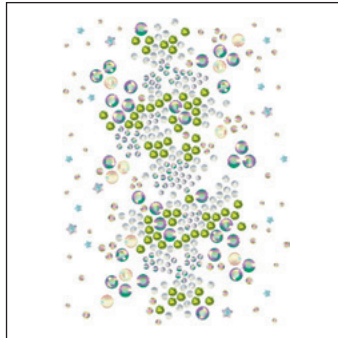

**C** 001TRAHFT/001L144D/  
001PARSH/001TRAHFT/234/  
001TRAHFT/337/001PARSH/  
001AB/202/001AB

---

**E** S8/S10/S12/S12/S16/S16/S20/  
S34/S34/2754MM4/2754MM6

---

**S** ~119x162

---

**M** 3 PCS **25%**

13 465

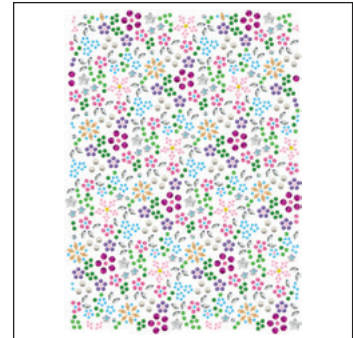

**C** R6018/R4005-001191/202/223/  
209/214/001PARSH/226/502/  
001AB/001AB/001/001GSHA

---

**E** M2/M2-P3/S3/S3/S6/S6/S6S6/  
S12/2200MM4X2/2754MM4/  
2754MM6/2201MM4.OX1.8

---

**S** ~111x153

---

**M** 3 PCS **28%**

13 466

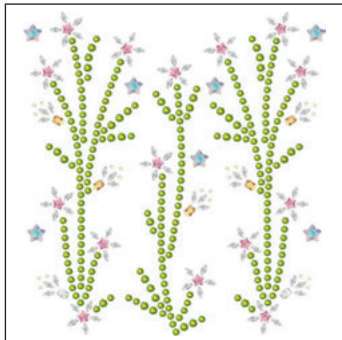

**C** 001AB/337/337/209/001AB/  
001GSHA/001AB/001

---

**E** S3/S8/S10/2754MM4/  
2754MM6/2602MM3.7X2.5/  
2602MM3.7X2.5/  
2201MM4.0X1.8

---

**S** ~99x107

---

**M** 4 PCS **40%**

13 467

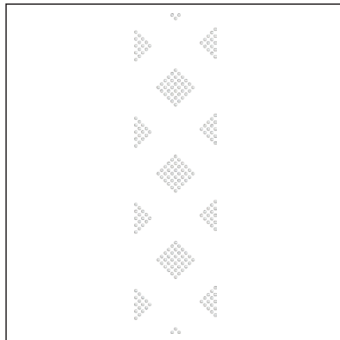

**C** 001650

---

**E** P2

---

**S** ~44x169

---

**M** 20 PCS **25%**

13 468

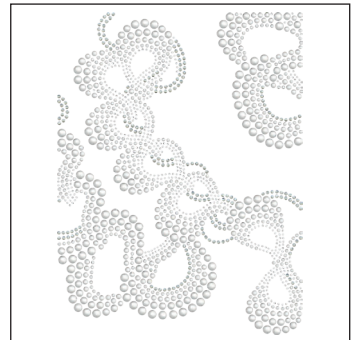

**C** 001650/001650/001650/  
001650/001/001MOL

---

**E** P3/P4/P2/P5/S3/S6

---

**S** ~130x170

---

**M** 3 PCS **25%**

Inspirational Motifs

13 469

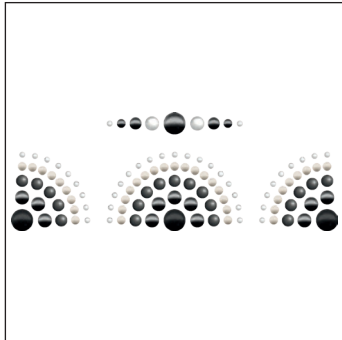

**C** 001191/280HEM/001617/  
280HEM/280/280HEM/001650/  
001650/280HEM/001650

---

**E** P3/P3/P4/P4/P7/P7/P2/P2/  
P5/P5

---

**S** ~105x38

---

**M** 16 PCS **41%**

13 470

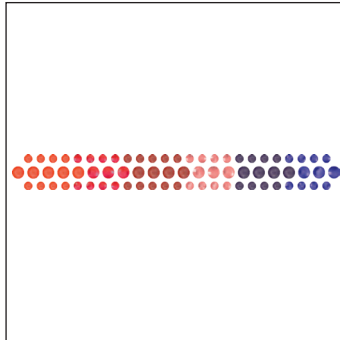

**C** 001L160I/001L159I/001L161I/  
539/542/257/001L159I/  
001L160I/001L161I/539/542/257

---

**E** S10/S10/S10/S10/S10/S10/  
S16/S16/S16/S16/S16/S16

---

**S** ~103x11

---

**M** 40 PCS **42%**

13 471

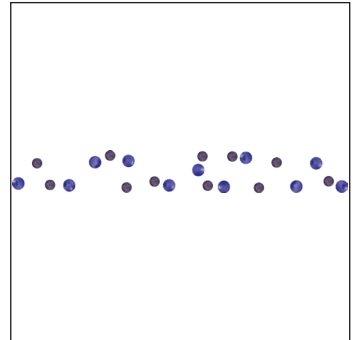

**C** 001L161I/539

---

**E** S16/S20

---

**S** ~122x16

---

**M** 49 PCS **29%**

13 472

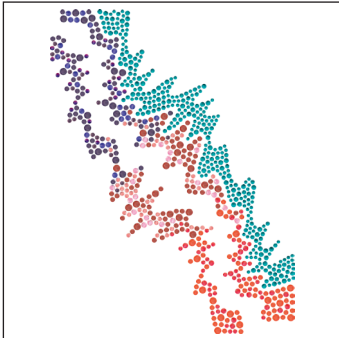

**C** 263/263/257/542/219/001VOL/  
263/001L160L/001L159I/  
001L161I/539/223/542/  
001L160L/001L161I/001L159I

**E** S6/S8/S8/S8/S8/S8/S10/S10/  
S10/S10/S12/S12/S12/S16/  
S16/S16

**S** ~129x172

**M** 5 PCS **20%**

13 473

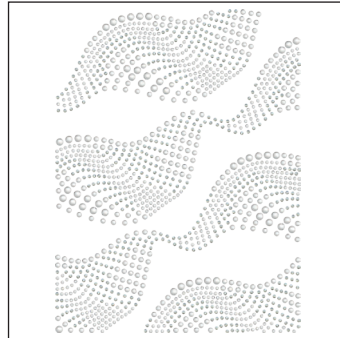

**C** 001650/001650/001650/  
001MOL

**E** P3/P4/P2/S6

**S** ~129x171

**M** 3 PCS **20%**

13 475

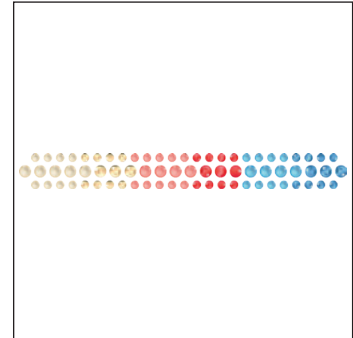

**C** 001L162I/001L164I/001L163I/  
211/261/262/001L164I/001L162I/  
001L163I/211/261/262

**E** S10/S10/S10/S10/S10/S10/  
S16/S16/S16/S16/S16/S16

**S** 103x11

**M** 40 PCS **42%**

13 476

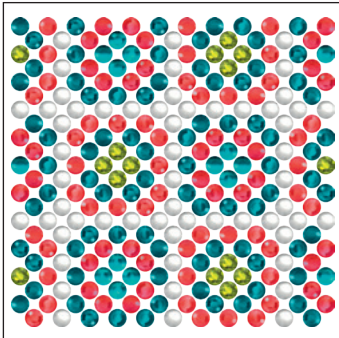

**C** 001650/229/262/542/337/263

**E** P7/S34/S34/S34/S34/S34

**S** ~126x120

**M** 3 PCS **34%**

13 477

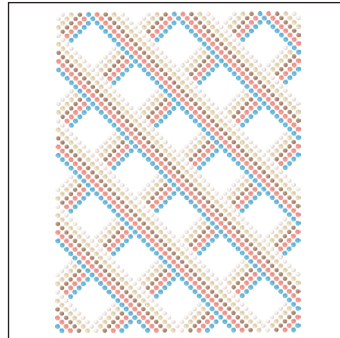

**C** R1019/R9003-001L164I/  
001L162I/001L163I

**E** M2.5/M2.5-S10/S10/S10

**S** ~129x170

**M** 3 PCS **25%**

13 478

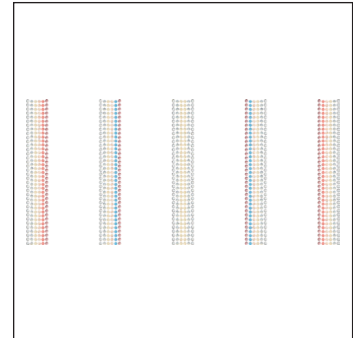

**C** 001650/001294/001L164I/234/  
391/001L162I/001L163I

**E** P3/P3/S10/S10/S10/S10/S10

**S** ~259x120

**M** 1 PCS **16%**

13 479

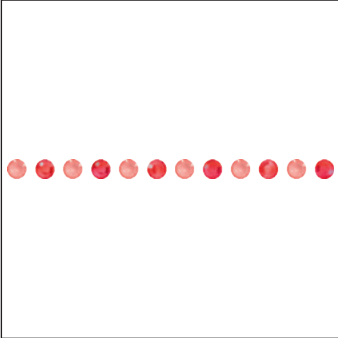

**C** 00111621/542/262  
**E** S16/S16/S16  
**S** ~966x4 (44 SEG/ROW)  
**M** 12 ROWS **67%**

13 480

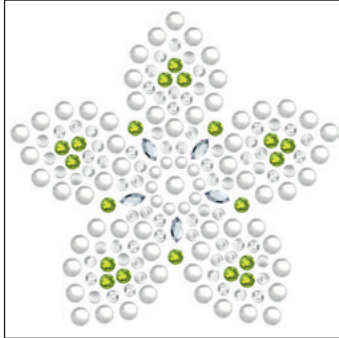

**C** 001650/001650/001/337/001  
**E** P3/P2/S6/S8/2200MM4x2  
**S** ~51x49  
**M** 21 PCS **85%**

13 481

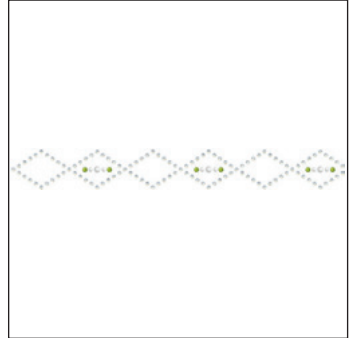

**C** 001650/001650/234/337  
**E** P3/P2/S6/S8  
**S** ~979x19 (18 SEG/ROW)  
**M** 7 ROWS **27%**

Inspirational Motifs

13 482

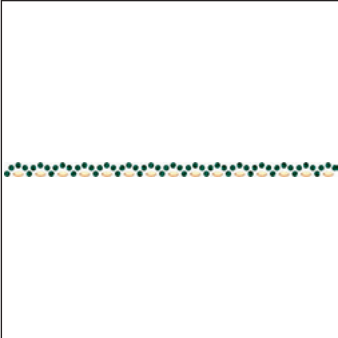

**C** 205/001GSHA  
**E** S6/2200MM4x2  
**S** ~985x5 (25 SEG/ROW)  
**M** 13 ROWS **37%**

13 483



**C** 001GSHA/001GSHA/215  
**E** S3/S8/2777MM5x4.2  
**S** ~472x6 (12 SEG/ROW)  
**M** 12 ROWS **37%**

13 484

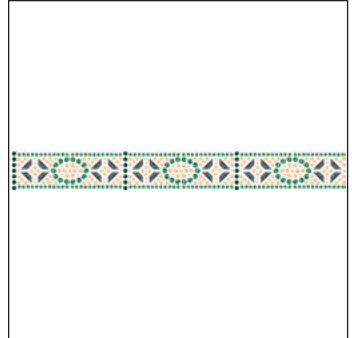

**C** 001GSHA/360/001GSHA/001GSHA/205/360/215  
**E** S3/S6/S6/S8/S8/S12/2772MM8.6x2.8  
**S** ~466x23 (7 SEG/ROW)  
**M** 6 ROWS **22%**

13 485

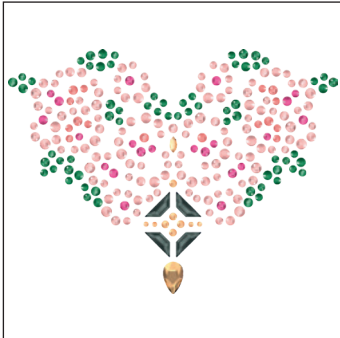

**C** 001GSHA/319/360/257/209/  
001GSHA/319/360/209/257/  
319/001GSHA/001GSHA/215

**E** S3/S6/S6/S6/S6/S6/S8/S8/  
S8/S8/S10/2303MM8x5/  
2200MM4x2/2772MM8.6x2.8

**S** ~81x60

**M** 15 PCS **54%**

13 486

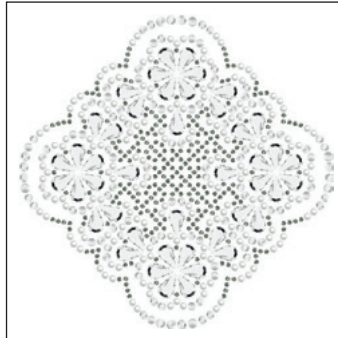

**C** 001650/001/215/001/001

**E** P2/CS8x5/S3/S8/S10

**S** ~92x92

**M** 10 PCS **45%**

13 487

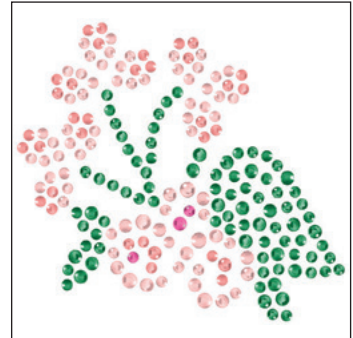

**C** 360/319/257/209/360/319/  
257/209/319

**E** S6/S6/S6/S6/S8/S8/S8/S8/S10

**S** ~56x51

**M** 28 PCS **77%**

13 488

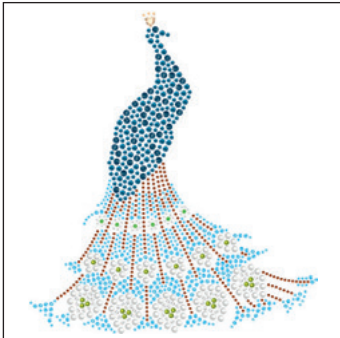

**C** 001650/202/1001/001/  
001GSHA/202/243NIFA/  
001/214/337/243NIFA/  
266/001GSHA

**E** P3/S3/S3/S3/S3/S6/S6/S6/  
S6/S8/S10/S12/2472MM5

**S** ~135x152

**M** 3 PCS **28%**

944269



**C** 280/001ITCH/001SINI/001/  
280HEM/215/215/001/253/  
280/253

**E** CS5x2.5/CS3x3/CS4x4/  
2555MM12x4/2400MM6/  
2772MM6.5x2.1/2772MM8.6x2.8/  
2777MM10x8.4/2472MM5/  
2472MM7/2472MM10

**S** ~95x122

**M** 4 PCS **35%**

944589

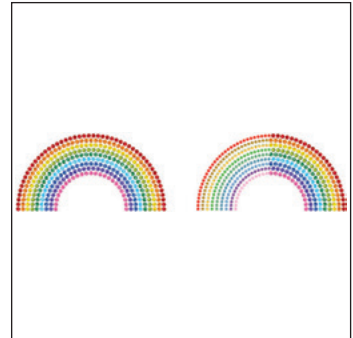

**C** 227/1003/001METSH/214/  
214SHIM/211SHIM/211/  
502SHIM/223/327/203/226/  
337/360/202/206/539/209

**E** S6/S6/S6/S6/S6/S6/S6/S6/  
S6/S10/S10/S10/S10/S10/  
S10/S10/S10/S10

**S** ~218x51

**M** 7 PCS **20%**

**944590**

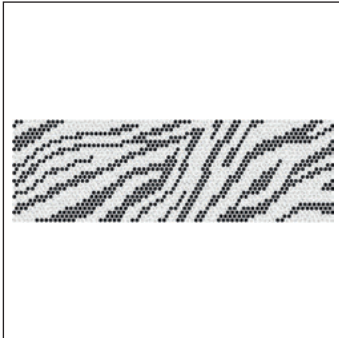

**C** 001/280  
**E** S6/S6  
**S** ~170x54  
**M** 15 PCS **25%**

**944591**

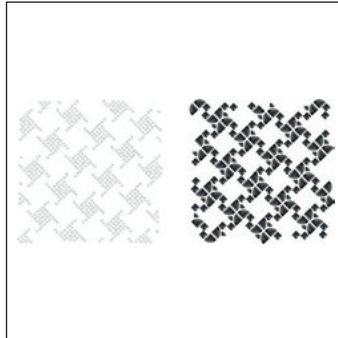

**C** 280/001/280/280  
**E** CS4x4/S6/2715MM30/  
2715MM60  
**S** ~220x100  
**M** 4 PCS **19%**

**944592**



**C** 280HEM/001/280HEM/001/  
001/001/001/001/280HEM/  
001SINI/001SSHA/280/253/  
253  
**E** P4/CS8x5/S10/2205MM7.5/  
2201MM8x3.5/2303MM8x5/  
2200MM4x2/2400MM2.2/  
2771MM6.4x4.2/2364MM6x3.7/  
2365MM6x3.7/2471MM5/  
2472MM5/2603MM4x3  
**S** ~154x45  
**M** 8 PCS **28%**

**944593**



**C** 001/001  
**E** S3/S6  
**S** ~378x112  
**M** 1 PCS **11%**

**944594**



**C** 001  
**E** PP7  
**S** ~228x8  
**M** 16 PCS **19%**

## SPECIAL MOTIF SERVICE

A special motif is any individual design created by the customer that differs to the Crystal Transfers Inspirational Collection. This service opens up an abundance of customization possibilities. You also no longer need to set your motif by hand. You can rely on Swarovski's long-standing experience and design expertise and can order a convenient, ready-to-apply design. A range of customization options for existing motifs is

### Customization Possibilities

- Change of elements in an existing motif
- Change of size of an existing motif
- Logos or brand names
- Your desired design
- Up to 18 elements or colors possible per Transfer motif

### Ordering Process

Send your request with the drawing you wish to order to your nearest Swarovski sales office. Make sure you include all measurements for the desired motif. Please also indicate which product group your special motif applies to (Crystal Transfers, Crystal-it, Crystal Mesh, etc.). You will then receive a quotation including your article number,

### Please Note

Please always submit the drawing of your desired motif to represent it in the actual size you require. A small sketch, when enlarged to the desired size, will have blurred lines that will make it difficult to correctly reproduce. Pictures or drawings representing 100% size of the design or very good quality scans in JPG, BMP, or DXF format will ensure that we have clear data to work with. These can also be sent via email. When the sketch is submitted as a copy by email, please include a scale legend (e.g. copy/scan

available (see "Customization Possibilities" below). You can also submit design sketches that meet your special requirements – such as a brand image or an image for a particular sales campaign or garment. This will then be made up according to your specifications using Computer Aided Design, which means that adjustments can be made easily according to your needs.

minimum order quantity, price, and the line drawing of your special motif in PDF format. Please contact your Swarovski sales office again if any changes are required. Your special motif will be produced and delivered following your confirmation.

with a ruler next to the drawing). This will ensure that the desired size of the motif can be identified.

Special productions are generally offered to all our customers if these are deemed to be feasible and comply with our General Terms and Conditions. Please note that ordering a design does not grant exclusive production of this design to the customer.

# Crystal-it Infinity

Crystal-it Infinity is made up of Flat Backs in different shapes, sizes, and colors. You may use up to 9 different elements per motif.

It is an easy-to-apply product thanks to the specially developed self-adhesive glue on the back of the stones. You can create your own individual and exclusive Crystal-it Infinity designs with Swarovski's special motif service.

## ARTICLE EXPLANATION

### 75 516



<b>C</b>	001/001SSHA/001SINI/280/280HEM
<b>E</b>	S6/S6/S6/CS3x3/CS3x3
<b>S</b>	~32x32 (TAPE : 75x53)
<b>M</b>	200 PCS <b>100%</b>

Crystal-it Infinity

75 516	C	E	S	M	100%
Article number	Color assortment	Elements	Motif size in mm	Minimum order quantity in pieces (PCS)	% of actual size
	For further details, please refer to the color and product charts at the beginning of this chapter. Color code 1 (001) corresponds to element 1 (S6); color code 2 (001SSHA) corresponds to element 2 (S6) etc.	For details of stone sizes and element codes, please refer to the color and product charts at the beginning of this chapter.	Size of the tape the motif is attached to in mm (TAPE)		

Please note: Due to their physical properties, Swarovski's self adhesive products are unsuitable for other uses such as gluing onto teeth, using on or near mucous membranes, and other unsafe uses.



## ORDERING EXAMPLE &amp; PRODUCT VARIETY EXPLANATION

75 516	022	001	001SSHA	001SINI	280
Article number	Carrier film color 022 White	Crystal color corresponding to element 1, color of most frequently used element in the motif.  Please see the respective color chart for all available reference codes.	Crystal color corresponding to element 2, color of second most frequently used element in the motif.	Crystal color corresponding to element 3, color of third most frequently used element in the motif.	Crystal color corresponding to element 4, color of fourth most frequently used element in the motif.

FLAT BACKS FOR CRYSTAL-IT INFINITY

Crystal-it Infinity

2038 XILION Rose

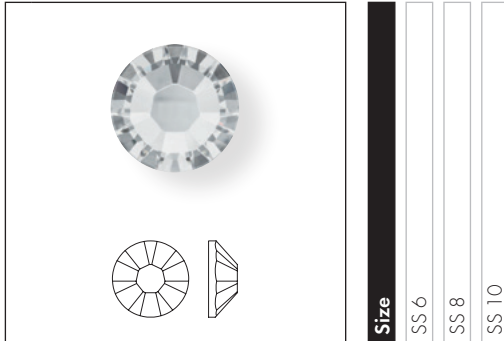

	Size	SS 6	SS 8	SS 10
<b>Crystal</b>				
Crystal (001)		■	■	■
<b>Colors</b>				
<b>Plain Colors</b>				
Amethyst (204)		■	■	■
Aquamarine (202)		■	■	■
Fuchsia (502)		■	■	■
Greige (284)		■	■	■
Indian Siam (327)		■	■	■
Jet (280)		■	■	■
Light Peach (362)		■	■	■
Light Rose (223)		■	■	■
Montana (207)		■	■	■
Peridot (214)		■	■	■
Sapphire (206)		■	■	■
Siam (208)		■	■	■
Tanzanite (539)		■	■	■
Topaz (203)		■	■	■
<b>Crystal Effects</b>				
<b>Transparent Effects</b>				
Crystal Aurore Boreale (001 AB)		■	■	■
Crystal Golden Shadow (001 GSHA)		■	■	■
Crystal Silver Night (001 SINI)		■	■	■
Crystal Silver Shade (001 SSHA)		■	■	■
<b>Metallic Effects</b>				
Crystal Light Chrome (001 LTCH)		■	■	■
<b>Color Effects</b>				
<b>Metallic Effects</b>				
Jet Hematite (280 HEM)		■	■	■

2078 XIRIUS Rose



	Size	SS 12	SS 16
<b>Crystal</b>			
Crystal (001)		■	■
<b>Colors</b>			
<b>Plain Colors</b>			
Amethyst (204)		■	■
Aquamarine (202)		■	■
Fuchsia (502)		■	■
Greige (284)		■	■
Indian Siam (327)		■	■
Jet (280)		■	■
Light Peach (362)		■	■
Light Rose (223)		■	■
Montana (207)		■	■
Peridot (214)		■	■
Sapphire (206)		■	■
Siam (208)		■	■
Tanzanite (539)		■	■
Topaz (203)		■	■
<b>Crystal Effects</b>			
<b>Transparent Effects</b>			
Crystal Aurore Boreale (001 AB)		■	■
Crystal Golden Shadow (001 GSHA)		■	■
Crystal Silver Night (001 SINI)		■	■
Crystal Silver Shade (001 SSHA)		■	■
<b>Metallic Effects</b>			
Crystal Light Chrome (001 LTCH)		■	■
<b>Color Effects</b>			
<b>Metallic Effects</b>			
Jet Hematite (280 HEM)		■	■

**2300 Drop Flat Back**

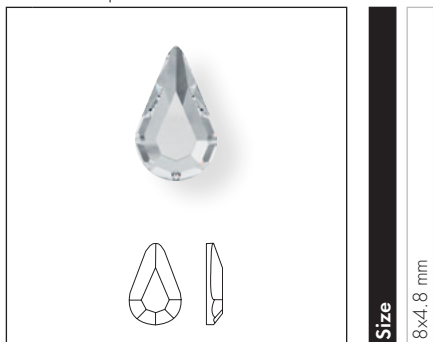

**Size**

8x4.8 mm

**Crystal**

Crystal (001)

**Colors**

**Plain Colors**

Jet (280)

**Crystal Effects**

**Transparent Effects**

Crystal Aurore Boreale (001 AB)

Crystal Golden Shadow (001 GSHA)

**2400 Square Flat Back**

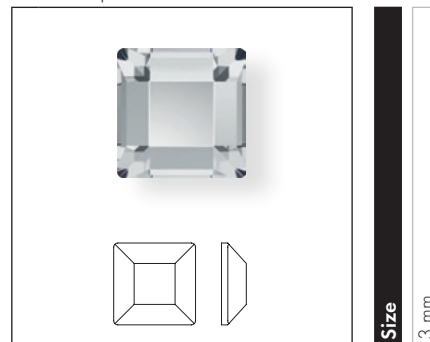

**Size**

3 mm

**Crystal**

Crystal (001)

**Colors**

**Plain Colors**

Jet (280)

**Crystal Effects**

**Transparent Effects**

Crystal Aurore Boreale (001 AB)

Crystal Golden Shadow (001 GSHA)

**Color Effects**

**Metallic Effects**

Jet Hematite (280 HEM)

### 2510 Baguette Flat Back

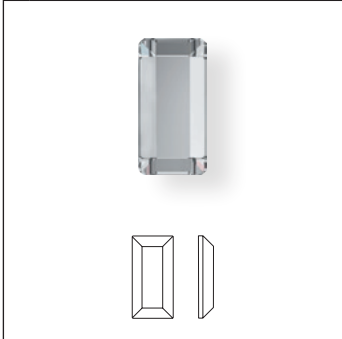

**Size**  
5x2.5 mm

**Crystal**

Crystal (001)

**Colors**

**Plain Colors**

Jet (280)

**Crystal Effects**

**Transparent Effects**

Crystal Aurore Boreale (001 AB)

Crystal-it Infinity

## INSPIRATIONAL MOTIFS

75 517

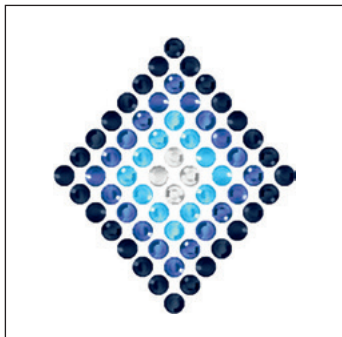

**C** 207/206/202/001  
**E** S10/S10/S10/S10  
**S** ~32x36 (TAPE : 75x53)  
**M** 200 PCS **100%**

75 519

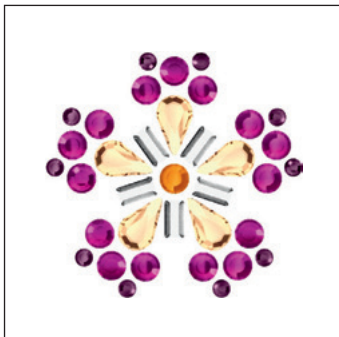

**C** 204/502/203/001GSHA/001  
**E** S8/S16T/S16T/CS8x5/CS5x2.5  
**S** ~34x32 (TAPE : 75x53)  
**M** 200 PCS **100%**

75 520



**C** 001GSHA/001GSHA/001GSHA/  
001GSHA  
**E** S6/S8/S10/CS8x5  
**S** ~56x42 (TAPE : 75x105)  
**M** 100 PCS **75%**

75 522

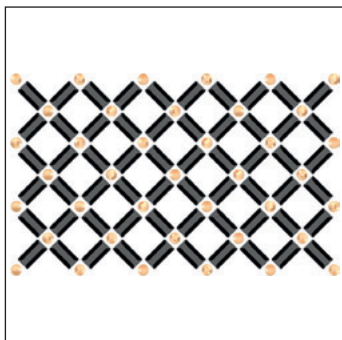

**C** 001GSHA/280  
**E** S6/CS5x2.5  
**S** ~58x35 (TAPE : 75x53)  
**M** 200 PCS **75%**

75 523

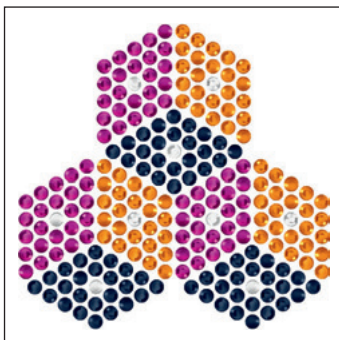

**C** 203/207/502/001  
**E** S6/S6/S6/S6  
**S** ~41x41 (TAPE : 75x105)  
**M** 100 PCS **100%**

## SPECIAL MOTIF SERVICE

A special motif is any individual design created by the customer that differs to the Self-adhesive Elements Standard or Crystal Inspirations Collections. This service opens up an abundance of customization possibilities and enables you to profit from Swarovski's long-standing experience and design expertise. A range of customization options for existing motifs is also available (see

"Customization Possibilities" below). You can also submit design sketches that meet your special requirements, such as a brand image or an image for a particular sales campaign. This will then be made up according to your specifications using Computer Aided Design, which means that adjustments can be made easily according to your needs.

### Customization Possibilities for Crystal-It Infinity

- Change of elements and colors of elements of an existing motif
- Change of size of an existing motif
- Logos or brand names
- Up to 9 different elements per motif are possible

### Ordering Process

Send your request with the drawing you wish to order to your nearest Swarovski sales office. Make sure you include all measurements for the desired motif. Please also indicate which product group your special motif applies to (Crystal-it, Crystal Fabric-it, Crystaltex-it, Crystaltex-it Chaton, Crystal Fine Rocks-it). You will then receive

a quotation including your article number, minimum order quantity, price, and the line drawing of your special motif in PDF format. Please contact your Swarovski sales office again if any changes are required. Your special motif will be produced and delivered following your confirmation.

### Please Note

Please always submit the drawing of your desired motif to represent it in the actual size you require. A small sketch, when enlarged to the desired size, will have blurred lines that will make it difficult to correctly reproduce. Pictures or drawings representing 100% size of the design or very good quality scans in JPG, BMP, or DXF format will ensure that we have clear data to work with. These can also be sent via email. If you are sending a sewing pattern, please include the whole pattern and not just sections. When the sketch is submitted as a copy by email, please include a scale legend (e.g. copy/scan with a ruler next to the drawing). This will ensure that the desired size of the motif can be identified.

Special productions are generally offered to all our customers if these are deemed to be feasible and comply with our General Terms and Conditions. Please note that ordering a design does not grant exclusive production of this design to the customer.

If detailed information on potential tolerances is needed (e.g. cavity production for metal parts), please contact Swarovski who will enter an application request into our application database.



# Crystal Textures

Our Crystal Textures solutions offer a uniquely differentiated look to unlock unlimited design potential.

Merging the sparkle and brilliance of crystals into integrated, harmonic designs they provide maximum customization flexibility, and highly personalized solutions that perfectly fit with our client needs in terms of design freedom, application differentiation, and technological advancement.

These versatile products combine elegant crystals from Swarovski with different gluing systems, each optimized for certain carrier materials and fields of application. Swarovski Crystal Textures solutions are ideal for use in the textiles, interior design, jewelry, DIY, and accessories segments, and offer numerous creative options.

Crystal Fabric is an inventive product, that consists of a carrier material that is completely covered with millions of tiny cut and uncut crystals.

Crystal Intarsia gives Crystal Textures a new level of radiance in sensational 3D looks, thanks to the fusion of Crystal Fabric, and Flat Backs.

Crystal Rocks, Crystal Fine Rocks and Crystal Ultrafine Rocks, are innovative, and stunning design elements that showcase different sizes of double-pointed chatons.

Through the implementation of Graphic technology, Crystal Fabric/ Ultrafine Rocks/Fine Rocks and Rocks undergo a remarkable transformation, converting any image into a dazzling array of crystals.

Offering a remarkable, innovative solution, Crystal Lacquered Foils transform any chosen Pantone hue into the Crystal Fabric and Crystal Rocks family, providing a perfect design color match.

Available in a wide range of colors and effects, Crystaltex Chaton Bandings craft luxurious fashion and design statements adding a touch of excitement to lavish ensembles.





# Crystal Textures

## AVAILABLE CRYSTAL TEXTURES PRODUCTS AND FIELDS OF APPLICATION

Crystal textures products offer a **unique, differentiated and new look**, which allows **endless design possibilities**.

Bringing together the sparkle and colors of Swarovski crystals, into integrated harmonic designs they provide **maximum customization flexibility**, and highly personalized solutions that perfectly fit with our client needs in terms of **design freedom, application differentiation and technological advancement**.

Different adhesive systems, already applied on the reverse side of the product, allow infinite application possibilities, optimized for each carrier material and field of application.

They are ideal for use in apparel and accessories segment, as well as in interior and tech segments.

Due to its outstanding bonding performance, Crystal textures products in **Hotfix** are perfect for a variety of textile applications with high performance requirements. Crystal textures products in **Coldfix** are developed especially for materials that are not suitable for Hotfix applications, such as real and artificial leather and functional fabrics.

Crystal Textures IT on the other hand, are ready to apply and perfect for solid materials such as paper, metal and glass, allowing easy and fast application.

Finally, **Removable foil** products, allow to apply and remove quickly the product onto solid surfaces such as metal, glass, plastic and artificial leather, for an effortless personalization.

Crystal Textures

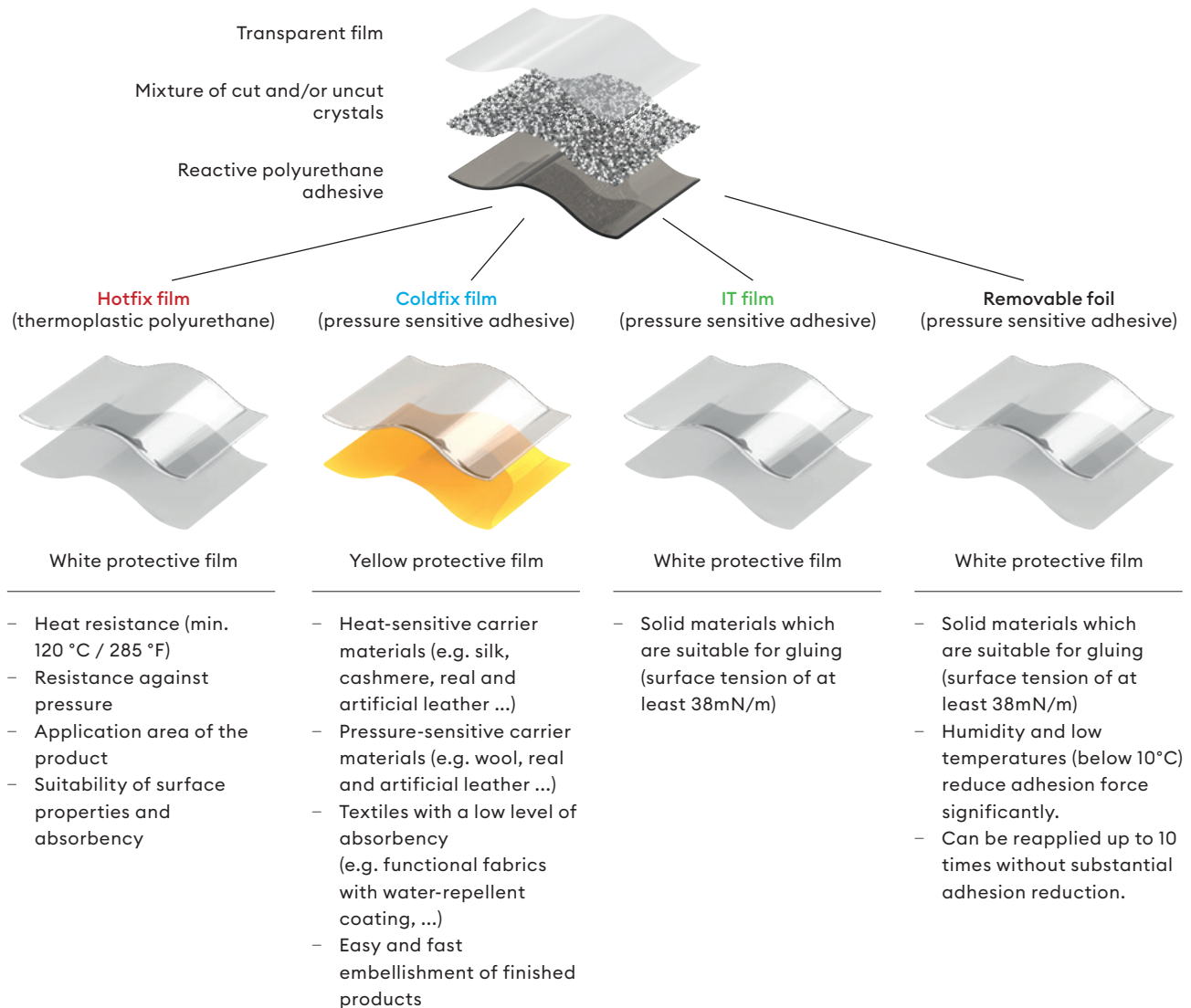

**Please keep in mind:** Coldfix is not a replacement for our Hotfix products – it is a new alternative for difficult carrier materials that are incompatible with Hotfix products.

If Hotfix is applicable, we recommend using Hotfix technique as the achievable bonding strength is higher than applying a Coldfix product.

Before beginning the application process, you should always check whether the carrier material is suitable for application of Self-adhesive Elements.

There are different material checks necessary, depending if you want to apply a Crystal textures product in **Hotfix** or a Crystal texture product in **IT** or **Removable Foil** on a **solid material** or a **Coldfix** product onto a **textile** or **leather carrier material**.

Nevertheless, please note that there are certain types of plastics used for **solid materials, textile and leather treatments** that are difficult for any gluing connection.

The following table contains a selection of materials that can cause problems for any glue application:

Plastic	Examples	Adhesive Qualities
Polyamide (PA)	Degamid, Nylon, Perlon	very difficult
Polyethylene (PE)	Geberit, Hostalen G, Ferrozell	difficult
Polyethylene Terephthalate (PET)	Cardura, Atlas, Eralyt	difficult
Polyoxymethylene (POM)	Delrin, Kematal, Ertacetal	difficult
Polypropylene (PP)	Moplefan, Proplex, Verelite	difficult
Polytetrafluoroethylene (PTFE)	Teflon®, Gaflon, Ferrotron	very difficult
SILICONE	Silopren, Contiduct, Corotex	very difficult

10

To increase the bonding strength of a **Coldfix** product or **Removable Foil** product onto leather surfaces, experience shows that in some cases it could be helpful to clean the carrier material with isopropyl alcohol before applying

the **Coldfix** product. We strongly recommend carrying out test to check if the carrier material does not get effected/damaged due to the alcohol.

To ensure the best possible result, test applications on the intended carrier material are strongly recommended. For information especially regarding material limitations please refer to our Application Manual.

# Crystal Fabric Bandings

## CRYSTAL FABRIC

Crystal Fabric is the most flexible crystallization solution on the market, offering a highly desirable, yet discrete sparkle at an entry price level!

Crystal fabric adds a luxurious touch to any product within a wide variety of segments, for example textiles,

accessories, jewelry, eyewear, and watches. Depending on the color and surface of the carrier material, Crystal Fabric with transparent film changes its look dramatically. Crystal Fabric on a black film creates a deep, mysteriously soft gleam, dressed up with a very alluring sparkle.

### Key features:

- Most discrete sparkle for your products, featuring a combination of extremely small unfaceted crystals and full-faceted crystals
- Thinnest and lightest solution
- Best for delicate fabrics
- Great for detailed graphic prints
- Possibility to create sharp edges for your design with the Unlimited option
- Perfect color match with the Crystal Lacquered Foils

## ARTICLE EXPLANATION

**57 000**



<b>C</b>	1010001 AB
<b>W</b>	001, 002, 003, 005, 010, 015
<b>M</b>	10 M <sup>1</sup> <b>100%</b>

<b>57 000</b>	<b>C</b>	<b>W</b>	<b>M</b>	<b>100%</b>
Article number	Color of crystals	Width of banding	Minimum order quantity in meters (M)	% of actual size

Crystal Fabric Bandings

## ORDERING EXAMPLE &amp; PRODUCT VARIETY EXPLANATION

57 000	002	I	010	001 AB
Article number	3-digit code for width	Type of base material	Color of base material	Color of crystals
	001 1 cm	Hotfix	010 Transparent	Please see the respective product matrix for all available reference codes.
	002 2 cm	C Coldfix*	012 Black	
	003 3 cm	I It version		
	005 5 cm	R Removable foil*		
	010 10 cm			
	015 15 cm			

\*Removable foil and coldfix are only available for motifs

<sup>1</sup> Please note: the 10-meter packing unit can be delivered in batches (max. three parts with a minimum length of 1 meter for each batch).

AVAILABLE BASE MATERIALS AND CRYSTAL COLORS & EFFECTS

57 000	Width in cm						Color of Film	
	001	002	003	005	010	015	010 Transparent (Hoflix; C_Coldfix*; Removable Foil*; _IT)	012 Black (Hoflix; C_Coldfix* _IT)
<b>Crystal Effects</b>								
<b>Transparent Effects</b>								
Crystal Aurore Boreale (001 AB)	■	■	■	■	■	■	■	■
Crystal Antique Pink (001 ANTP)	■	■	■	■	■	■	■	■
Crystal Golden Shadow (001 GSHA)	■	■	■	■	■	■	■	■
Crystal Heliotrope (001 HEL)	■	■	■	■	■	■	■	■
Crystal Moonlight (001 MOL)	■	■	■	■	■	■	■	■
Crystal Paradise Shine (001 PARSH)	■	■	■	■	■	■	■	■
<b>Metallic Effects</b>								
Crystal Chrome (001 CHRM)	■	■	■	■	■	■	■	■
Crystal Comet Argent Light (001 CAL)	■	■	■	■	■	■	■	■
Crystal Metallic Light Gold (001 MLGLD)	■	■	■	■	■	■	■	■
Crystal Metallic Sunshine (001 METSH)*	■	■	■	■	■	■	■	■
<b>Color Effects</b>								
<b>Metallic Effects</b>								
Jet Hematite (280 HEM)	■	■	■	■	■	■	■	■
<b>Multicolors</b>								
Crystal & Crystal Moonlight (001 M500)	■	■	■	■	■	■	■	■

\* Coldfix and Removable foil only available for motifs

\*\* Crystal Metallic Sunshine (001 METSH) is not suitable for swimwear because effect 001 METSH is highly sensitive to seawater, sweat, and chlorine.

<sup>1</sup> These colors and effects are available only for motifs, not bandings.

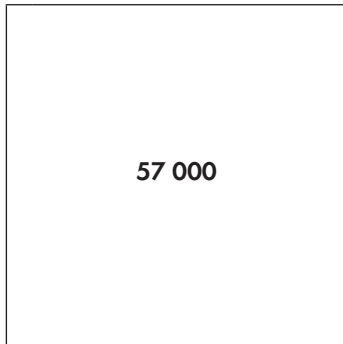

<b>Crystal Effects</b>
<b>Transparent Effects</b>
Crystal Aurore Boreale (001 AB)
Crystal Antique Pink (001 ANTP)
Crystal Golden Shadow (001 GSHA)
Crystal Heliotrope (001 HEL)
Crystal Moonlight (001 MOL)
Crystal Paradise Shine (001 PARSH)
<b>Metallic Effects</b>
Crystal Chrome (001 CHRM)
Crystal Comet Argent Light (001 CAL)
Crystal Metallic Light Gold (001 MLGLD)
Crystal Metallic Sunshine (001 METSH)**
<b>Color Effects</b>
<b>Metallic Effects</b>
Jet Hematite (280 HEM)
<b>Multicolors</b>
Crystal & Crystal Moonlight (001 M500)

Width in cm
001
002
003
005
010
015

Color of Film
Burgundy <sup>1</sup> (Hotfix; C_Coldfix*; Removable Foil*; _L_IT)
Laguna Emerald <sup>1</sup> (Hotfix; C_Coldfix*; Removable Foil*; _L_IT)
Light Coral <sup>1</sup> (Hotfix; C_Coldfix*; Removable Foil*; _L_IT)
Ocean Blue <sup>1</sup> (Hotfix; C_Coldfix*; Removable Foil*; _L_IT)
Pink <sup>1</sup> (Hotfix; C_Coldfix*; Removable Foil*; _L_IT)
Royal Red <sup>1</sup> (Hotfix; C_Coldfix*; Removable Foil*; _L_IT)
Electric Yellow <sup>1</sup> (Hotfix; C_Coldfix*; Removable Foil*; _L_IT)
Electric Blue <sup>1</sup> (Hotfix; C_Coldfix*; Removable Foil*; _L_IT)
Electric Pink <sup>1</sup> (Hotfix; C_Coldfix*; Removable Foil*; _L_IT)
Electric Violet <sup>1</sup> (Hotfix; C_Coldfix*; Removable Foil*; _L_IT)
Electric Orange <sup>1</sup> (Hotfix; C_Coldfix*; Removable Foil*; _L_IT)
Electric White <sup>1</sup> (Hotfix; C_Coldfix*; Removable Foil*; _L_IT)

The Crystal Lacquered Foils combine the shine of our Crystal Textures with customizable lacquer colors, opening up a new world of endless color possibilities. Transforming any chosen Pantone color in a new sparkling color variant for our Crystal Fabric and our Crystal Rocks family, they provide the best solution when looking for the perfect color match. They are ideal for monochromatic motifs with lower tolerances, improved color quality and maximum customization flexibility.

Standard colors are ready for reference. Customization possibilities are available through an inquiry to our Special motif service or through our Customer Service.

Please be aware that this unique technology cannot be combined with XS, Unlimited or Foil Overlay.

\* Coldfix and Removable foil only available for motifs  
 \*\* Crystal Metallic Sunshine (001 METSH) is not suitable for swimwear because effect 001 METSH is highly sensitive to seawater, sweat, and chlorine.  
<sup>1</sup> These colors and effects are available only for motifs, not bandings.

**OVERVIEW OF AVAILABLE COLORS & EFFECTS**

Crystal Aurore Boreale (001 AB)

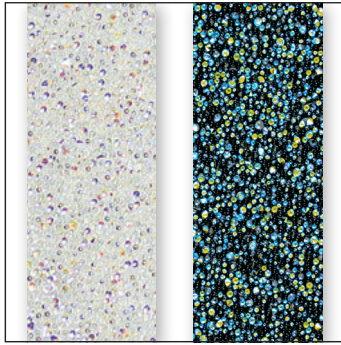

010 Transparent 012 Black

Crystal Antique Pink (001 ANTP)

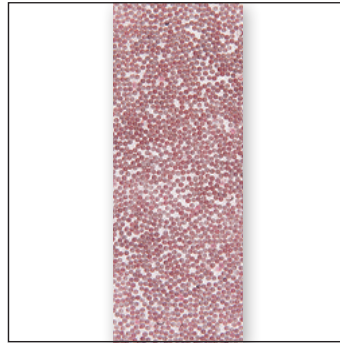

010 Transparent

Crystal Golden Shadow (001 GSHA)

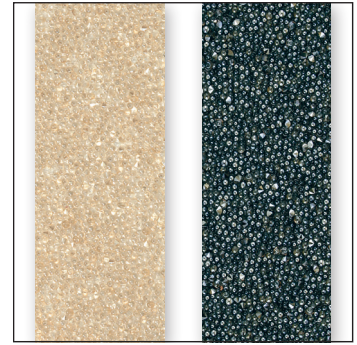

010 Transparent 012 Black

Crystal Heliotrope (001 HEL)



012 Black

Crystal Moonlight Blue (001 MOL)

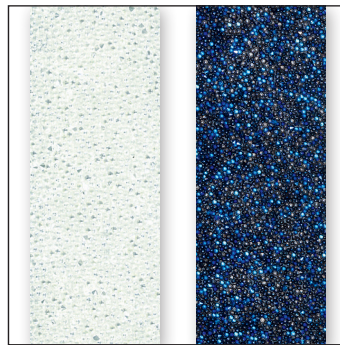

010 Transparent 012 Black

Crystal Paradise Shine (001 PARSH)



010 Transparent 012 Black

Crystal Chrome (001 CHRM)



010 Transparent 012 Black

Crystal Comet Argent Light (001 CAL)

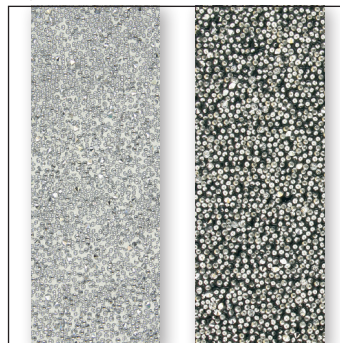

010 Transparent 012 Black

Crystal Metallic Light Gold (001 MLGLD)

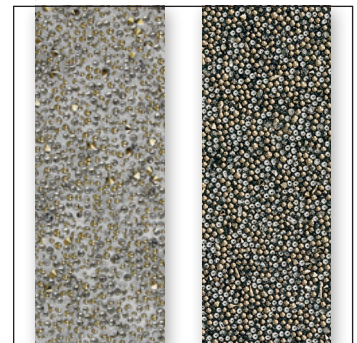

010 Transparent 012 Black

Crystal Fabric Bandings



Crystal Metallic Sunshine (001 METSH)

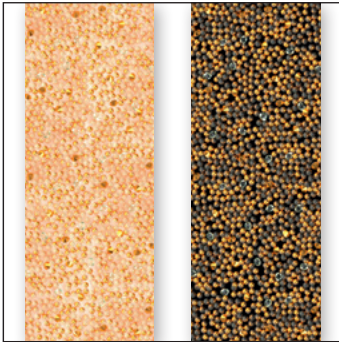

010 Transparent 012 Black

Jet HEM (280 HEM)



012 Black

Crystal & Crystal Moonlight (001 M500)

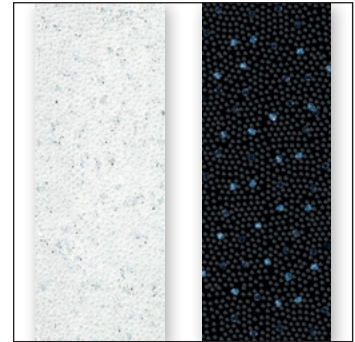

010 Transparent 012 Black

**Lacquered Foils colors**

Burgundy Foil<sup>1</sup>  
622F53

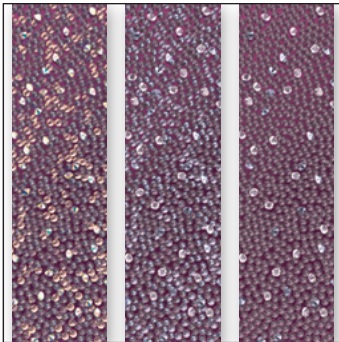

001 AB 001 MOL 001 M500

Laguna Emerald Foil<sup>1</sup>  
00958A

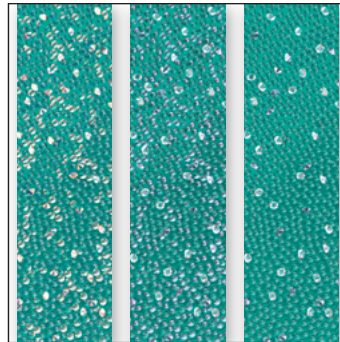

001 AB 001 MOL 001 M500

Light Coral Foil<sup>1</sup>  
F6624C

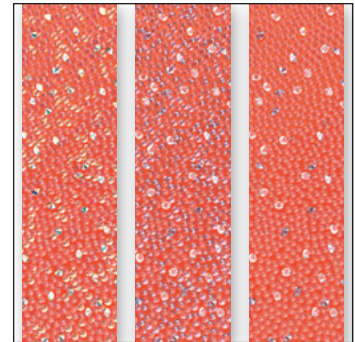

001 AB 001 MOL 001 M500

Ocean Blue Foil<sup>1</sup>  
4D7CBC

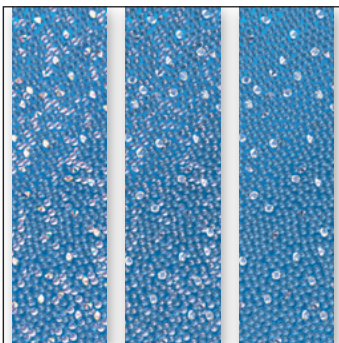

001 AB 001 MOL 001 M500

Pink Foil<sup>1</sup>  
ECB3CB

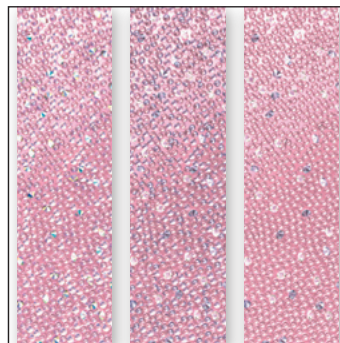

001 AB 001 MOL 001 M500

Royal Red Foil<sup>1</sup>  
B81B36

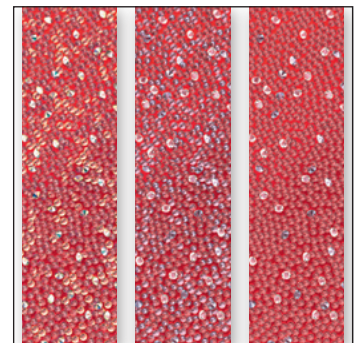

001 AB 001 MOL 001 M500

<sup>1</sup> These colors and effects are available only for motifs, not bandings.

**Lacquered Foils with Electric Lacquer<sup>PRO</sup> Effects**

Electric Yellow (001 L138S)<sup>1</sup>  
FFFF00

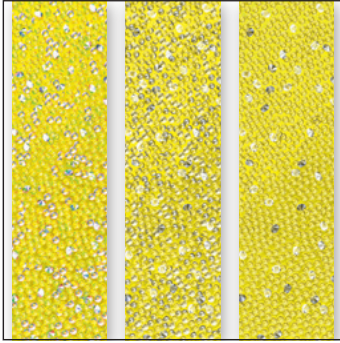

001 AB 001 MOL 001 M500

Electric Blue (001 L134S)<sup>1</sup>  
0097D6

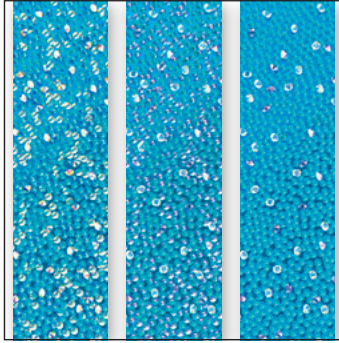

001 AB 001 MOL 001 M500

Electric Pink (001 L137S)<sup>1</sup>  
FF4FB1

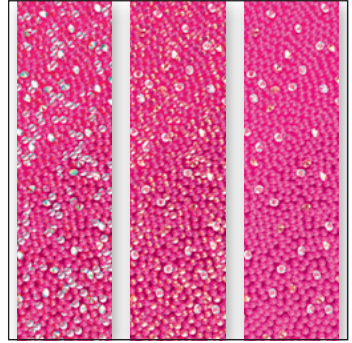

001 AB 001 MOL 001 M500

Electric Violet (001 L148S)<sup>1</sup>  
AB61C0

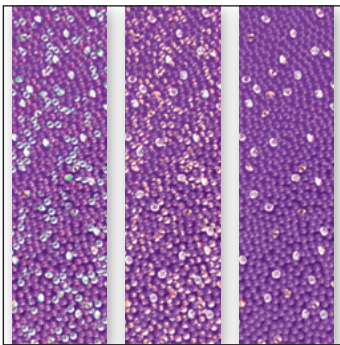

001 AB 001 MOL 001 M500

Electric Orange (001 L136S)<sup>1</sup>  
FF5557

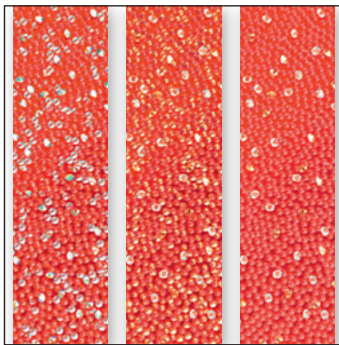

001 AB 001 MOL 001 M500

Electric White (001 L139S)<sup>1</sup>  
D8DEE9

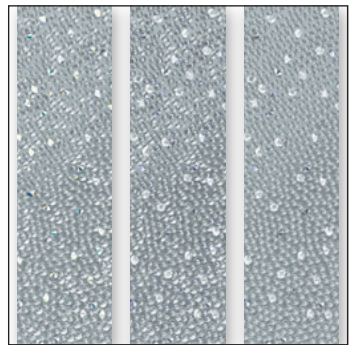

001 AB 001 MOL 001 M500

<sup>1</sup>These colors and effects are available only for motifs, not bandings.

# Crystal Fabric Inspirational Motifs

## ARTICLE EXPLANATION

57 393

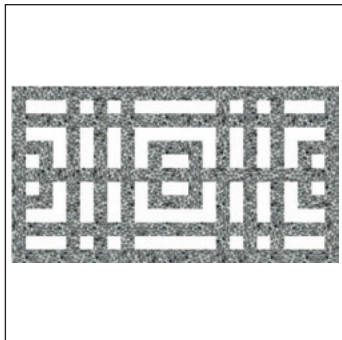

**C** C010001CAL  
**S** ~72x39  
**M** 76 PCS **60%**

57 393	C	S	M	60%
Article number	Color of crystals	Motif size in mm	Minimum order quantity in pieces (PCS)	% of actual size

10

## ORDERING EXAMPLE & PRODUCT VARIETY EXPLANATION

57 393	I	012	001CAL
Article number	Type of base material	Color of base material	Color of crystals Please see the respective product matrix for all available reference codes.
	Hotfix	010 Transparent	
	H Hotfix for Lacquered Foils	012 Black	
	C Coldfix		
	I It version		
	R Removable foil		

INSPIRATIONAL MOTIFS

57 335

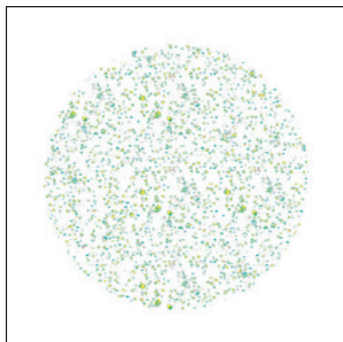

C 010-001AB  
S ~35x35  
M 147 PCS 100%

57 345

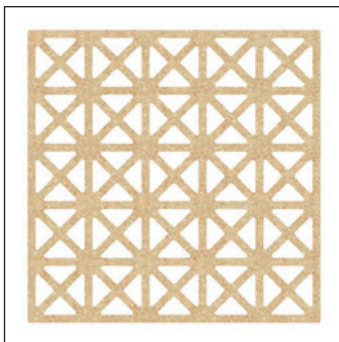

C 010-001GSHA  
S ~110x110  
M 16 PCS 35%

57 392

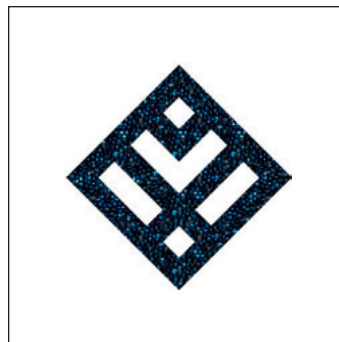

C C012-001MOL  
S ~30x30  
M 300 PCS 100%

Crystal Fabric Inspirational Motifs

57 393

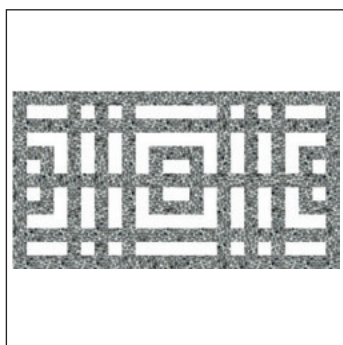

C C010-001CAL  
S ~72x39  
M 76 PCS 60%

57 412

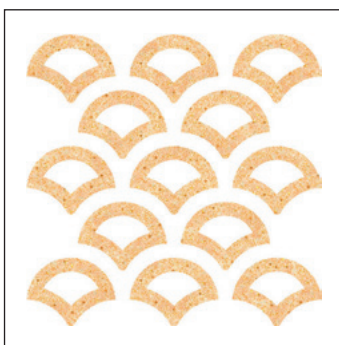

C 010-001METSH  
S ~65x64  
M 52 PCS 60%

57 422



C 010-001ANTP  
S ~305x152  
M 6 PCS 14%

57 423

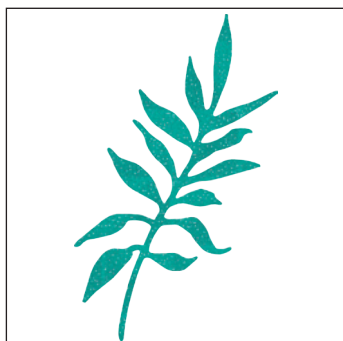

C H00958A-001M500  
S ~107x172  
M 18 PCS 100%

57 434

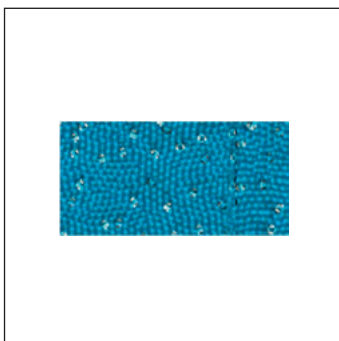

C H0097D6 001M500  
S 30x15  
M 130 PCS 100%

57 437

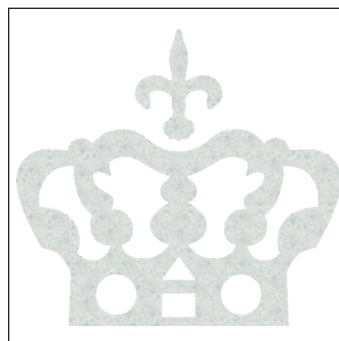

C 010-001M500  
S ~107x98  
M 27 PCS 40%

Please note: all motifs are available in certain color/film variations (see color matrix).

## SPECIAL MOTIF SERVICE

A special motif is any individual design created by the customer that differs to the Crystal Fabric Inspirational or Special Collections. This service opens up an abundance of customization possibilities and enables you to profit from Swarovski's long-standing experience and design expertise. A range of customization options for existing motifs is available (see "Customization Possibilities" below).

### Customization Possibilities for Crystal Fabric

- Min. motif size: of 10x10 mm or effective surface of 1 cm<sup>2</sup>
- Min. width of gaps within motifs: 3 mm
- Min. Crystal Fabric surface: 3 mm
- Min. size of the smallest element within a motif: 10x10 mm or effective area of 1 cm<sup>2</sup>

### Ordering Process

Send your request with the drawing you wish to order to your nearest Swarovski sales office. Make sure you include all measurements for the desired motif. Please also indicate which product group your special motif applies to (Crystal Fabric). You will then receive a quotation including

You can also submit design sketches that meet your special requirements, such as a brand image or an image for a particular sales campaign. This will then be made up according to your specifications using Computer Aided Design, which means that adjustments can be made easily according to your needs.

your article number, minimum order quantity, price, and the line drawing of your special motif in PDF format. Please contact your Swarovski sales office again if any changes need to be made. Your special motif will be produced and delivered following your confirmation.

### Please Note

Please always submit the drawing of your desired motif to represent it in the actual size you require. A small sketch, when enlarged to the desired size, will have blurred lines that will make it difficult to correctly reproduce. Pictures or drawings representing 100% size of the design or very good quality scans in JPG, BMP, or DXF format will ensure that we have clear data to work with. These can also be sent via email. If sending a sewing pattern, please include the whole pattern and not just sections. When the sketch is submitted as a copy by email, please include a scale legend (e.g. copy/scan with a ruler next to the drawing). This will ensure that the desired size of the motif can be identified.

It is generally possible to draw motifs with a minimum gap of 3 mm between the outlines. However, due to the tolerance level of the crystals being applied onto carrier film, the final Crystal Fabric motifs may differ from the sketches or prints in relation to the motifs'

outline, especially with spaces that are smaller than 3 mm. Therefore the motif, and by extension, the product itself, may be subject to individual variations with each reproduction. These variations are caused by technical production-related factors. As these variations are not deemed to be defects, warranty claims are excluded and Swarovski assumes no liability whatsoever in connection with them.

Special productions are generally offered to all our customers if these are deemed to be feasible and comply with our General Terms and Conditions. Please note that ordering of a design does not grant exclusive production of this design to the customer.

If detailed information on possible tolerances is required (e.g. cavity production for metal parts), please contact your local Swarovski sales office who will enter an application request into our application database.

# Crystal Intarsia

Unique on the market, Intarsia gives Crystal Textures a new level of radiance and contemporary cool in sensational 3D looks. With its boldly chic new approach to next-level fabulous, the fusion of Crystal Fabric and Flat Backs is not only innovative, but also easy to apply, advancing the spectacular effect of radiant tactility. To further enhance the possibility to create 3D and stunning

designs, Crystal Intarsia can be combined with the graphic printing technology. Celebrating the increasing focus on cross-cultural creativity, heritage and patterning among the young, it heralds an appreciation of beautiful craftsmanship. Perfect for repeating radiant patterns, Crystal Intarsia answers the designer’s dream of creating an eclectic, multicultural vibe in a fabulous new format.

**Key features:**

- A mix of Crystal Fabric and Flat Backs
- Possibility to combine with Graphic Foil Print
- Enhanced Tactility
- Luxurious look and feel

**ARTICLE EXPLANATION**

**84 034**

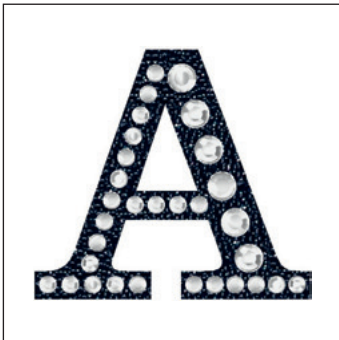

<b>C</b>	012-280HEM/001/001
<b>E</b>	S8/S16
<b>S</b>	~36x33
<b>M</b>	64 PCS <b>100%</b>

Crystal Intarsia

84 034	C	E	S	M	90%
Article number	Color of crystals	Elements  For details of stone sizes and element codes, please refer to the color and product charts in the next pages of this chapter.	Motif size in mm	Minimum order quantity in pieces (PCS)	% of actual size

## ORDERING EXAMPLE &amp; PRODUCT VARIETY EXPLANATION

84 034	I	010	001 CAL
Article number	Type of base material	Color of base material	Color of crystals
	Hotfix	010 Transparent	Please see the respective product matrix for all available reference codes.
	H Hotfix for Lacquered Foils	012 Black	
	C Coldfix		
	I It version		
	R Removable foil		

**CRYSTAL FLAT BACKS FOR INTARSIA**

**2038 XILION Rose Half**

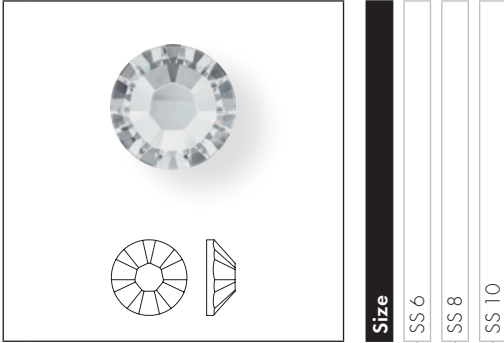

Size	SS 6	SS 8	SS 10
------	------	------	-------

Crystal	SS 6	SS 8	SS 10
Crystal A HF (001)	■	■	■
<b>Colors</b>			
<b>Plain Colors</b>			
Amethyst A HF (204)	■	■	■
Aquamarine A HF (202)	■	■	■
Black Diamond A HF (215)	■	■	■
Denim Blue A HF (266)	■	■	■
Emerald A HF (205)	■	■	■
Erinite A HF (360)	■	■	■
Fuchsia A HF (502)	■	■	■
Indian Siam A HF (327)	■	■	■
Jet A HF (280)	■	■	■
Jonquil A HF (213)	■	■	■
Light Amethyst A HF (212)	■	■	■
Light Peach A HF (362)	■	■	■
Light Rose A HF (223)	■	■	■
Light Sapphire A HF (211)	■	■	■
Light Siam A HF (227)	■	■	■
Light Silk A HF (261)	■	■	■
Light Turquoise A HF (263)	■	■	■
Majestic Blue A HF (296)	■	■	■

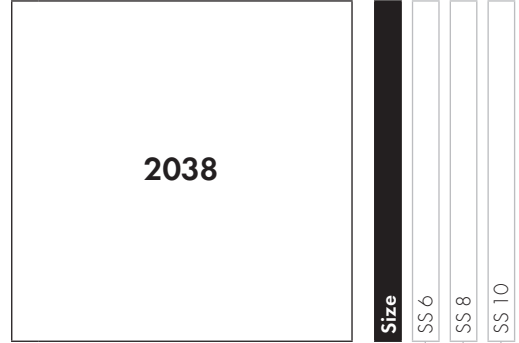

Size	SS 6	SS 8	SS 10
------	------	------	-------

Crystal	SS 6	SS 8	SS 10
Montana A HF (207)	■	■	■
Peridot A HF (214)	■	■	■
Rose A HF (209)	■	■	■
Ruby A HF (501)	■	■	■
Sapphire A HF (206)	■	■	■
Scarlet A HF (276)	■	■	■
Siam A HF (208)	■	■	■
Silk A HF (391)	■	■	■
Tanzanite A HF (539)	■	■	■
Vintage Rose A HF (319)	■	■	■
<b>Crystal Effects</b>			
<b>Transparent Effects</b>			
Crystal AB A HF (001 AB)	■	■	■
Crystal Golden Shadow A HF (001 GSHA)	■	■	■
Crystal Metallic Sunshine A HF (001 METSH)	■	■	■
Crystal Moonlight A HF (001 MOL)	■	■	■
Crystal Silver Night A HF (001 SINI)	■	■	■
Crystal Silver Shade A HF (001 SSHA)	■	■	■
<b>Crystal Effects</b>			
<b>Transparent Effects</b>			
Jet Hematite A HF (280 HEM)	■	■	■

Crystal Intarsia

Crystal Intarsia is not suitable for swimwear because it is highly sensitive to seawater, sweat, and chlorine.



2078 XIRIUS Rose Hoflix

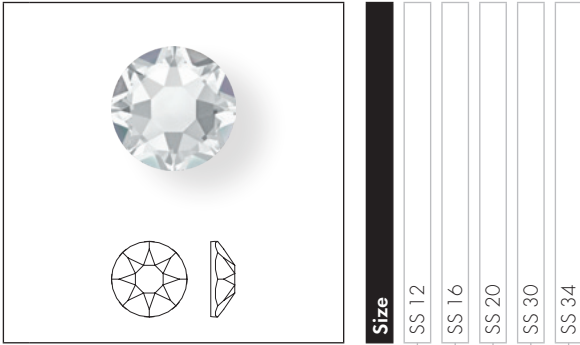

Crystal	SS 12	SS 16	SS 20	SS 30	SS 34
Crystal A HF (001)	■	■	■	■	■
<b>Colors</b>					
<b>Plain Colors</b>					
Amethyst A HF (204)	■	■	■	■	■
Aquamarine A HF (202)	■	■	■	■	■
Black Diamond A HF (215)	■	■	■	■	■
Denim Blue A HF (266)	■	■	■	■	■
Emerald A HF (205)	■	■	■	■	■
Erinte A HF (360)	■	■	■	■	■
Fuchsia A HF (502)	■	■	■	■	■
Indian Siam A HF (327)	■	■	■	■	■
Jet A HF (280)	■	■	■	■	■
Jonquil A HF (213)	■	■	■	■	■
Light Amethyst A HF (212)	■	■	■	■	■
Light Peach A HF (362)	■	■	■	■	■
Light Rose A HF (223)	■	■	■	■	■
Light Sapphire A HF (211)	■	■	■	■	■
Light Siam A HF (227)	■	■	■	■	■
Light Silk A HF (261)	■	■	■	■	■
Light Turquoise A HF (263)	■	■	■	■	■
Majestic Blue A HF (296)	■	■	■	■	■
Montana A HF (207)	■	■	■	■	■
Peridot A HF (214)	■	■	■	■	■
Rose A HF (209)	■	■	■	■	■
Ruby A HF (501)	■	■	■	■	■
Sapphire A HF (206)	■	■	■	■	■
Scarlet A HF (276)	■	■	■	■	■
Siam A HF (208)	■	■	■	■	■
Silk A HF (391)	■	■	■	■	■
Tanzanite A HF (539)	■	■	■	■	■
Vintage Rose A HF (319)	■	■	■	■	■



Crystal Effects	SS 12	SS 16	SS 20	SS 30	SS 34
<b>Transparent Effects</b>					
Crystal AB A HF (001 AB)	■	■	■	■	■
Crystal Golden Shadow A HF (001 GSHA)	■	■	■	■	■
Crystal Metallic Sunshine A HF (001 METSH)*	■	■	■	■	■
Crystal Moonlight A HF (001 MOL)	■	■	■	■	■
Crystal Silver Night A HF (001 SINI)	■	■	■	■	■
Crystal Silver Shade A HF (001 SSHA)	■	■	■	■	■
<b>Crystal Lacquer<sup>PRO</sup> Effects</b>					
<b>Crystal Electric Lacquer<sup>PRO</sup> Effects</b>					
Crystal Electric Blue (001 L134S)	■	■	■	■	■
Crystal Electric Green (001 L135S)	■	■	■	■	■
Crystal Electric Orange (001 L136S)	■	■	■	■	■
Crystal Electric Pink (001 L137S)	■	■	■	■	■
Crystal Electric Violet (001 L148S)	■	■	■	■	■
Crystal Electric White (001 L139S)	■	■	■	■	■
Crystal Electric Yellow (001 L138S)	■	■	■	■	■
<b>Crystal Effects</b>					
<b>Transparent Effects</b>					
Jet Hematite A HF (280 HEM)	■	■	■	■	■

Crystal Intarsia is not suitable for swimwear because it is highly sensitive to seawater, sweat, and chlorine.

**CRYSTAL FABRIC FOR INTARSIA**

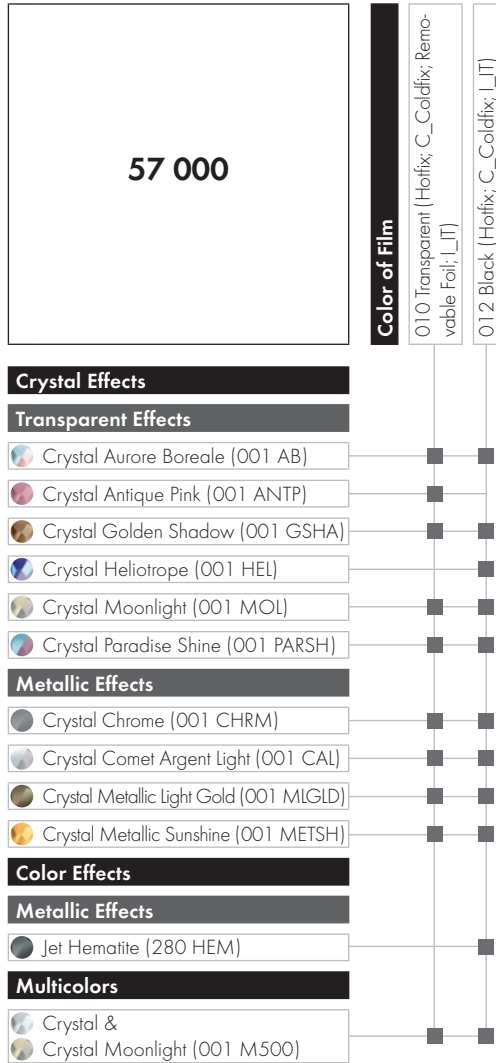

Crystal Intarsia

**GRAPHIC FABRIC FOR INTARSIA**

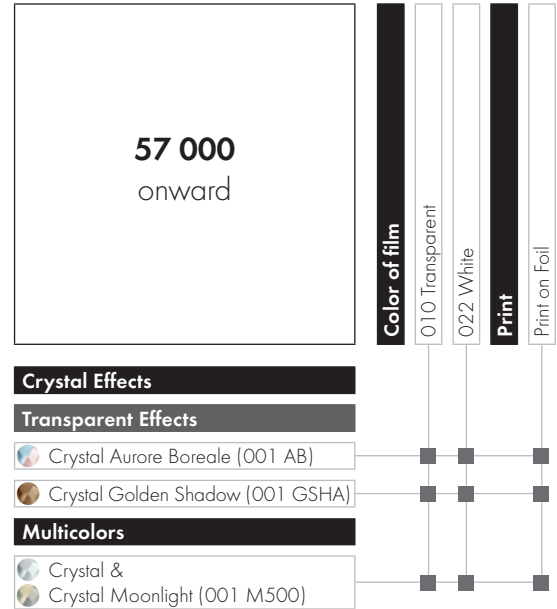

Crystal Intarsia is only available for motifs.

Crystal Intarsia is not suitable for swimwear because it is highly sensitive to seawater, sweat, and chlorine.

## INSPIRATIONAL MOTIFS

84 034

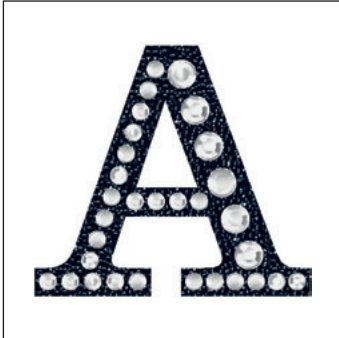

C 012-280HEM/001/001  
 E S8/S16  
 S ~36x33  
 M 64 PCS **100%**

84 035

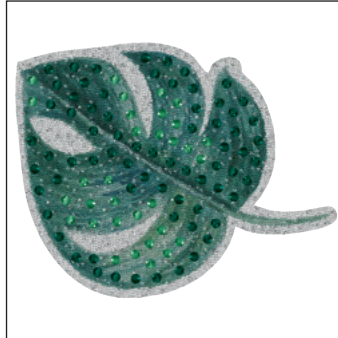

C 022-FP24889 001M500/205/360  
 E S10/S10  
 S ~88x70  
 M 16 PCS **48%**

84 036



C 022-FP24328 001M500/213/  
 360/213/360  
 E S6/S6/S10/S10  
 S ~50x41  
 M 56 PCS **88%**

84 037



C 022-FP24894 001M500/202/  
 227/208/001  
 E S6/S6/S6/S6  
 S ~96x96  
 M 9 PCS **44%**

84 040

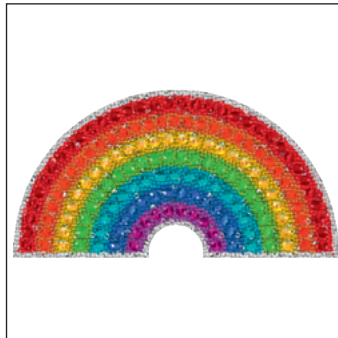

C 022-FP24916 001M500/327/227/  
 001METSH/214/263/206/502  
 E S6/S6/S6/S6/S6/S6/S6/  
 S ~57x30  
 M 50 PCS **75%**

84 043

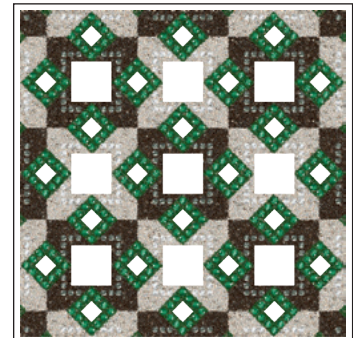

C 022-FP24955 001GSHA/001/  
 215/360  
 E S6/S6/S8  
 S ~102x102  
 M 9 PCS **42%**

84 044



C 022-FP27189 001M500/  
 001L134S/001L138S  
 E S12/S12  
 S ~105x127  
 M 9 PCS **33%**

84 045



C 022-FP27190 001M500/296/  
 001L137S  
 E S8/S12  
 S ~105x127  
 M 9 PCS **33%**

84 046



C 022-FP27097 001M500/001AB/  
 213/501/001METSH/214/213/  
 001L138S/208/501  
 E S6/S6/S6/S8/S10/S10/S12/  
 S20/S34  
 S ~105x127  
 M 9 PCS **33%**

**84 047**

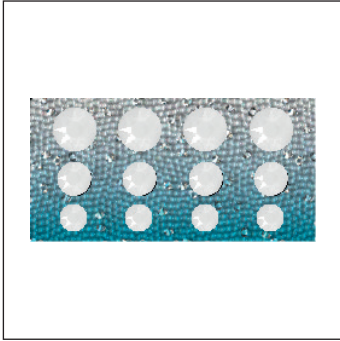

**C** 022-FP26043 001M500/001L139S/  
001L139S/001L139S  
**E** S12/S16/S20  
**S** ~30x15  
**M** 130 PCS **100%**

**84 051**

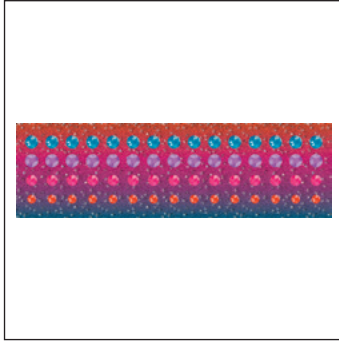

**C** 022-001M500/001L136S/  
001L137S/001L134S/001L148S  
**E** S12/S16/S20/S20  
**S** ~111x33  
**M** 24 PCS **30%**

**84 052**

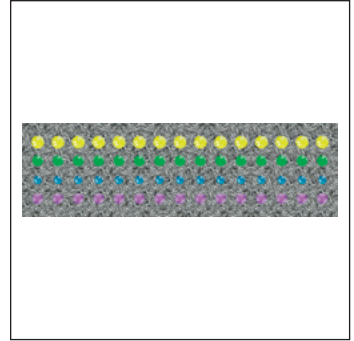

**C** 010-001CAL/001L134S/  
001L135S/001L148S/001L138S  
**E** S12/S16/S16/S20  
**S** ~111x33  
**M** 24 PCS **30%**

**84 053**



**C** 012-280HEM/280/280/280/  
280/280  
**E** S6/S8/S12/S16/S20  
**S** ~46x63  
**M** 42 PCS **65%**

**84 054**

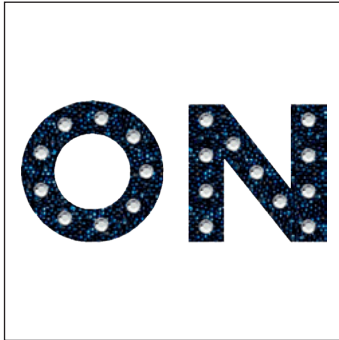

**C** 012-001MOL/001  
**E** S6  
**S** ~40x19  
**M** 98 PCS **100%**

**84 055**

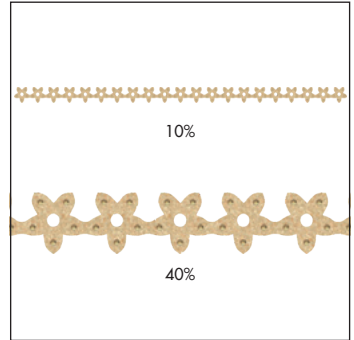

**C** 010-001GSHA/001GSHA  
**E** S6  
**S** ~397x20  
**M** 11 PCS

## SPECIAL MOTIF SERVICE

A special motif is any individual design created by the customer that differs to the Crystal Intarsia Inspirational or Special Collections. This service opens up an abundance of customization possibilities and enables you to profit from Swarovski's longstanding experience and design expertise. A range of customization options for existing motifs is available (see "Customization Possibilities" below).

### Customization Possibilities for Crystal Intarsia

- Max. motif size 400 x 330 mm
- Min. motif size of 10 x 10 mm or effective surface of 1.0 cm<sup>2</sup>
- Min. width of gaps within motifs: 3 mm
- Min. Crystal Intarsia surface: 3 mm

### Ordering Process

Send your request with the drawing you wish to order to your nearest Swarovski sales office. Make sure you include all measurements for the desired motif. Please also indicate which product group your special motif applies to (Crystal Intarsia). You will then receive a quotation

### Please Note

Please always submit the drawing of your desired motif to represent it in the actual size you require. A small sketch, when enlarged to the desired size, will have blurred lines that will make it difficult to correctly reproduce. Pictures or drawings representing 100% size of the design or very good quality scans in JPG, BMP, or DXF format will ensure that we have clear data to work with. These can also be sent via email. If sending a sewing pattern, please include the whole pattern and not just cut-outs. If the sketch is submitted as a copy by e-mail, please include a scale legend (e.g. copy/scan with ruler next to the drawing). This will ensure that the desired size of the motif can be identified.

It is generally possible to draw motifs with a minimum gap of 3 mm between the outlines. However, due to the tolerance level of the crystals being applied onto carrier film, the final Crystal Intarsia Motifs may differ from the sketches or prints in relation to the motifs'

You can also submit design sketches that meet your special requirements – such as a brand image or an image for a particular sales campaign. This will then be made up according to your specifications using Computer Aided Design, which means that adjustments can be made easily according to your needs.

- Min. size of the smallest element within a motif: 10x10 mm or effective surface of 1.0 cm<sup>2</sup>
- Maximum amount of different colors/sizes of crystals: 9 different flat back elements + 1 Crystal Fabric mixture color + 1 carrier foil color

including your article number, minimum order quantity, price, and the line drawing of your special motif in PDF format. Please contact your Swarovski sales office again if any changes need to be made. Your special motif will be produced and delivered following your confirmation.

outline, especially with spaces that are smaller than 3mm. Therefore, the motif, and by extension, the product itself, may be subject to individual variations with each reproduction. These variations are caused by technical production-related factors. As these variations are not deemed to be defects, warranty claims are excluded, and Swarovski assumes no liability whatsoever in connection with them.

Special productions are generally offered to all our customers if these are deemed to be feasible and comply with our General Terms and Conditions. Please note that ordering of a design does not grant exclusive production of this design to the customer.

If detailed information on potential tolerances is needed (e.g. cavity production for a metal parts), please contact Swarovski who will enter an application request into our application database.

# Crystal Rocks, Fine Rocks and Ultrafine Rocks

Synonym for luxury, this super dense crystallization option, uses only double pointed chatons in order to offer the most luxurious sparkle available in the market. Three different levels of refinement guarantee a perfect match to any style you desire with Crystal Rocks, Fine Rocks and Ultrafine Rocks.

The surface and edges of the Crystal Rocks family are smooth, which offers a whole new range of application possibilities. The Crystal Rocks family not only creates unique effects on accessories and jewelry, but also enhances textiles in an innovative way.

**Key features:**

- Modern look
- The ultimate crystallization, adding the most sparkle to any product
- Super luxurious – exclusively made with full-faceted crystals
- Adding a superior price premium to any product
- Express your creativity with the wide color assortment available
- Create the tiniest designs with Crystal Fine Rocks and Crystal Ultrafine Rocks XS
- Possibility to create Graphic prints
- Perfect color match with the Crystal Lacquered Foils

Crystal Rocks, Fine Rocks and Ultrafine Rocks

**ARTICLE EXPLANATION**

**Crystal Rocks**

**72 046**

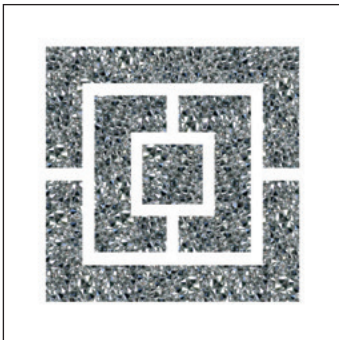

**C** 010-001CAL  
**S** ~63x64  
**M** 20 PCS **52%**

**Crystal Fine Rocks**

**74 101**

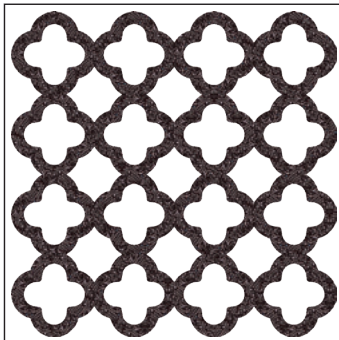

**C** 012-280  
**S** ~172x172  
**M** 2 PCS **25%**

**Crystal Ultrafine Rocks**

**89 962**



**C** 012-280  
**S** ~192x167  
**M** 2 PCS **20%**

<b>72 046</b>				<b>52%</b>
<b>74 101</b>				<b>25%</b>
<b>89 962</b>	<b>C</b>	<b>S</b>	<b>M</b>	<b>20%</b>

Article number	Color of crystals	Motif size in mm	Minimum order quantity in pieces (PCS)	% of actual size
----------------	-------------------	------------------	--	------------------

ORDERING EXAMPLE & PRODUCT VARIETY EXPLANATION

72 046		010	001 CAL
74 101		012	280
89 962	I	012	280

Article number	Type of base material	Color of base material	Color of crystals
	Hotfix	010 Transparent	Please see the respective product matrix for all available reference codes.
	C Coldfix	012 Black	
	I It version		
	R Removable foil		

AVAILABLE BASE MATERIALS AND CRYSTAL COLORS & EFFECTS

<p>72 000 74 000 89 900 onward</p>	<b>Color of Film</b>	010 Transparent (Hotfix; C_Coldfix; Removable Foil; _IT)	012 Black (Hotfix; C_Coldfix; _IT)	Burgundy (Hotfix; C_Coldfix; Removable Foil; _IT)	Laguna Emerald (Hotfix; C_Coldfix; Removable Foil; _IT)	Light Coral (Hotfix; C_Coldfix; Removable Foil; _IT)	Ocean Blue (Hotfix; C_Coldfix; Removable Foil; _IT)	Pink (Hotfix; C_Coldfix; Removable Foil; _IT)	Royal Red (Hotfix; C_Coldfix; Removable Foil; _IT)	Electric Yellow <sup>1</sup> (Hotfix; C_Coldfix*; Removable Foil*; _IT)	Electric Blue <sup>1</sup> (Hotfix; C_Coldfix*; Removable Foil*; _IT)	Electric Pink <sup>1</sup> (Hotfix; C_Coldfix*; Removable Foil*; _IT)	Electric Violet <sup>1</sup> (Hotfix; C_Coldfix*; Removable Foil*; _IT)	Electric Orange <sup>1</sup> (Hotfix; C_Coldfix*; Removable Foil*; _IT)	Electric White <sup>1</sup> (Hotfix; C_Coldfix*; Removable Foil*; _IT)		
	<b>Crystal</b>	Crystal (001)	■	■	■	■	■	■	■	■	■	■	■	■	■	■	
	<b>Color</b>																
	<b>Plain Color</b>																
	Erinite (360) <sup>1/2</sup>	■	■														
	Fuchsia (502) <sup>1/2</sup>	■	■														
	Jet (280)	■	■														
	Light Siam (227) <sup>2</sup>	■	■														
	Sunflower (292) <sup>1/2</sup>	■	■														
	Vintage Rose (319) <sup>2</sup>	■	■														
	<b>Opal Colors</b>																
	Rose Water Opal (395) <sup>1/2</sup>	■	■														
	White Opal (234) <sup>1/2</sup>	■	■														
	<b>Crystal Effects</b>																
	<b>Transparent Effects</b>																
Crystal Aurore Boreale (001 AB)	■	■	■	■	■	■	■	■	■	■	■	■	■	■	■	■	
Crystal Bermuda Blue (001 BBL)	■	■															
Crystal Golden Shadow (001 GSHA)	■	■															
Crystal Heliotrope (001 HEL) <sup>2</sup>	■	■															

<sup>1</sup> G4 color (MTO - special production)  
<sup>2</sup> not available for Crystal Ultrafine Rocks

Crystal Rocks, Fine Rocks and Ultrafine Rocks

<p>72 000 74 000 89 900 onward</p>		<b>Color of Film</b>		010 Transparent (Hoflix; C_Coldfix; Removable Foil; L_IT)	012 Black (Hoflix; C_Coldfix; L_IT)	Burgundy (Hoflix; C_Coldfix; Removable Foil; L_IT)	Laguna Emerald (Hoflix; C_Coldfix; Removable Foil; L_IT)	Light Coral (Hoflix; C_Coldfix; Removable Foil; L_IT)	Ocean Blue (Hoflix; C_Coldfix; Removable Foil; L_IT)	Pink (Hoflix; C_Coldfix; Removable Foil; L_IT)	Royal Red (Hoflix; C_Coldfix; Removable Foil; L_IT)	Electric Yellow <sup>1</sup> (Hoflix; C_Coldfix*; Removable Foil*; L_IT)	Electric Blue <sup>1</sup> (Hoflix; C_Coldfix*; Removable Foil*; L_IT)	Electric Pink <sup>1</sup> (Hoflix; C_Coldfix*; Removable Foil*; L_IT)	Electric Violet <sup>1</sup> (Hoflix; C_Coldfix*; Removable Foil*; L_IT)	Electric Orange <sup>1</sup> (Hoflix; C_Coldfix*; Removable Foil*; L_IT)	Electric White <sup>1</sup> (Hoflix; C_Coldfix*; Removable Foil*; L_IT)
Crystal Metallic Light Gold (001 MLGLD) <sup>1</sup>																	
Crystal Metallic Sunshine (001 METSH)*																	
Crystal Moonlight (001 MOL)																	
Crystal Paradise Shine (001 PARSH)																	
Crystal Shimmer (001 971) <sup>1</sup>																	
Crystal Silver Shade (001 SSHA)																	
<b>Metallic Effects</b>																	
Crystal Chrome (001 CHRM)																	
Crystal Comet Argent Light (001 CAL)																	
Crystal Metallic Silver (001 METSI) <sup>1</sup>																	
<b>Color Effects</b>																	
<b>Transparent Effects</b>																	
Light Siam Shimmer (227 971) <sup>1</sup>																	
<b>Multicolors</b>																	
Jet & Crystal Metallic Silver (001 M100) <sup>2</sup>																	
Jet & Crystal Comet Argent Light (001 M106) <sup>1/2</sup>																	
Crystal & Crystal Moonlight (001 M126)																	

The Crystal Lacquered Foils combine the crystal shine of our Crystal Textures with customizable lacquer colors, opening up a new world of endless color possibilities. Transforming any chosen Pantone color in a new sparkling color variant for our Crystal Fabric and our Crystal Rocks family, they provide the best solution when looking for the perfect color match. They are ideal for monochromatic motifs with lower tolerances, improved color quality and maximum customization flexibility.

Standard colors are ready for reference. Customization possibilities are available through an inquiry to our Special motif service or through our Customer Service.

Please be aware that this unique technology cannot be combined with XS, Unlimited or Foil Overlay.

\* Crystal Metallic Sunshine (001 METSH) is not suitable for swimwear because effect 001 METSH is highly sensitive to seawater, sweat, and chlorine.  
<sup>1</sup> G4 color (MTO - special production)  
<sup>2</sup> not available for Crystal Ultrafine Rocks  
 Please note: Crystal Comet Argent Light (001 CAL) is not suitable for swimwear because effect 001 CAL is highly sensitive to seawater, sweat, and chlorine.



OVERVIEW OF AVAILABLE COLORS & EFFECTS FOR THE CRYSTAL ROCKS FAMILY\*

Crystal (001)



010 Transparent

Erinite (360)<sup>1/2</sup>

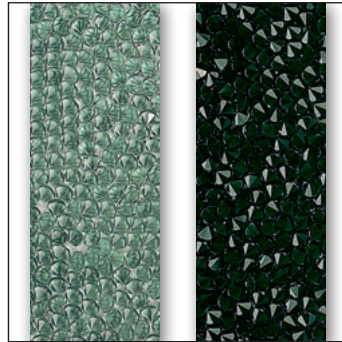

010 Transparent

012 Black

Fuchsia (502)<sup>1/2</sup>



012 Black

Jet (280)



012 Black

Light Siam (227)<sup>2</sup>

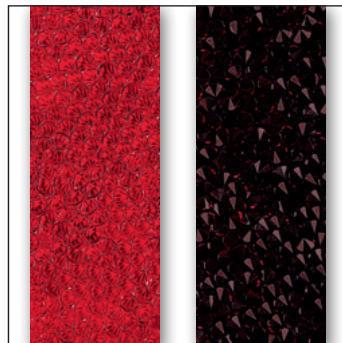

010 Transparent

012 Black

Sunflower (292)<sup>1/2</sup>



010 Transparent

012 Black

Vintage Rose (319)<sup>1/2</sup>



010 Transparent

012 Black

Rose Water Opal (395)<sup>1/2</sup>

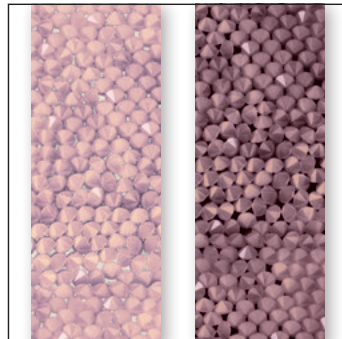

010 Transparent

012 Black

White Opal (234)<sup>1/2</sup>

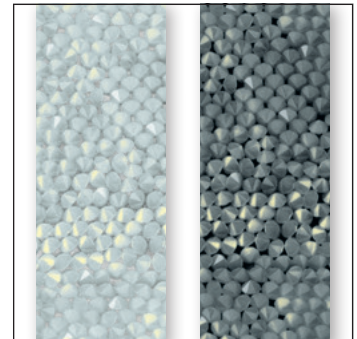

010 Transparent

012 Black

\* Color illustrations in Crystal Rocks representative of all Crystal Rocks variants

<sup>1</sup> G4 color (MTO - special production)

<sup>2</sup> not available for Crystal Ultrafine Rocks

Crystal Aurore Boreale (001 AB)

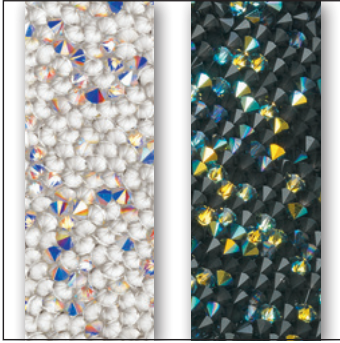

010 Transparent 012 Black

Crystal Bermuda Blue (001 BBL)



012 Black

Crystal Golden Shadow (001 GSHA)



010 Transparent

Crystal Heliotrope (001 HEL)<sup>2</sup>



012 Black

Crystal Metallic Light Gold (001 MGLD)<sup>1</sup>

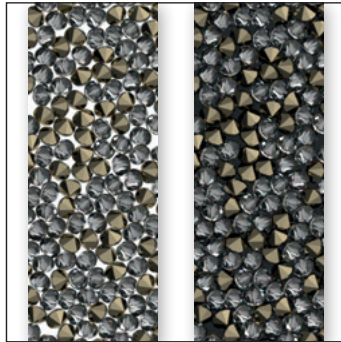

010 Transparent 012 Black

Crystal Metallic Sunshine (001 METSH)

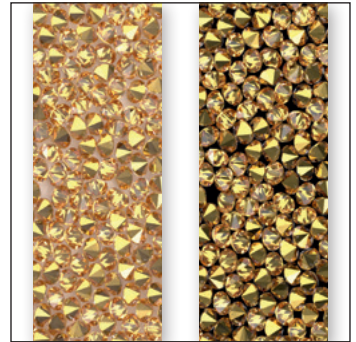

010 Transparent 012 Black

Crystal Moonlight (001 MOI)

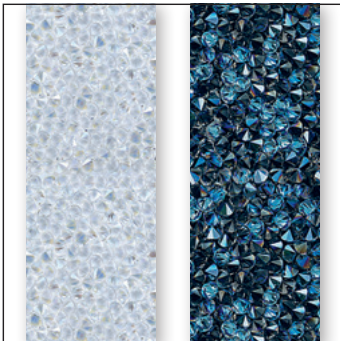

010 Transparent 012 Black

Crystal Paradise Shine (001 PARSH)

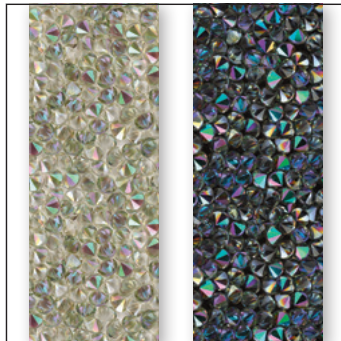

010 Transparent 012 Black

Crystal Shimmer (001 971)<sup>1</sup>

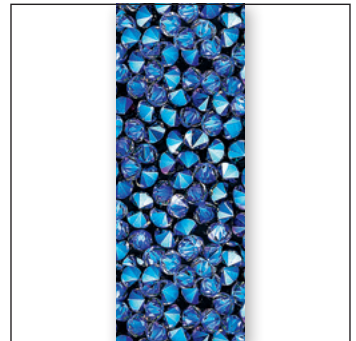

012 Black

<sup>1</sup> G4 color (MTO - special production)

<sup>2</sup> not available for Crystal Ultrafine Rocks

Crystal Silver Shade (001 SSHA)



010 Transparent 012 Black

Crystal Chrom (001 CHRM)

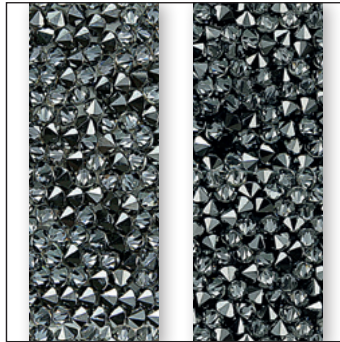

010 Transparent 012 Black

Crystal Comet Argent Light (001 CAL)

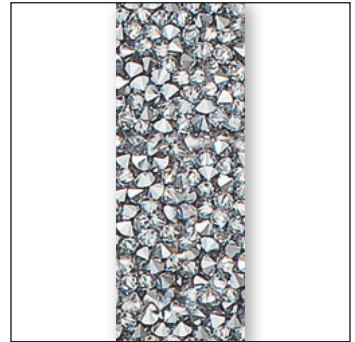

010 Transparent

Crystal Metallic Silver (001 METSI)<sup>1</sup>

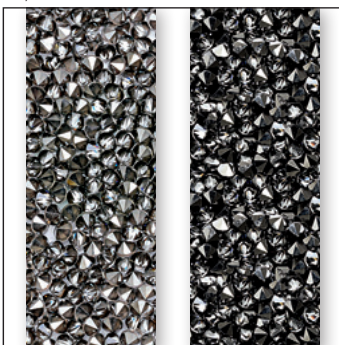

010 Transparent 012 Black

Light Siam Shimmer (227 971)<sup>1</sup>

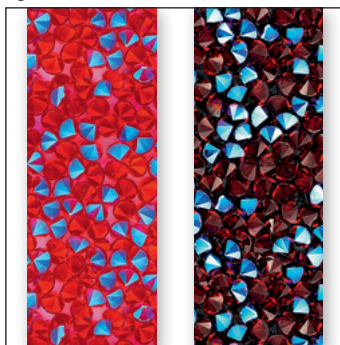

010 Transparent 012 Black

Jet & Crystal Metallic Silver (001 M100)<sup>2</sup>



012 Black

Jet & Crystal Comet Argent Light  
(001 M106)<sup>1/2</sup>

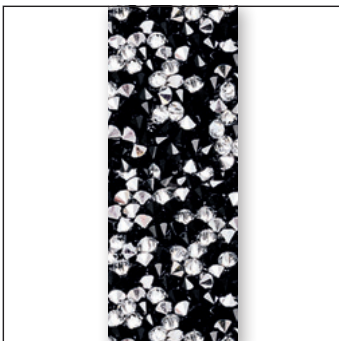

012 Black

Crystal & Crystal Moonlight  
(001 M126)

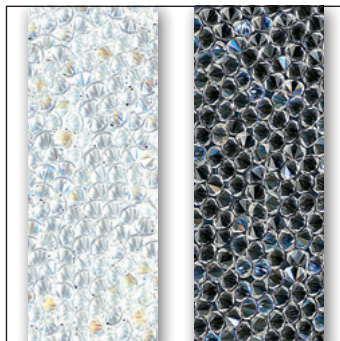

010 Transparent 012 Black

<sup>1</sup> G4 color (MTO - special production)  
<sup>2</sup> not available for Crystal Ultrafine Rocks

**Lacquered Foils colors**

Burgundy Foil  
622F53

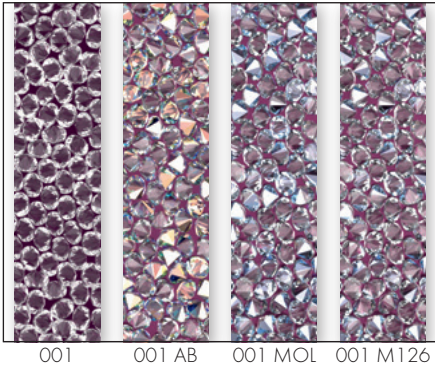

Laguna Emerald Foil  
00958A

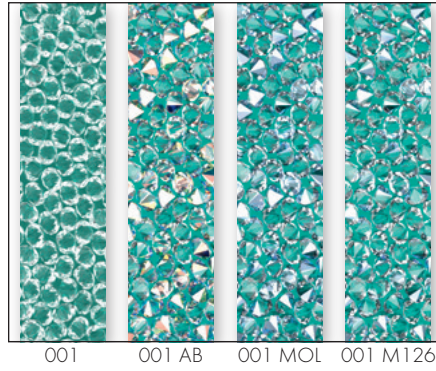

Light Coral Foil  
F6624C

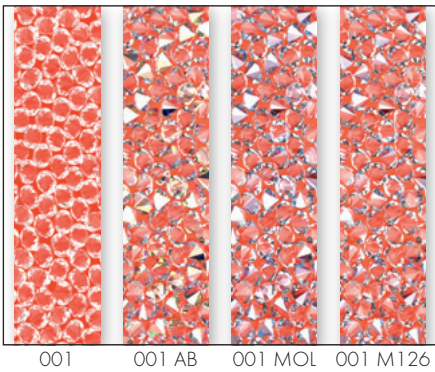

Ocean Blue Foil  
4D7CBC

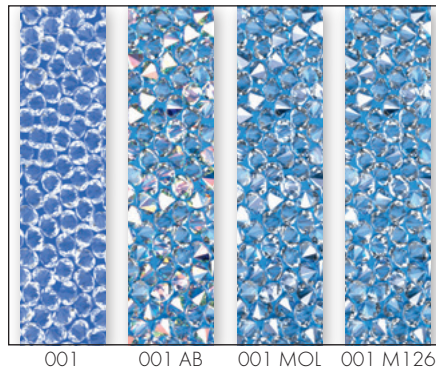

Pink Foil  
ECB3CB

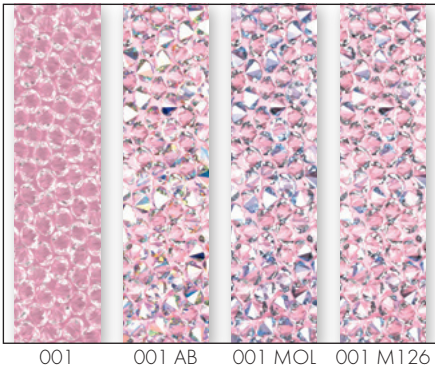

Royal Red Foil  
B81B36

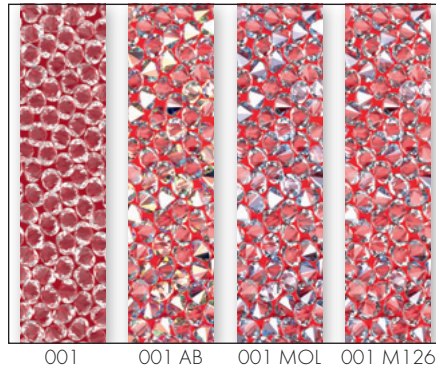

Crystal Rocks, Fine Rocks and Ultrafine Rocks

Lacquered Foils with Electric Lacquer<sup>PRO</sup> Effects

Electric Yellow (001 L138S)  
FFFF00

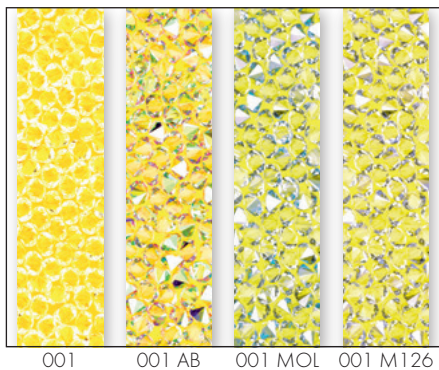

Electric Blue (001 L134S)  
0097D6

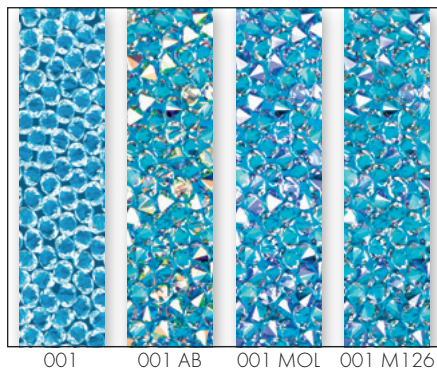

Electric Pink (001 L137S)  
FF4FB1

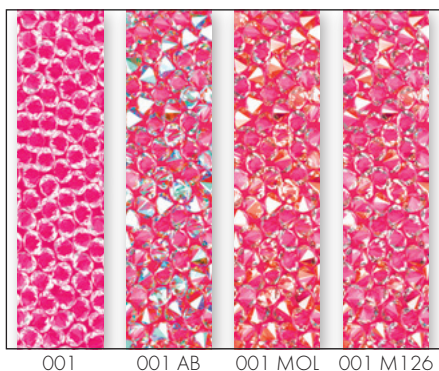

Electric Violet (001 L148S)  
AB61C0

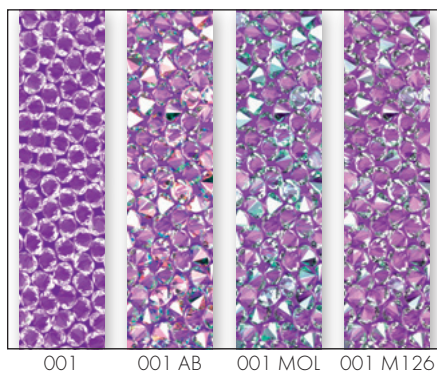

Electric Orange (001 L136S)  
FF5557

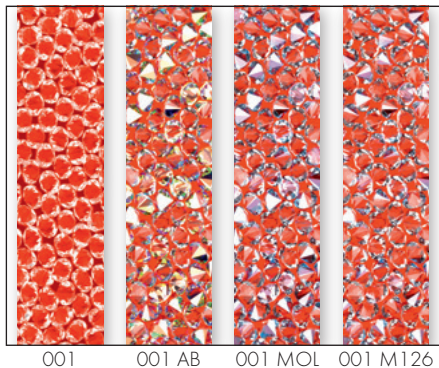

Electric White (001 L139S)  
D8DEE9

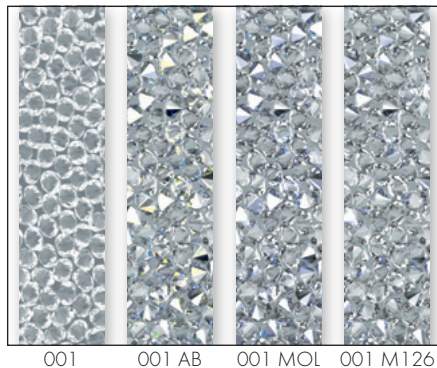

INSPIRATIONAL MOTIFS

Crystal Rocks

72 046

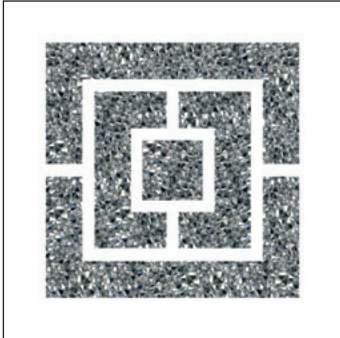

C 010-001CAL  
S ~63x64  
M 20 PCS 52%

72 001



C 012-280  
S ~80x80  
M 12 PCS 45%

72 003

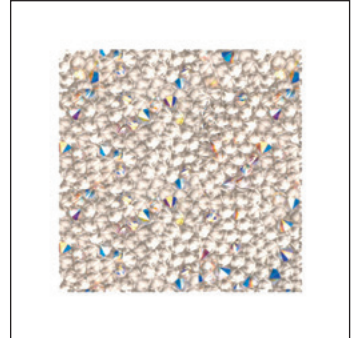

C 010-001 AB  
S ~40x40  
M 48 PCS 80%

72 038

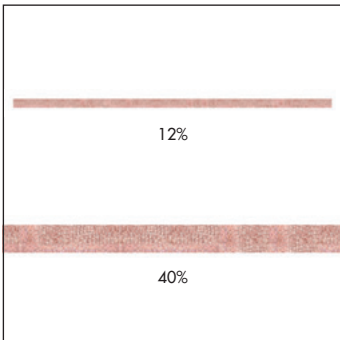

C 010-319  
S ~345x9  
M 18 PCS

72 055

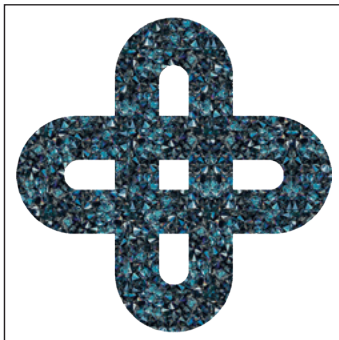

C 012-001MOL  
S ~64x64  
M 30 PCS 65%

72 058

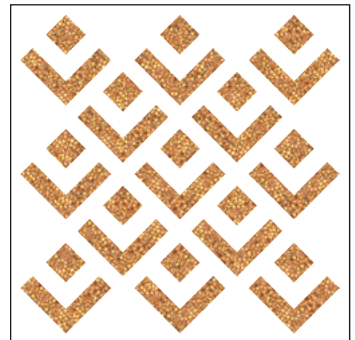

C 010-001METSH  
S ~168x168  
M 2 PCS 25%

72 060

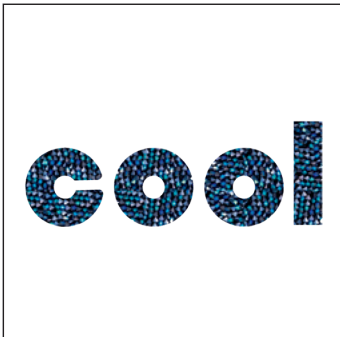

C I012-001BBL  
S ~98x35  
M 27 PCS 40%

72 066

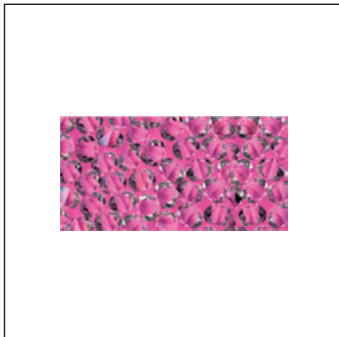

C HFF4FB1 001M126  
S ~30x15  
M 140 PCS 100%

72 067



C 010-001 GSHA  
S ~374x254  
M 01 PCS 11%

Please note: all motifs are available in certain color/film variations (see color matrix).

Crystal Fine Rocks

74 101

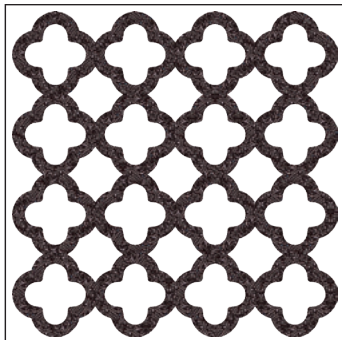

C 012-280  
S ~172x172  
M 2 PCS 25%

74 003



C 010-001GSHA  
S ~24x24  
M 120 PCS 100%

74 019

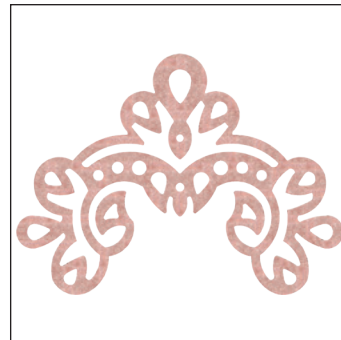

C 010-319  
S ~154x113  
M 8 PCS 28%

74 048

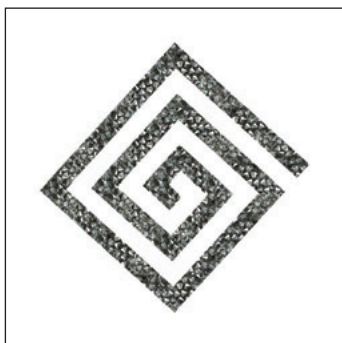

C 010-001CHRM  
S ~59x59  
M 48 PCS 60%

74 050

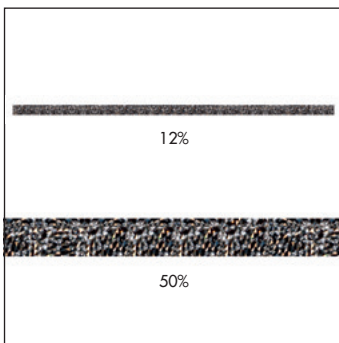

C 010-001METS  
S ~345x10  
M 17 PCS

74 054

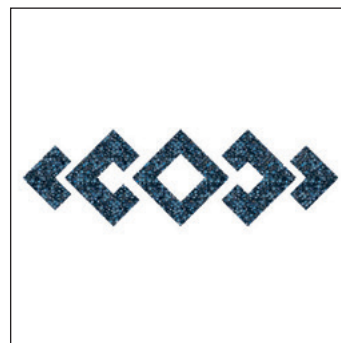

C 012-001MOL  
S ~139x42  
M 14 PCS 30%

74 102

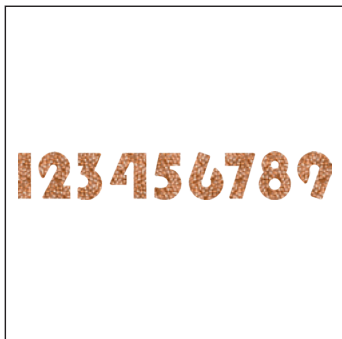

C 010-001GSHA  
S ~138x21  
M 26 PCS 30%

74 103

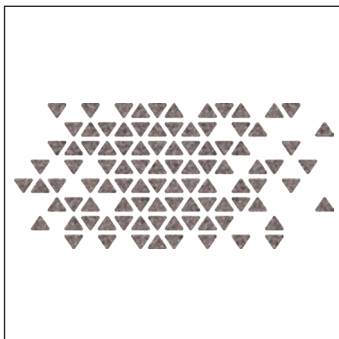

C 010-001METS  
S ~248x113  
M 3 PCS 17%

74 112



C 012-001MOL  
S ~35x49  
M 56 PCS 80%

10

Please note: all motifs are available in certain color/film variations (see color matrix).

**Crystal Ultrafine Rocks**

**89 962**



**C** 012-280  
**S** ~192x167  
**M** 2 PCS **20%**

**89 906**

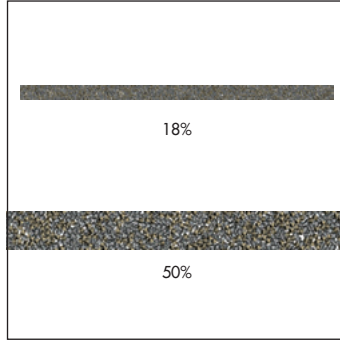

**C** 010-001MLGD  
**S** ~230x10  
**M** 17 PCS

**89 908**



**C** 010-001CAL  
**S** ~39x38  
**M** 68 PCS **100%**

**89 911**

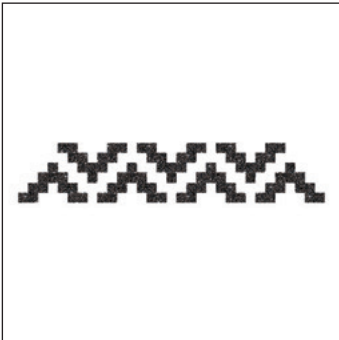

**C** 012-001METSJ  
**S** ~135x26  
**M** 27 PCS **30%**

**89 919**

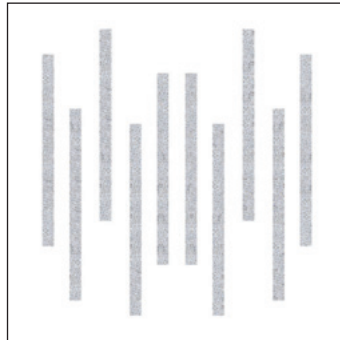

**C** 010-001MOL  
**S** ~79x84  
**M** 12 PCS **45%**

**89 959**

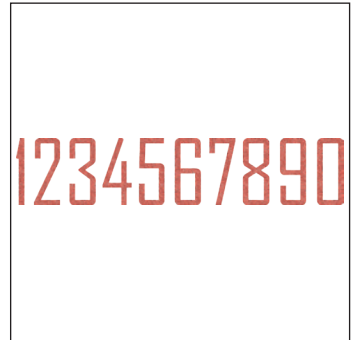

**C** H-F6624C-001  
**S** ~241x49  
**M** 7 PCS **18%**

**89 960**

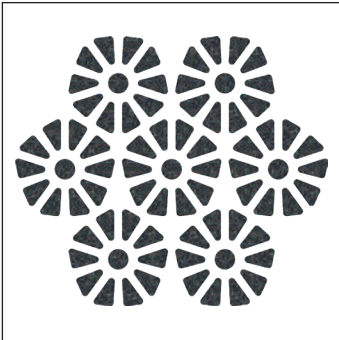

**C** 012-001PARSH  
**S** ~138x118  
**M** 6 PCS **30%**

**89 961**



**C** H-ECB3CB-001  
**S** ~77x50  
**M** 20 PCS **55%**

**89 965**



**C** H-FF5557-001  
**S** ~128x32  
**M** 20 PCS **33%**

Please note: all motifs are available in certain color/film variations (see color matrix).



## SPECIAL MOTIF SERVICE

A special motif is a design created by the customer that differs to the Crystal Rocks-Family Inspirational Collection.. This service opens up an abundance of customization possibilities and enables you to profit from Swarovski's long-standing experience and design expertise. A range of customization options for existing motifs is available (see "Customization Possibilities"

below). You can also submit design sketches that meet your special needs, such as a brand image or an image to suit a particular sales campaign. This will then be made up according to your specifications using Computer Aided Design, which means that adjustments can be made easily according to your needs.

### Customization Possibilities the respective product groups

	CRYSTAL ROCKS	CRYSTAL FINE ROCKS	CRYSTAL ULTRAFINE ROCKS
Max. motif size	400x330 mm	400x330 mm	400x330 mm
Min. motif size	15x15 mm or effective surface of 2.25 cm <sup>2</sup>	15x15 mm or effective surface of 2.25cm <sup>2</sup>	15x15 mm or effective surface of 2.25cm <sup>2</sup>
Min. width of gaps within motifs	3 mm	3 mm	3 mm
Min. product surface	9 mm	4 mm <sup>1</sup>	3.4 mm
Min. size of the smallest element within a motif	15x15 mm or effective area of 2.25 cm <sup>2</sup>	15x15 mm or effective surface of 2.25 cm <sup>2</sup>	15x15 mm or effective surface of 2.25 cm <sup>2</sup>
Edges & angles less than $\neq < 90^\circ$ need to be rounded off (diameter]	3 mm (diameter $\varnothing$ 1.5 mm)	2.7 mm (diameter $\varnothing$ 1.35 mm)	2 mm (diameter $\varnothing$ 1 mm)

10

### Ordering Process

Send your request with the drawing you wish to order to your nearest Swarovski sales office. Make sure you include all measurements for the desired motif. Please also indicate which product group your special motif applies to (Crystal Rocks). You will then receive a quotation including

your article number, minimum order quantity, price, and the line drawing of your special motif in PDF format. Please contact your Swarovski sales office again if any changes need to be made. Your special motif will be produced and delivered following your confirmation.

### Please Note

Please always submit the drawing of your desired motif to represent it in the actual size you require. A small sketch, when enlarged to the desired size, will have blurred lines that will make it difficult to correctly reproduce. Pictures or drawings representing 100% size of the design or very good quality scans in JPG, BMP, or DXF format will ensure that we have clear data to work with. These can also be sent via email. If sending a sewing pattern, please include the whole pattern and not just sections. When the sketch is submitted as a copy by email, please include a scale legend (e.g. copy/scan with a ruler next to the drawing). This will ensure that the desired size of the motif can be identified.

It is generally possible to draw motifs with a minimum gap of 10 mm between the outlines. However, due to the tolerance level of the crystals being applied onto carrier film, the final Crystal Rocks motifs may differ from sketches

or prints in relation to the motifs' outline, especially with regards to spaces that are smaller than 10 mm. Therefore the motif, and by extension, the product itself, may be subject to individual variations with each reproduction. These variations are caused by technical production-related factors. As these variations are not deemed to be defects, warranty claims are excluded and Swarovski assumes no liability whatsoever in connection with them.

Special productions are generally offered to all our customers if these are deemed to be feasible and comply with our General Terms and Conditions. Please note ordering of a design does not grant exclusive production of this design to the customer.

If detailed information on the possible tolerances is required (e.g. cavity production for metal parts), please contact your local Swarovski sales office who will enter an application request into our application database.

<sup>1</sup> Bandings (strips over 100mm in length) in 5mm widths cannot be produced.

# Graphic - The Limitless Crystal Printing Technology

## GRAPHIC FABRIC, ROCKS, FINE ROCKS, ULTRAFINE ROCKS, FINE ROCKS XS & ULTRAFINE ROCKS XS

Taking the word “image” from “imagination” and leading it to new creative heights, Swarovski presents a new graphic technology that opens up a world of design possibilities – in an unprecedented richness of detail!

The Graphic products allow for the printing of individual motifs – such as pictures, graphics, logos, or lettering – onto customer favorites Crystal Fabric, Crystal Rocks, Crystal Fine Rocks, and Crystal Ultrafine Rocks.

The three different printing methods (Foil Print )FP), Glass Print (GP) and combination of Foil & Glass Print (FP&GP), enrich your personal motif with a sparkling 3D surface for stunning effects in a series of application fields.

As a true highlight and stunning innovation in our assortment, the Graphic Fabric, Ultrafine Rocks, Fine Rocks, and Rocks speak to the rising demand for personalized design items, emphasizing our desire for an individual look in a world of mass production.

## GRAPHIC OFFERS THREE BRILLIANT PRINTING TECHNIQUES FOR LIMITLESS CREATIVE POWER:



### Foil Print (FP)

Printed directly on the foil, underneath the crystals.

Foil Print allows for optimal brilliance. It is recommended for simple motifs and prints where blurred contours are a design element.



### Glass Print (GP)

Printed directly onto the crystals, on the surface.

Glass Print ensures an incredibly precise reproduction of the desired motif, with a soft, matte effect.

It is recommended for complex motifs and prints.



### Combination of Foil & Glass Print (FP&GP)

Printed onto both foil and crystals.

This unique printing technique ensures complete customization and design innovation, with stunning depth of detail.

When overlapped, prints merge to create an illusion of vibrant 3D texture.

Please note: Due to their physical properties, Swarovski's self adhesive products are unsuitable for other uses such as gluing onto teeth, using on or near mucous membranes, and other unsafe uses.

ARTICLE EXPLANATION

Graphic Fabric

57 430



C 022-FP24791 001M500  
 S ~332x72  
 M 9 PCS 13%

Graphic Rocks

72 061

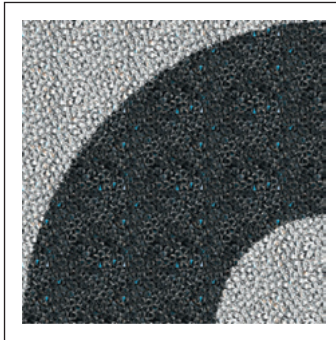

C 022-FP24786 001M126  
 S ~100x100  
 M 9 PCS 40%

Graphic Fine Rocks

74 104

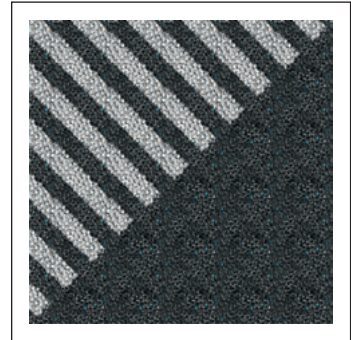

C 022-FP24787 001M126  
 S ~100x100  
 M 9 PCS 40%

Graphic Fine Rocks XS

74 097



C 022-FP21291 001M126 XS  
 S ~79x95  
 M 12 PCS 45%

Graphic Ultrafine Rocks

89 957



C 022-FP24793 001M126  
 S ~235x177  
 M 2 PCS 18%

Graphic Ultrafine Rocks XS

89 951



C 022-FP21292 001M126 XS  
 S ~19x64  
 M 60 PCS 63%

10

57 382  
 72 061  
 74 104  
 74 097  
 89 957  
 89 951

C

S

M

Article number

Color assortment

Motif size in mm

Minimum order quantity in pieces (PCS)

FP Foil print  
 GP Glass print

**ORDERING EXAMPLE & PRODUCT VARIETY EXPLANATION**

<b>57 382</b>	<b>FP12771 GP12770</b>	<b>022</b>		<b>001AB</b>	<b>XS</b>
Article number	Print technique	Type of base material	Color of film	Color of crystals	Extra Small
	FP Foil Print		Hotfix	Please see the respective product matrix for all available reference codes.	
	GP Glass Print	022 White	C Coldfix		
	FP & GP Foil Print & Glass Print	012 Black 010 Transparent	I It version R Removable foil		

OVERVIEW OF ALL AVAILABLE COLORS AND EFFECTS

Graphic Fabric









57 000 onward	Color of film	010 Transparent	012 Black	022 White	Print	Print on Foil <sup>1</sup>	Print on Glass
<b>Crystal Effects</b>							
<b>Transparent Effects</b>							
Crystal Aurore Boreale (001 AB)		■		■		■	■
Crystal Golden Shadow (001 GSHA)		■		■		■	■
<b>Metallic Effects</b>							
Crystal Comet Argent Light (001 CAL)		■					■
<b>Crystal Effects</b>							
<b>Transparent Effects</b>							
Jet Hematite (280 HEM)			■				■
<b>Multicolors</b>							
Crystal & Crystal Moonlight (001 M500)		■	■	■		■	■

<sup>1</sup> Print on Foil will not be visible on covering colors/effects and therefore this variation will not be offered in combination with covering colors/effects. Only if "Print on Foil" is possible will a combination of both (Print on Foil & Print on Glass) be offered.

## OVERVIEW OF ALL AVAILABLE COLORS AND EFFECTS

### Graphic Rocks, Fine Rocks, Fine Rocks XS, Ultrafine Rocks and Ultrafine Rocks XS

Graphic - The Limitless Crystal Printing Technology Inspirational Motifs

72 000, 74 000 & 89 900 onward		Color of film					
		010 Transparent	012 Black	022 White	Print	Print on Foil <sup>1</sup>	Print on Glass
<b>Colors</b>							
<b>Plain Colors</b>							
 Crystal (001)		■		■		■	■
 Jet (280)			■				■
<b>Crystal Effects</b>							
<b>Transparent Effects</b>							
 Crystal Aurore Boreale (001 AB)		■		■		■	■
 Crystal Golden Shadow (001 GSHA)		■		■		■	■
 Crystal Moonlight (001 MOL)		■		■		■	■
 Crystal Silver Shade (001 SSHA)		■		■		■	■
<b>Metallic Effects</b>							
 Crystal Comet Argent Light (001 CAL)		■					■
<b>Multicolors</b>							
 Crystal & Crystal Moonlight (001 M126)		■	■	■		■	■

<sup>1</sup> Print on Foil will not be visible on covering colors/effects and therefore this variation will not be offered in combination with covering colors/effects. Only if "Print on Foil" is possible will a combination of both (Print on Foil & Print on Glass) be offered.

INSPIRATIONAL MOTIFS

Graphic Fabric – 57 000 onward

57 430



C 022-FP24791 001M500  
 S ~332x72  
 M 9 PCS 13%

57 435



C 022-FP27191 GP27192 001M500  
 S ~104x127  
 M 16 PCS 33%

57 435

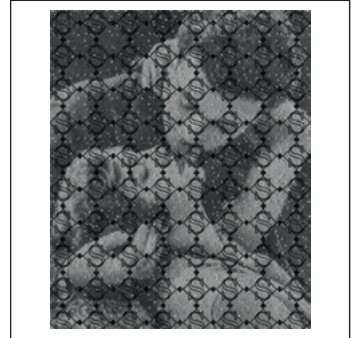

C 022-FP27193 GP27194 001M500  
 S ~104x127  
 M 16 PCS 33%

57 435



C 022-FP27196 GP27197 001M500  
 S ~104x127  
 M 16 PCS 33%

57 435

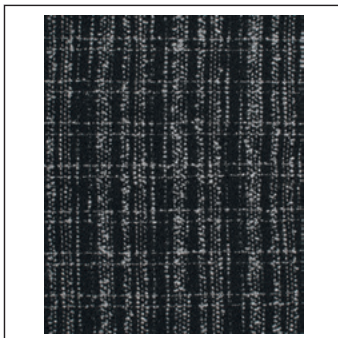

C 010-GP27199 001CAL  
 S ~104x127  
 M 16 PCS 33%

57 435

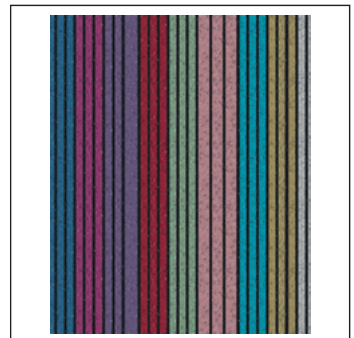

C 010-GP27200 001CAL  
 S ~104x127  
 M 16 PCS 33%

57 435

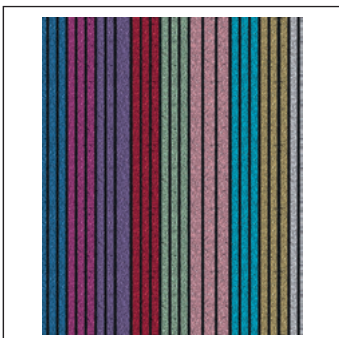

C 022-GP27200 001M500  
 S ~104x127  
 M 16 PCS 33%

57 435

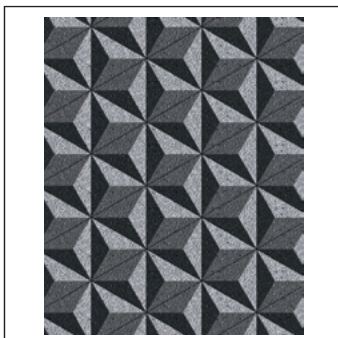

C 010-GP27198 001CAL  
 S ~104x127  
 M 16 PCS 33%

57 435



C 022-FP27195 001M500  
 S ~104x127  
 M 16 PCS 33%

Graphic Rocks – 72 000 onward

72 061

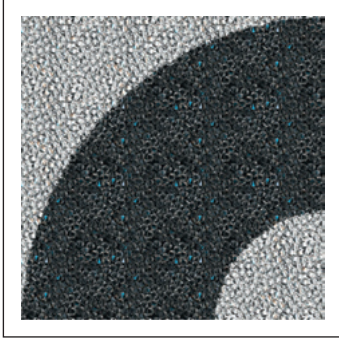

<b>C</b>	022-FP24786 001M126
<b>S</b>	~100x100
<b>M</b>	9 PCS <b>40%</b>

72 061



<b>C</b>	022-FP 24782 001M126
<b>S</b>	~100x100
<b>M</b>	9 PCS <b>40%</b>

72 063



<b>C</b>	022-GP24833 001M126
<b>S</b>	~80x82
<b>M</b>	12 PCS <b>50%</b>



Graphic Fine Rocks – 74 000 onward

74 104

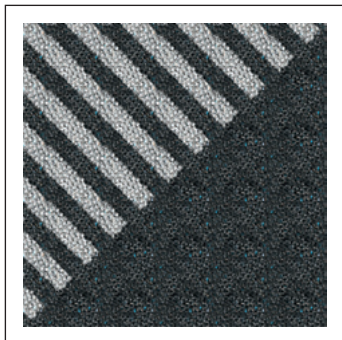

**C** 022-FP24787 001M126  
**S** ~100x100  
**M** 9 PCS **40%**

74 108

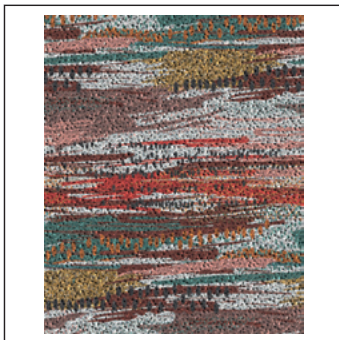

**C** 010-GP27181 001CAL  
**S** ~104x127  
**M** 9 PCS **33%**

74 108



**C** 012-WP27180 280  
**S** ~104x127  
**M** 9 PCS **33%**

74 108



**C** 022-FP27182 GP27183OP  
 001M126  
**S** ~104x127  
**M** 9 PCS **33%**

Graphic Fine Rocks XS – 74 000 onward

74 096



<b>C</b>	022-FP21290 001M126 XS	
<b>S</b>	~24x80	
<b>M</b>	40 PCS	<b>50%</b>

74 097



<b>C</b>	022-FP21291 001M126 XS	
<b>S</b>	~79x95	
<b>M</b>	12 PCS	<b>45%</b>

Graphic Ultrafine Rocks – 89 900 onward

89 957



C 022-FP24793 001M126  
 S ~235x177  
 M 2 PCS 18%

89 964



C 022-FP24784 001M126  
 S ~100x100  
 M 9 PCS 40%

Graphic Ultrafine Rocks XS

89 951



C 022-FP21292 001M126 XS  
 S ~19x64  
 M 60 PCS 65%

89 952



C 022-FP21293 001M126 XS  
 S ~63x81  
 M 16 PCS 50%

### GRAPHIC METALLIC COLORS

Combining our existing Graphic products (Crystal Fabric, Crystal Ultrafine Rocks, Crystal Fine Rocks, Crystal Rocks) in Comet Argent Light (001 CAL) with a special selected color tone to imitate any metallic look.

The Crystal Textures New Metallic Colors in Fabric, Rocks, Fine Rocks and Ultrafine Rocks (Hotfix and Coldfix) present an array of unprecedented vibrant styling options for apparel and accessories. With countless luxurious creative possibilities, these modern metallic hues turn simple designs into precious high-voltage pieces with a retro edge or even a revived 80s vibe. Perfectly suited for up-trending fashion and accessory styles, their energy and brilliance are unparalleled.

Metallic Colors are only possible with the effect Comet Argent Light (001 CAL) on transparent film color (010). Customer service will forward your request with the "Graphic inquiry form". Please make sure that all information is included in this form. The image data and also the system number will be created from the special design team.

Please be aware of the general product and color tolerances. Detailed information could be found in the "general product information".

### ARTICLE EXPLANATION

#### Graphic Fabric

57 401

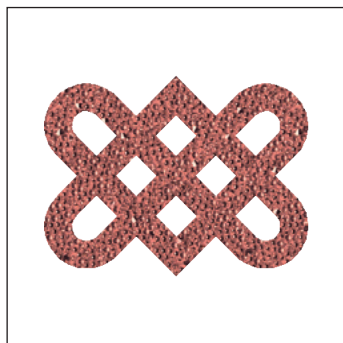

<b>C</b>	010-GP27430ROGL001CAL
<b>S</b>	~28x21
<b>M</b>	250 PCS <b>100%</b>

Graphic - Metallic Colors

57 401	C	S	M
Article number	Color assortment GP Glass print	Motif size in mm	Minimum order quantity in pieces (PCS)

### Ordering Example & Product Variety Explanation

57 401	GP27430	ROGL	010	001 CAL
Article number	Print technique GP Glass Print	Graphic Color GOLD ROGL (Rose Gold) Metallic Multicolor	Color of film Hotfix version: 010 Transparent It version: I010 Transparent Coldfix version: C010 Transparent Removable foil: R10	Color of crystals For all metallics only 001 CAL as a base is possible

OVERVIEW OF ALL AVAILABLE COLORS AND EFFECTS

Graphic

57 000  
onward

Color of Film & Crystal  
010 001 CAL

Metallic Colors\*

GOLD

ROGL

Customized Metallic Colors\*\*

FabricGraphic Rocks, Fine Rocks, Ultrafine Rocks

72 000  
74 000  
89 900  
onward

Color of Film & Crystal  
010 001 CAL

Metallic Colors\*

GOLD

ROGL

Customized Metallic Colors\*\*

Fine Rocks XS, Ultrafine Rocks XS

74 000  
89 900  
onward

Color of Film & Crystal  
010 001 CAL

Metallic Colors\*

Customized Metallic Colors\*\*

\* Metallic colors are created combining our glass printing (GP) technology with Comet Argent Light crystals (CAL 001). This innovative technique allows any printed motif to be transformed into an extra-luxurious and precious piece.

This technique is available for any color tone on Crystal Fabric, Crystal Rocks, Crystal Fine Rocks, Crystal Ultrafine Rocks, and for XS motifs.

\*\* Customer can chose their desired metallic color tone, any chosen style can be transformed into a vibrant metallic color. Please provide our special motif service the respective RGB or CMYK color tone to be transformed into a metallic color.

INSPIRATIONAL MOTIFS

Graphic Fabric

57 401

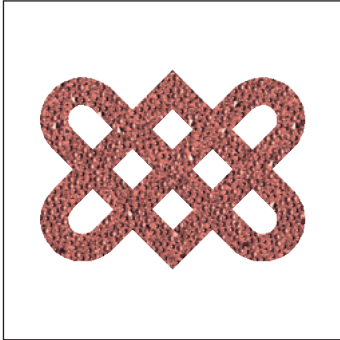

**C** 010-GP27430ROGL001CAL  
**S** ~28x21  
**M** 250 PCS **100%**

57 390



**C** 010-GP23843 001CAL  
**S** ~41x40  
**M** 56 PCS **80%**

57 435

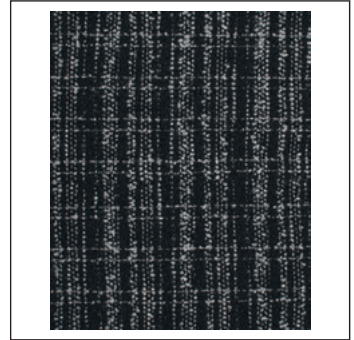

**C** 010-GP27199 001CAL  
**S** ~104x127  
**M** 16 PCS **33%**

Graphic - Metallic Colors Inspirational Motifs

57 435



**C** 010-GP27200 001CAL  
**S** ~104x127  
**M** 16 PCS **33%**

57 435

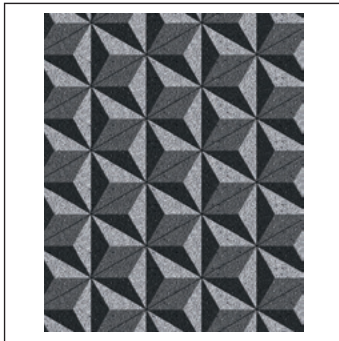

**C** 010-GP27198 001CAL  
**S** ~104x127  
**M** 16 PCS **33%**

Please note: Crystal Comet Argent Light (001 CAL) is not suitable for swimwear because effect 001 CAL is highly sensitive to seawater, sweat, and chlorine.

Graphic Fine Rocks

74 072

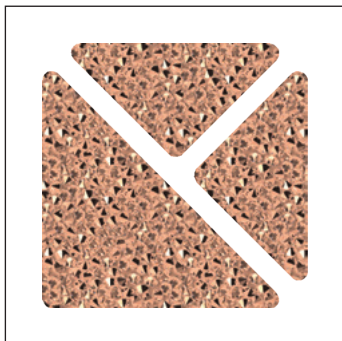

<b>C</b>	010-GP27431 GOLD 001 CAL
<b>S</b>	~40x40
<b>M</b>	42 PCS <span style="float: right;"><b>70%</b></span>

74 108

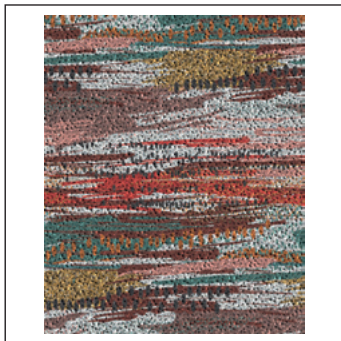

<b>C</b>	010-GP27181 001 CAL
<b>S</b>	~104x127
<b>M</b>	9 PCS <span style="float: right;"><b>33%</b></span>

Please note: Crystal Comet Argent Light (001 CAL) is not suitable for swimwear because effect 001 CAL is highly sensitive to seawater, sweat, and chlorine.

**Graphic Fine Rocks XS**

**74 099**

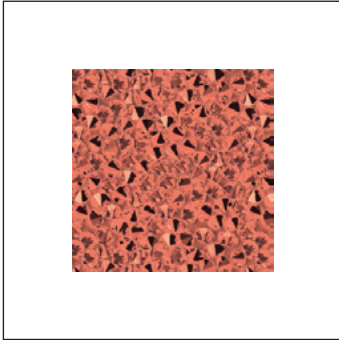

**C** 010-GP23845 001CAL  
**S** ~21x21  
**M** 143 PCS **100%**

**74 099**

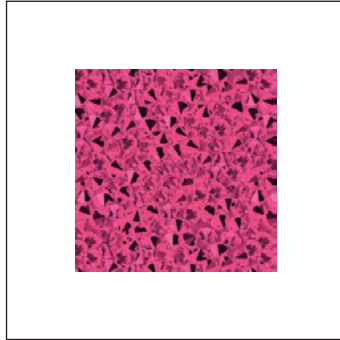

**C** 010-GP23846 001CAL  
**S** ~21x21  
**M** 143 PCS **100%**

**74 099**

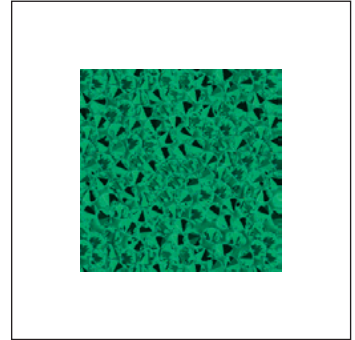

**C** 010-GP23847 001CAL  
**S** ~21x21  
**M** 143 PCS **100%**

**74 099**

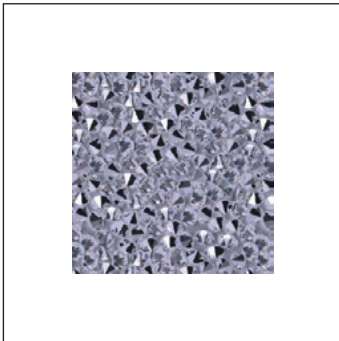

**C** 010-GP23848 001CAL  
**S** ~21x21  
**M** 143 PCS **100%**

**74 099**

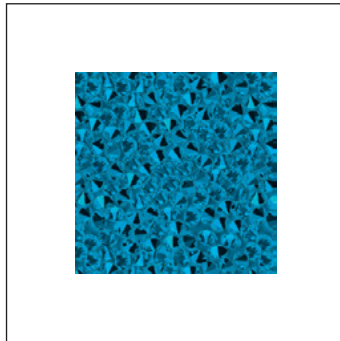

**C** 010-GP23849 001CAL  
**S** ~21x21  
**M** 143 PCS **100%**

**74 099**

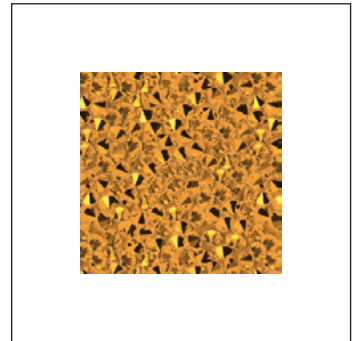

**C** 010-GP23850 001CAL  
**S** ~21x21  
**M** 143 PCS **100%**

Graphic - Metallic Colors Inspirational Motifs

Please note: Crystal Comet Argent Light (001 CAL) is not suitable for swimwear because effect 001 CAL is highly sensitive to seawater, sweat, and chlorine.



Graphic Ultrafine Rocks XS

89 949



<b>C</b>	010-GP23851 010 001CAL XS
<b>S</b>	~58x58
<b>M</b>	42 PCS <span style="float: right;">55%</span>

89 958

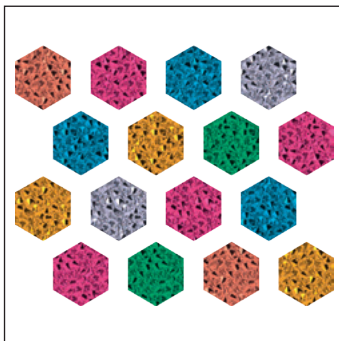

<b>C</b>	010-001CAL
<b>S</b>	~49x40
<b>M</b>	42 PCS <span style="float: right;">85%</span>

Please note: Crystal Comet Argent Light (001 CAL) is not suitable for swimwear because effect 001 CAL is highly sensitive to seawater, sweat, and chlorine.

# Information on Graphic

## SPECIAL MOTIF SERVICE

A special motif is a design created by the customer that differs to the Graphic Fabric, Ultrafine Rocks, Fine Rocks & Rocks Inspirational Collection. This service opens up an abundance of customization possibilities and enables you to benefit from Swarovski's long-standing experience and design expertise. A range of customization options for existing motifs is available (see "Customization Possibilities" below).

You can also submit design sketches that meet your personal requirements, such as a brand image or an image for a particular sales campaign. This will then be made up according to your specifications using Computer Aided Design, which means that adjustments can be made easily according to your needs.

### Required information for Graphic Fabric, Ultrafine Rocks, Fine Rocks & Rocks and XS

<b>data format contour/outline</b>	vector graphics (.dxf, .ai, .eps, .dwg)
<b>data format picture</b>	raster image format (.tiff, .pdf, .psd, .png) / vector format (.ai, .eps, .pdf)
<b>picture resolution &amp; size</b>	min. 300dpi (real size)
<b>colors</b>	RGB or CMYK
<b>fonts</b>	convert text to paths/outlines

Due to the different print methods (print on foil or glass), the colors may vary. Please be aware that possible color variations are more visible on single-color motifs than on images with many different colors. If you require

information and possible print tolerances (offset, color tolerance, etc.) please contact Swarovski and an application request will be entered into our application database.

### Customization Possibilities the respective product groups

	GRAPHIC FABRIC	GRAPHIC ULTRAFINE ROCKS AND XS	GRAPHIC FINE ROCKS AND XS	GRAPHIC ROCKS	CRYSTAL INTARSIA (foil print only)
Max. motif size	400x330 mm	400x330 mm	400x330 mm	400x330 mm	400x330 mm
Min. motif size	10x10 mm (or effective surface of 1 cm <sup>2</sup> )	15x15 mm (or effective surface of 2.25 cm <sup>2</sup> ; for XS 0.64 cm <sup>2</sup> )	15x15 mm (or effective surface of 2.25 cm <sup>2</sup> ; for XS 1.0 cm <sup>2</sup> )	15x15 mm (or effective surface of 2.25 cm <sup>2</sup> )	10x10 mm (or effective surface of 1 cm <sup>2</sup> )
Min. width of gaps within motifs	3 mm	3 mm	3 mm	3 mm	3 mm
Min. product surface	3 mm	3.4 mm	4 mm	9 mm	3 mm
Min. size of the smallest element within a motif	10x10 mm (or effective surface of 1 cm <sup>2</sup> )	15x15 mm (or effective surface of 2.25 cm <sup>2</sup> ; for XS 0.64 cm <sup>2</sup> )	15x15 mm (or effective surface of 2.25 cm <sup>2</sup> ; for XS 1.0 cm <sup>2</sup> )	15x15 mm (or effective surface of 2.25 cm <sup>2</sup> )	10x10 mm (or effective surface of 1 cm <sup>2</sup> )

Due to production requirements, motifs with edges and angles of less than 90° need to be rounded off.

### Ordering Process

Send your request with the drawing you wish to order to your nearest Swarovski sales office. Make sure you include all measurements for the desired motif. Please also indicate which product group your special motif applies to (Graphic Fabric, Ultrafine Rocks, Fine Rocks & Rocks).

You will then receive a quotation including your article number, minimum order quantity, price, and the line

drawing of your special motif in PDF format. Please contact your Swarovski sales office again if any changes are required.

Your special motif will be produced and delivered following your confirmation.

### Important information

Please always submit the drawing of your desired motif in the actual size you require. When enlarged to the desired size, a small sketch will have blurred lines that will make it difficult to correctly reproduce. Full-scale pictures or drawings representing 100% size of the design or very good quality scans in JPG, BMP, or DXF format will ensure that we have clear data to work with. These can also be sent via email. If sending a sewing pattern, please include the whole pattern and not just sections. If the sketch is submitted as a copy by email, please include a scale legend (e.g. copy/scan with a ruler next to the drawing). This will ensure that the desired size of the motif can be identified.

Due to the tolerance level of the crystals being applied onto carrier film, the final Graphic Fabric, Ultrafine Rocks, Fine Rocks, and Rocks motifs may slightly differ from the sketches or prints in relation to the motifs' outline. Therefore the product may be subject to individual variations with each reproduction. These variations are caused by technical production-related factors. As these variations are not deemed to be defects, warranty

claims are excluded and Swarovski assumes no liability whatsoever in connection with them.

If detailed information on possible tolerances (e.g. cavity production for metal parts) and print tolerances is required (offset, color tolerance, etc.), please contact Swarovski and an application request will be placed in our application database.

If considered feasible, special productions are generally offered to all our customers. Please note: special productions are subject to acceptance by Swarovski and ordering a design does not automatically grant exclusive production of this design for the customer.

For detailed application information, please refer to the Application Manual or contact your Swarovski sales office.

Please take care with deep-colored fabrics and artificial leather (e.g. denim and alcantara). Some fabrics may bleed after application or washing. If detailed information is required (product information), please contact Swarovski, who will enter an application request into our application database.

**INTO THE WILD WITH THE SWAROVSKI EXOTICS COLLECTION**

Elegant and ethical, the SWAROVSKI EXOTICS collection presents a reimagining of Crystal Textures in a sparkling safari of animal prints.

In a world where conscious luxury is essential, where animal skins are no longer desirable or considered to be symbols of prestige, SWAROVSKI EXOTICS provides an enlightened choice. It offers our clients new possibilities for exclusive and unique creative expression, and a further way to elevate their products.

The Swarovski Limitless Crystal Printing Technology is an exclusive and intelligent printing technique, capable of

printing on the crystals, underneath the crystals, or a combination of both. This ensures complete customization and design innovation, merging crystals, colors, effects and multi-directional prints to create an illusion of mesmerizing 3D texture.

The result of 125 years of expertise and advanced technology, combined with a love of innovation and artistry, the SWAROVSKI EXOTICS Collection is an unparalleled creative alternative to leather embossment, animal and reptile skins.

**STANDARD COLLECTION GRAPHIC FABRIC**

Graphic - Swarovski Exotics Collection

**57 419**



**C** 022-FP21221 001M500  
**S** ~80x15  
**M** 52 PCS **50%**

**57 419**



**C** 022-FP21222 001M500  
**S** ~80x15  
**M** 52 PCS **50%**

STANDARD COLLECTION ULTRAFINE ROCKS

Crocodilia

89 956

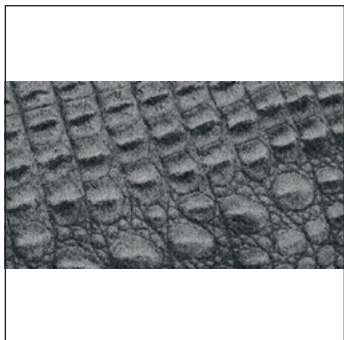

C 010-FP23143 001M126  
 S ~200x110  
 M 3 PCS 22%

89 956



C 010-FP23144 001M126  
 S ~200x110  
 M 3 PCS 22%

89 956

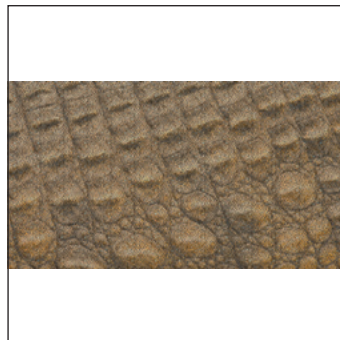

C 010-FP23142 001M126  
 S ~200x110  
 M 3 PCS 22%

89 956

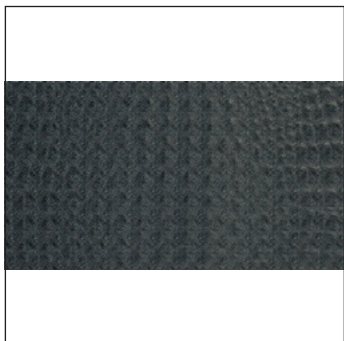

C 010-FP23154 001M126  
 S ~200x110  
 M 3 PCS 22%

89 956

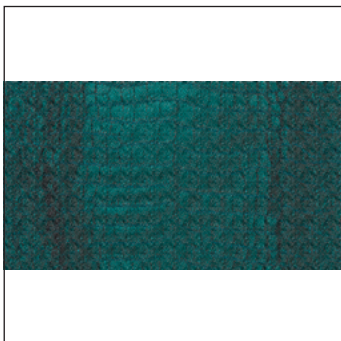

C 010-FP23145 001M126  
 S ~200x110  
 M 3 PCS 22%

89 956

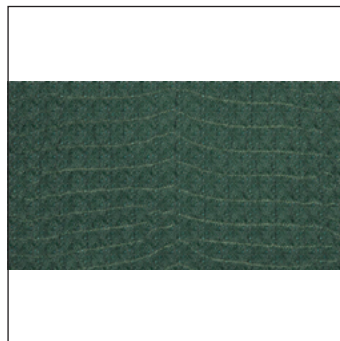

C 010-FP23146 001M126  
 S ~200x110  
 M 3 PCS 22%

**Feline**

**89 956**



**C** 022-FP23123 001M126  
**S** ~200x110  
**M** 3 PCS **22%**

**89 956**

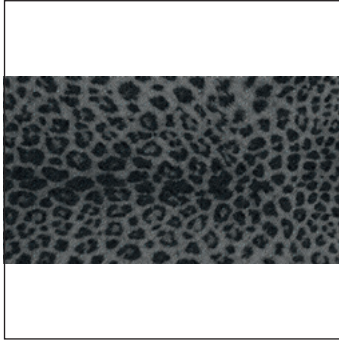

**C** 022-FP23151GP23152 001M126  
**S** ~200x110  
**M** 3 PCS **22%**

**89 956**

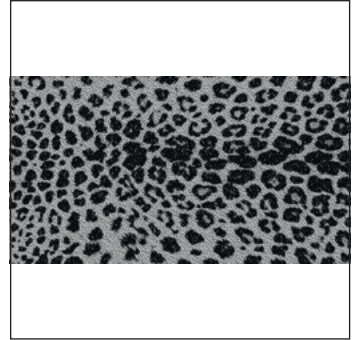

**C** 012-GP23160OP 280  
**S** ~200x110  
**M** 3 PCS **22%**

Graphic - Swarovski Exotics Collection

**Serpents**

**89 956**



**C** 022-FP20896 001M126  
**S** ~200x110  
**M** 3 PCS **22%**

**89 956**



**C** 022-FP23153 001GSHA  
**S** ~200x110  
**M** 3 PCS **22%**

**89 956**

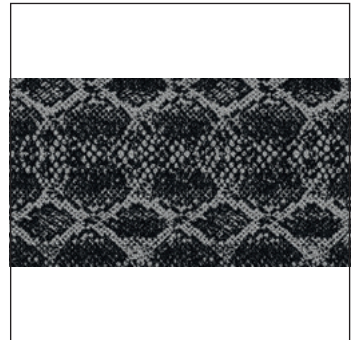

**C** 012-GP23161OP 280  
**S** ~200x110  
**M** 3 PCS **22%**

**89 956**

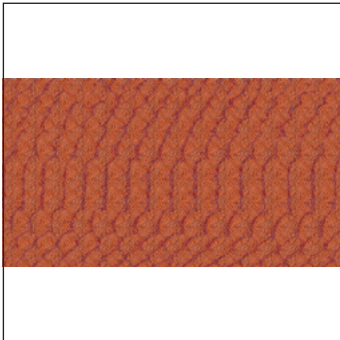

**C** 022-FP23156 001M126  
**S** ~200x110  
**M** 3 PCS **22%**

**89 956**



**C** 012-GP23162OP 280  
**S** ~200x110  
**M** 3 PCS **22%**

**89 956**

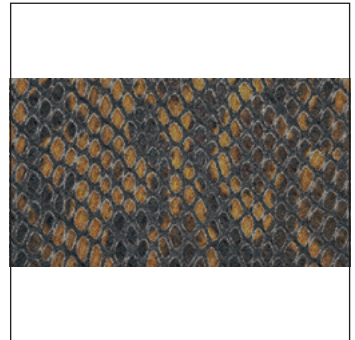

**C** 022-FP23158 001M126  
**S** ~200x110  
**M** 3 PCS **22%**

89 956

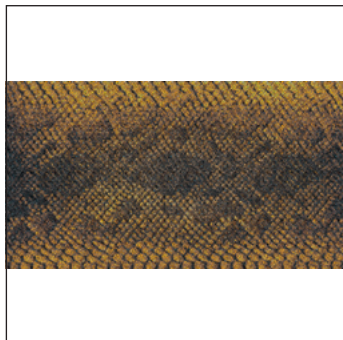

C 022-FP23159 001M126  
 S ~200x110  
 M 3 PCS **22%**

The Sea

89 956

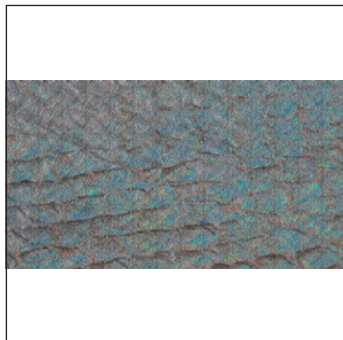

C 022-FP23120 001M126  
 S ~200x110  
 M 3 PCS **22%**

89 956

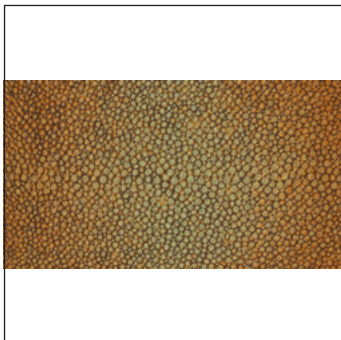

C 022-FP23165GP23164 001M126  
 S ~200x110  
 M 3 PCS **22%**

89 956

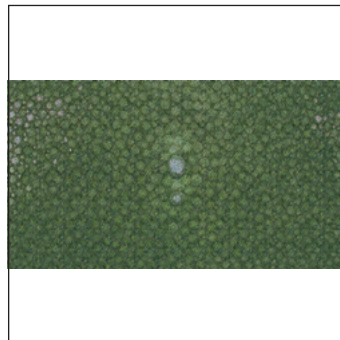

C 010-FP23166 001M126  
 S ~200x110  
 M 3 PCS **22%**

10

89 956

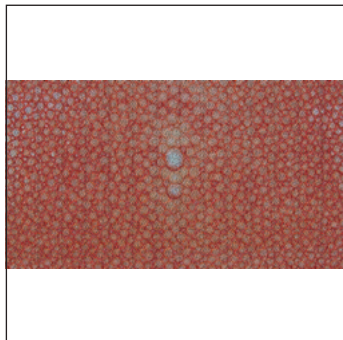

C 010-FP23167 001M126  
 S ~200x110  
 M 3 PCS **22%**

**Equine**

**89 956**

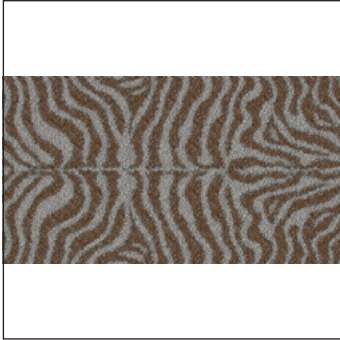

**C** 022-FP23116 001SSHA  
**S** ~200x110  
**M** 3 PCS **22%**

**89 956**



**C** 012-GP23141OP 280  
**S** ~200x110  
**M** 3 PCS **22%**

**Hybrids**

**89 956**



**C** 022-FP23123GP23122 001M126  
**S** ~200x110  
**M** 3 PCS **22%**

**89 956**

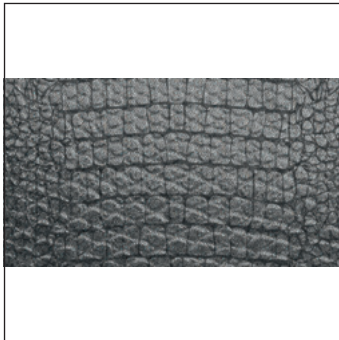

**C** 022-FP23149GP23150 001M126  
**S** ~200x110  
**M** 3 PCS **22%**

**The Deep**

**89 956**

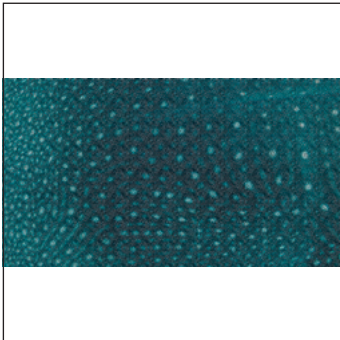

**C** 010-FP23163 001M126  
**S** ~200x110  
**M** 3 PCS **22%**

**Cingulata**

**89 956**

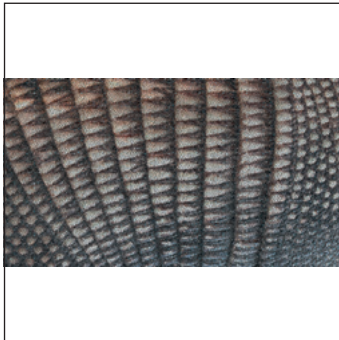

**C** 010-FP23135 001M126  
**S** ~200x110  
**M** 3 PCS **22%**

**Testudines**

**89 956**

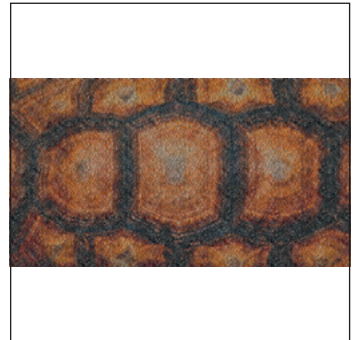

**C** 022-FP23117 001SSHA  
**S** ~200x110  
**M** 3 PCS **22%**



# Crystal Textures Special Product Features

## LACQUERED FOILS

The Crystal Lacquered Foils combine the shine of our Crystal Textures with customizable lacquer colors, opening up a new world of endless color possibilities.

Transforming any chosen Pantone color in a new sparkling color variant for our Crystal Fabric, Crystal Rocks and Crystal Medley families, they provide the best solution when looking for the perfect color match.

They are ideal for monochromatic motifs with lower tolerances, improved color quality and maximum customization flexibility.

Standard colors are ready for reference. Customization possibilities are available through our Customer Service.

Please be aware that this unique technology cannot be combined with XS, Unlimited or Foil Overlay.



**Burgundy**  
(Pantone  
19-2524 TPX)  
622F53



**Laguna Emerald**  
(Pantone  
17-5130 TPX)  
00958A



**Light Coral**  
(Pantone  
16-1451 TPX)  
F6624C



**Ocean Blue**  
(Pantone  
18-4039 TPX)  
4D7CBC



**Pink**  
(Pantone  
PMS 203 C)  
ECB3CB



**Royal Red**  
(Pantone  
19-1763 TCX)  
B81B36

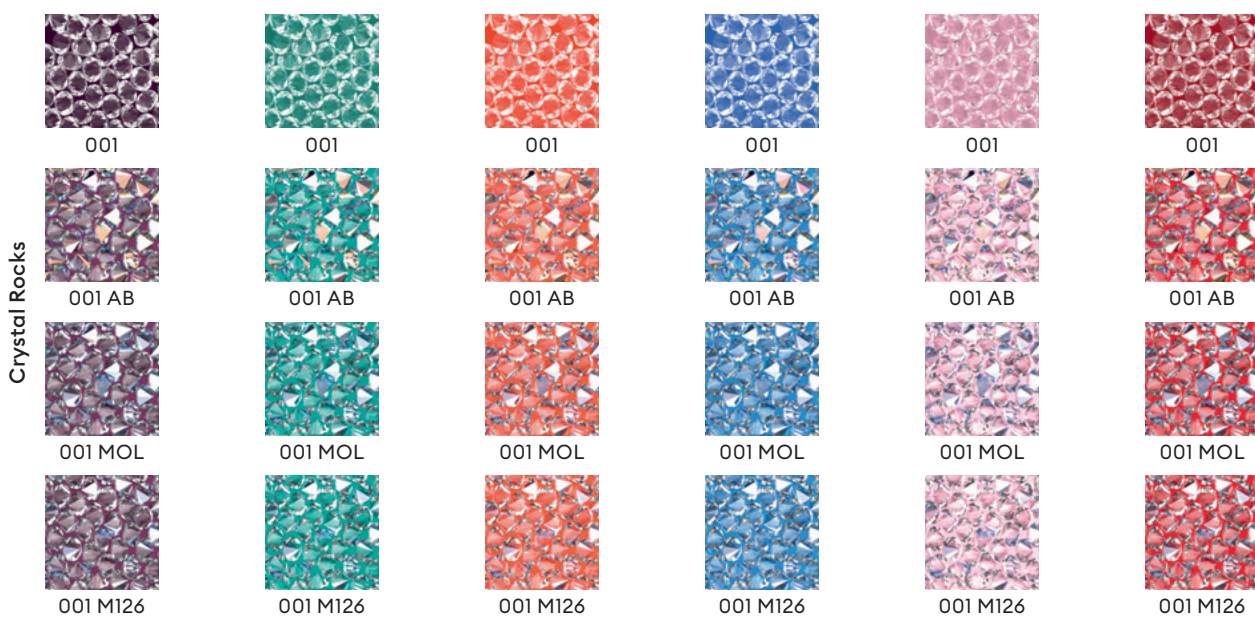
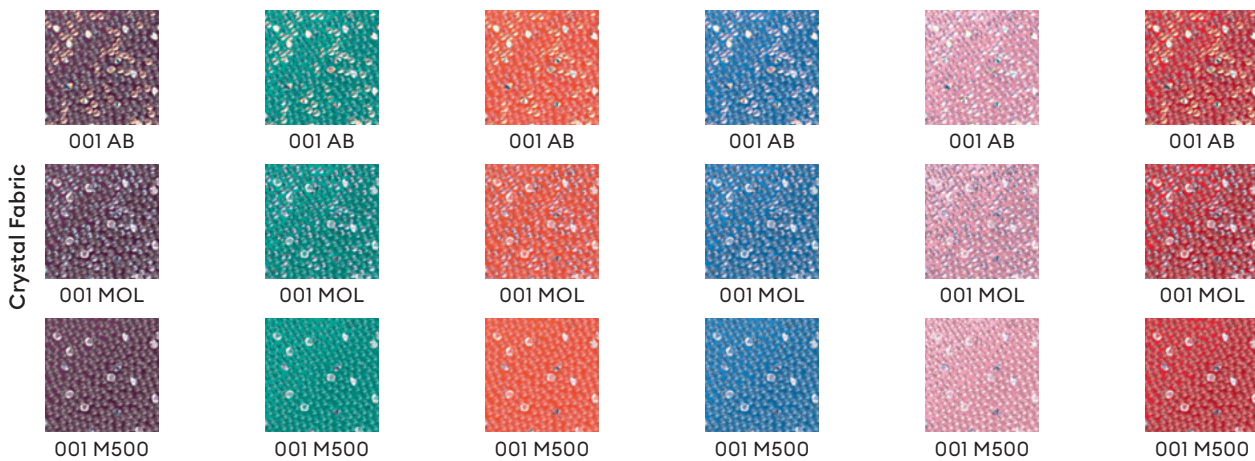

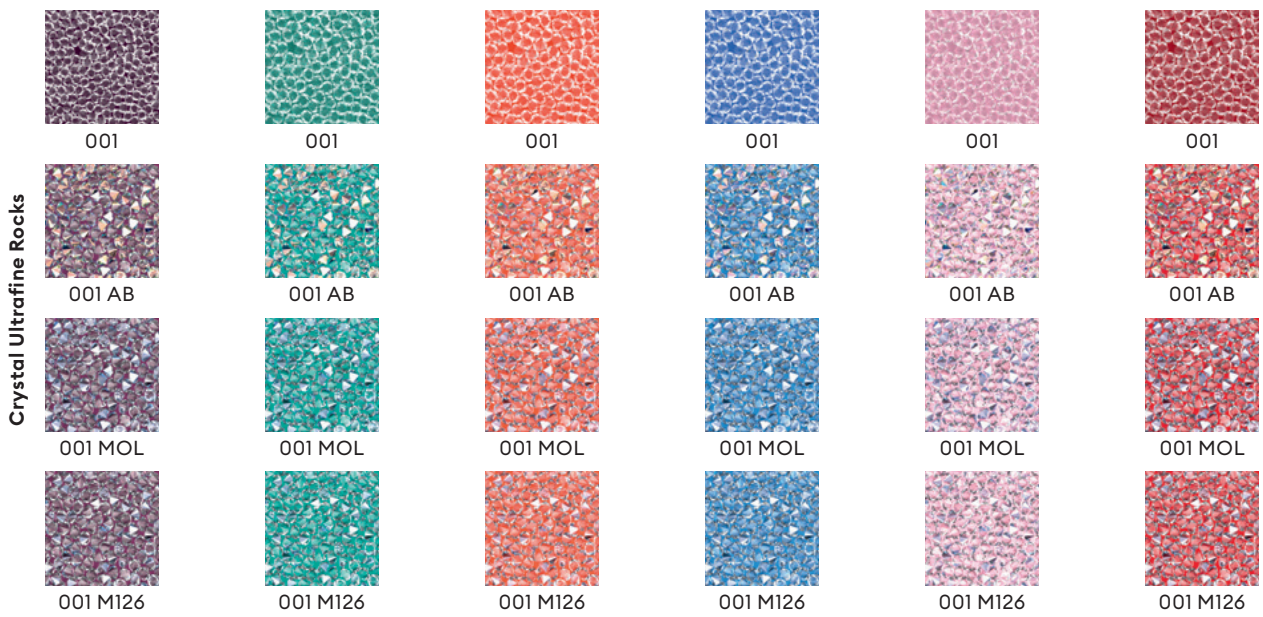
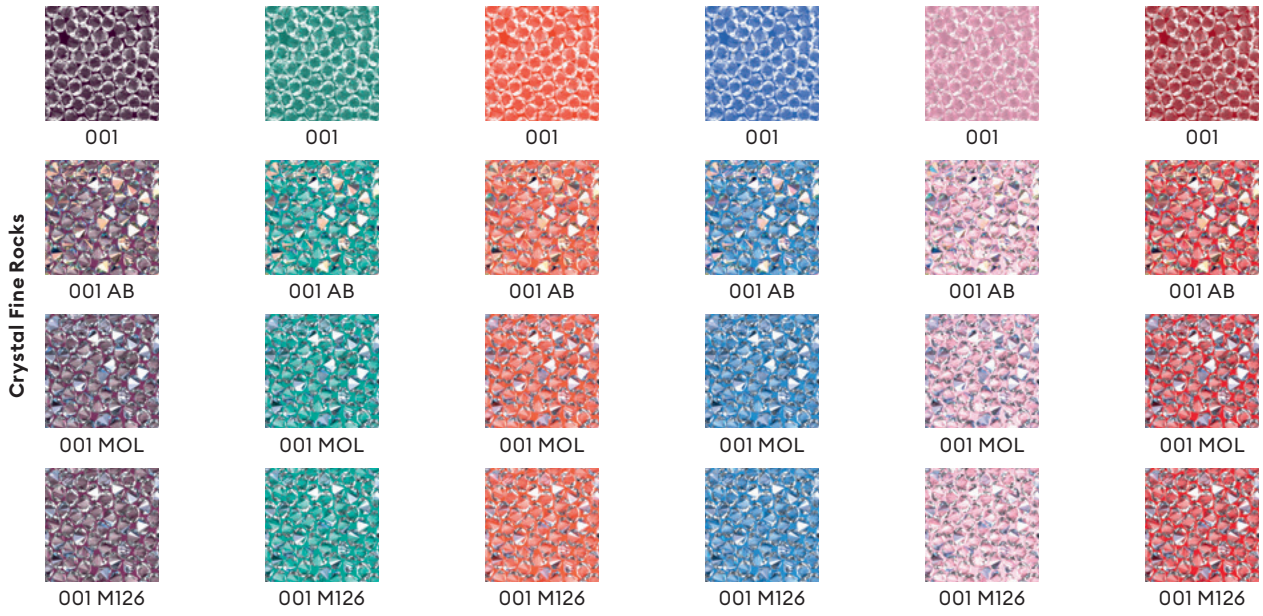

INSPIRATIONAL MOTIFS

Crystal Fabric

57 335

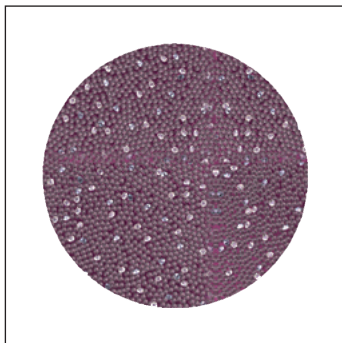

<b>C</b>	H-622F53 001M500
<b>S</b>	~35x35
<b>M</b>	147 PCS <b>100%</b>

57 423



<b>C</b>	H-00958A-001M500
<b>S</b>	~107x172
<b>M</b>	18 PCS <b>25%</b>

Crystal Fine Rocks

74 043

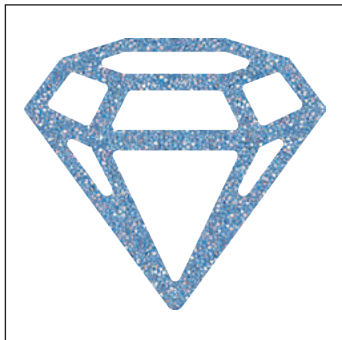

<b>C</b>	H-4D7CBC 001AB
<b>S</b>	~89x79
<b>M</b>	16 PCS <b>45%</b>

**Crystal Ultrafine Rocks**

**89 959**

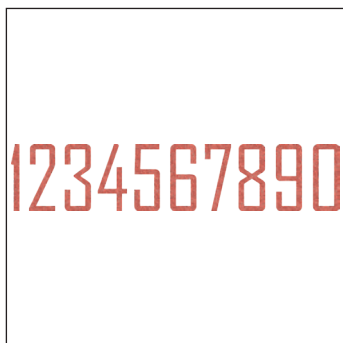

**C** H-F6624C-001  
**S** ~241x49  
**M** 7 PCS **18%**

**89 961**



**C** H-ECB3CB-001  
**S** ~77x50  
**M** 20 PCS **55%**

**LACQUERED FOILS WITH ELECTRIC LACQUER<sup>PRO</sup> EFFECTS**

High-voltage hues are on the ascension as our Lacquered Foils with Electric Lacquer<sup>PRO</sup> Effects take dopamine dressing to a whole new level. A desire to stand-out and step-forward forms the effervescent undercurrent to an electrifying revived style aesthetic that takes its cue from '80s neons, sending them further into the stratosphere.

Bold, beautiful and absolutely brilliant, these show-stopping Crystal Textures will ensure you shine bright – no matter how dark it gets.



Electric Yellow  
(001 L138S)  
FFFF00



Electric Blue  
(001 L134S)  
0097D6



Electric Pink  
(001 L137S)  
FF4FB1



Electric Violet  
(001 L148S)  
AB61C0



Electric Orange  
(001 L136S)  
FF5557



Electric White  
(001 L139S)  
D8DEE9

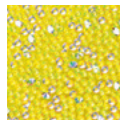

001 AB

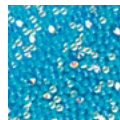

001 AB

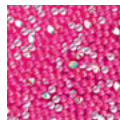

001 AB

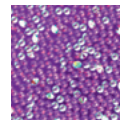

001 AB

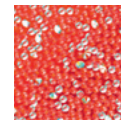

001 AB

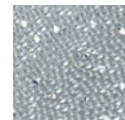

001 AB

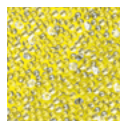

001 MOL

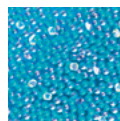

001 MOL

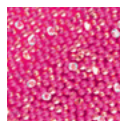

001 MOL

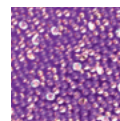

001 MOL

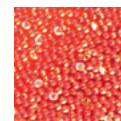

001 MOL

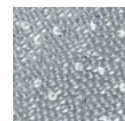

001 MOL

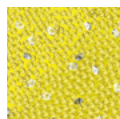

001 M500

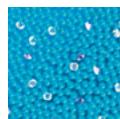

001 M500

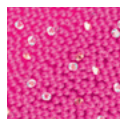

001 M500

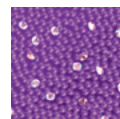

001 M500

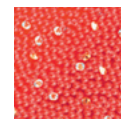

001 M500

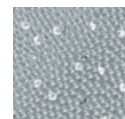

001 M500



001

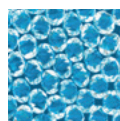

001



001

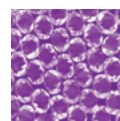

001

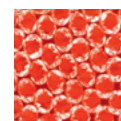

001

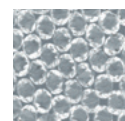

001

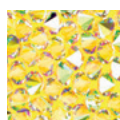

001 AB

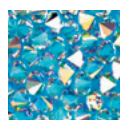

001 AB



001 AB

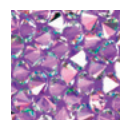

001 AB

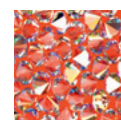

001 AB



001 AB



001 MOL

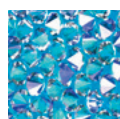

001 MOL



001 MOL

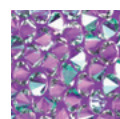

001 MOL

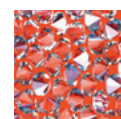

001 MOL



001 MOL



001 M126



001 M126



001 M126

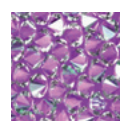

001 M126

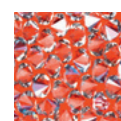

001 M126



001 M126

Crystal Fabric

Crystal Rocks

Crystal Fine Rocks

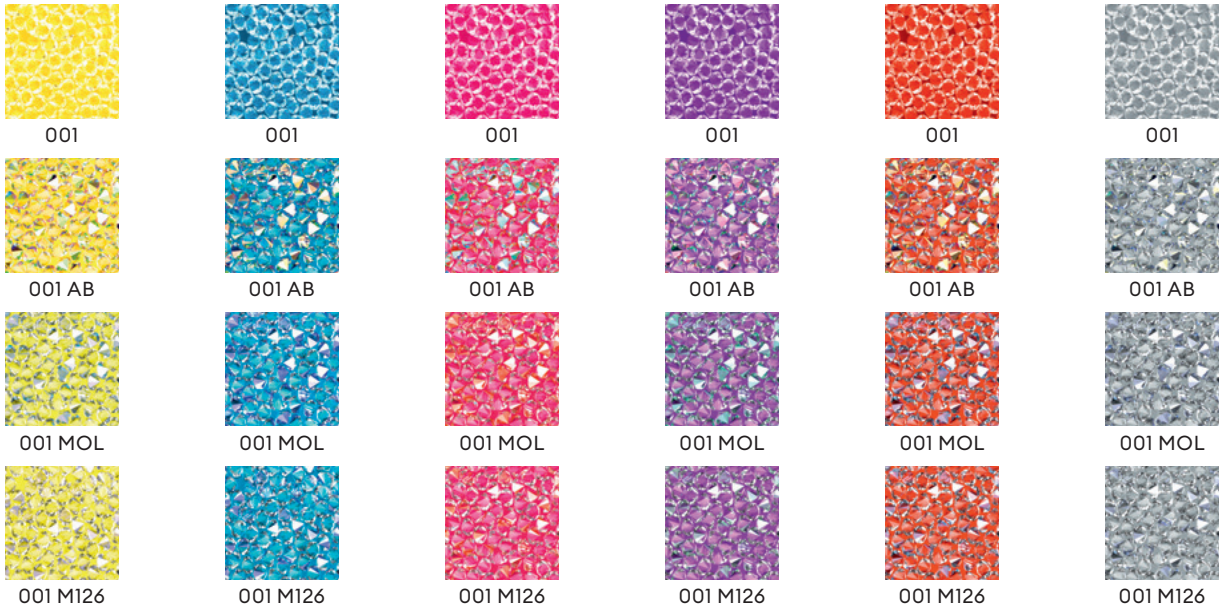

Crystal Ultrafine Rocks

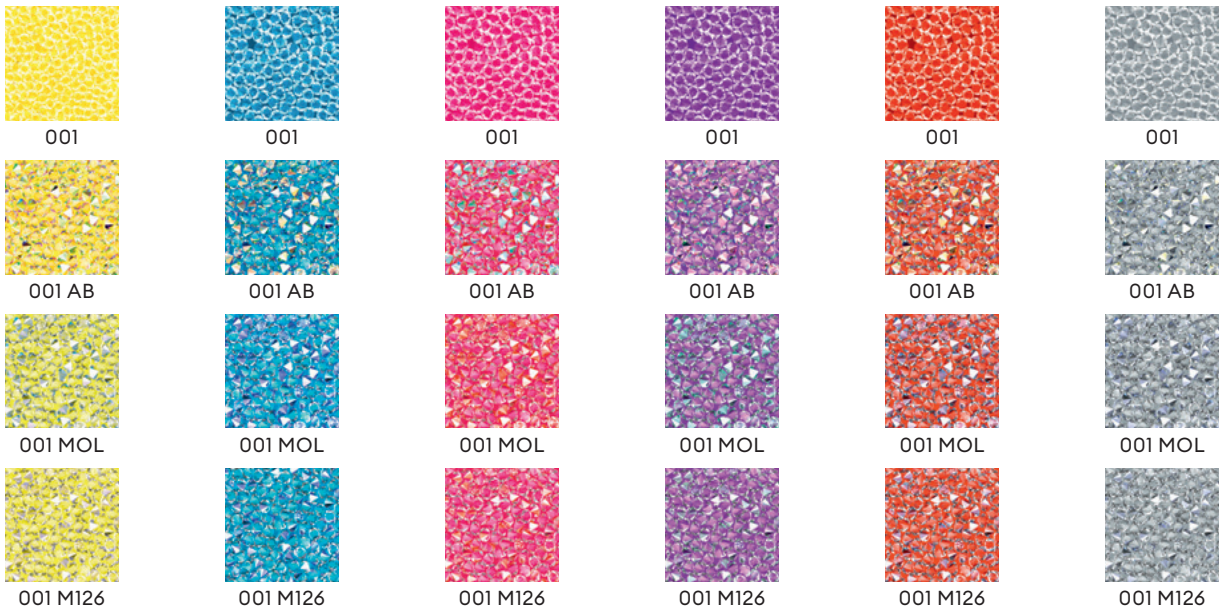

INSPIRATIONAL MOTIFS

Crystal Fabric

57 434

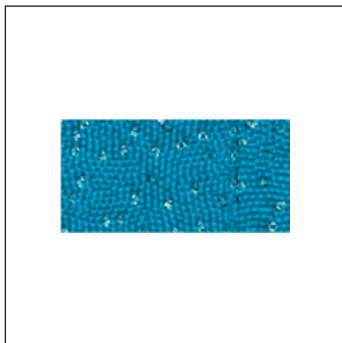

**C** H-0097D6 001M500  
**S** 30x15  
**M** 130 PCS **100%**

57 434

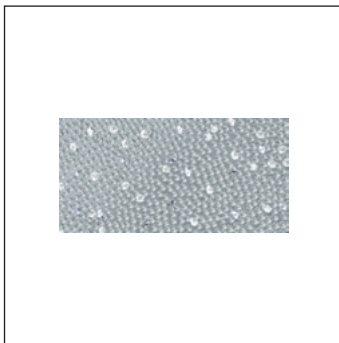

**C** H-D8DEE9 001 M500  
**S** 30x15  
**M** 130 PCS **100%**

Crystal Rocks

72 066

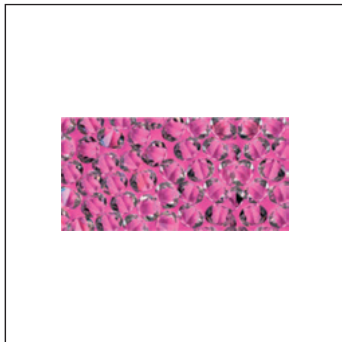

**C** H-FF4FB1 001M126  
**S** ~30x15  
**M** 140 PCS **100%**

**Crystal Fine Rocks**

**74 107**

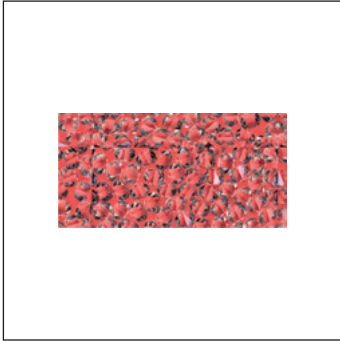

**C** H-FF5557 001 M126  
**S** ~30x15  
**M** 140 PCS **100%**

**74 107**

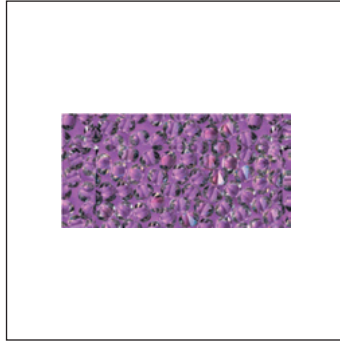

**C** H-AB61C0 001 M126  
**S** ~30x15  
**M** 140 PCS **100%**

**Crystal Ultrafine Rocks**

**89 965**



**C** H-FF5557-001  
**S** ~128x32  
**M** 20 PCS **33%**

**89 966**

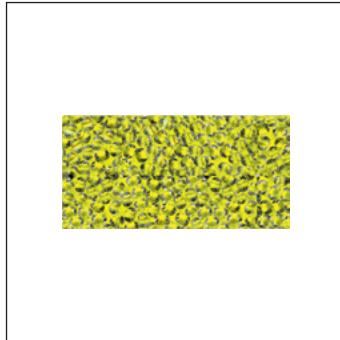

**C** H-FFFF00 001 M126  
**S** ~30x15  
**M** 140 PCS **100%**



## CRYSTAL TEXTURES EXTRA SMALL (XS)

### Crystal Fine Rocks XS & Crystal Ultrafine Rocks XS

Fans of filigree designs will love the extra small Crystal Fine Rocks and Crystal Ultrafine Rocks. Small, double-pointed Chatons create a refined surface structure and flexible texture that is thin and lightweight.

Now it is possible to order these products smaller than the current minimum size. Available colors according to the Fine Rocks and Ultra Fine rocks portfolio.

#### Standard (Crystal Fine Rocks & Crystal Ultrafine Rocks)

Current minimum size:  
15x15 mm (2.25 cm<sup>2</sup>)

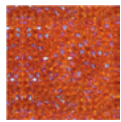

#### NEW XS sizes for Crystal Fine Rocks

New extra small (XS) minimum sizes:  
10x10 mm (1.0 cm<sup>2</sup>)



#### NEW XS sizes for Crystal Ultrafine Rocks

New extra small (XS) minimum size:  
8x8 mm (0.64 cm<sup>2</sup>)



**CRYSTAL FINE ROCKS XS**

**74 085**

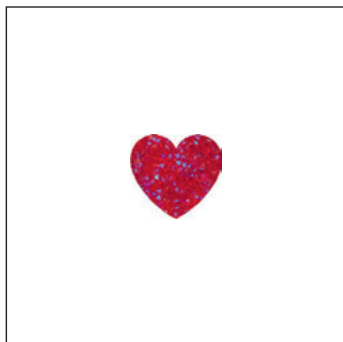

<b>C</b>	010-227SHIM XS
<b>S</b>	~12x11
<b>M</b>	306 PCS <b>100%</b>

<b>74 085</b>	<b>C</b>	<b>S</b>	<b>M</b>	<b>100%</b>
Article number	Color of crystals	Motif size in mm	Minimum order quantity in pieces (PCS)	% of actual size

**Ordering Example & Product Variety Explanation**

<b>74 085</b>		<b>010</b>	<b>227SHIM</b>	<b>XS</b>
Article number	Type of base material	Color of base material	Color of crystals	Extra Small
	Hotfix C Coldfix I It version R Removable foil	010 Transparent 012 Black	Please see the respective product matrix for all available reference codes.	

Inspirational Motifs

74 085

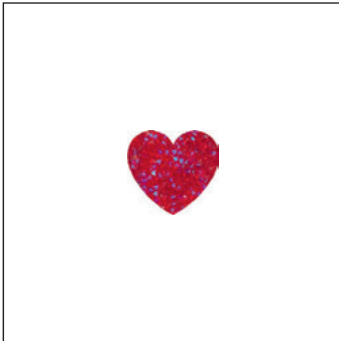

C 010-227SHIM XS  
S ~12x11  
M 306 PCS **100%**

74 092

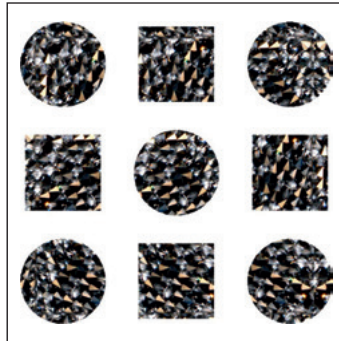

C 012-001SSHA XS  
S ~41x40  
M 48 PCS **100%**

74 093

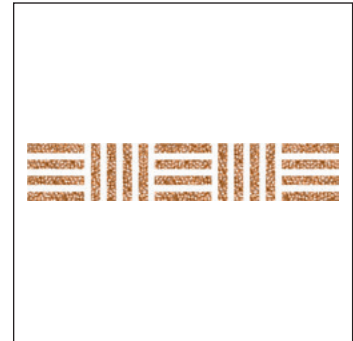

C 010-001GSHA XS  
S ~137x25  
M 24 PCS **30%**

74 094

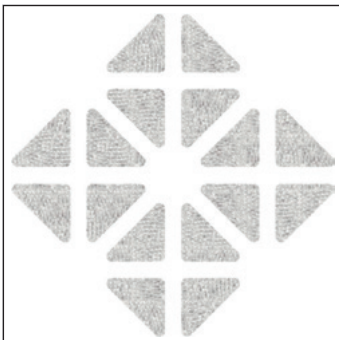

C 010-001 XS  
S ~71x71  
M 30 PCS **60%**

74 095

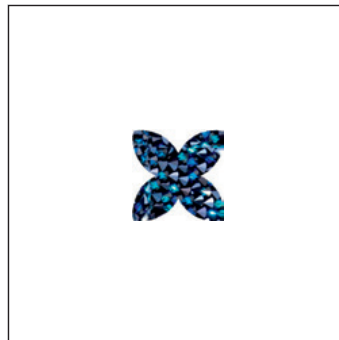

C 012-001BBL XS  
S ~12x12  
M 304 PCS **100%**

74 096



C 022-FP21290 001M126 XS  
S ~24x80  
M 40 PCS **50%**

74 097



C 022-FP21291 001M126 XS  
S ~79x95  
M 12 PCS **45%**

Please note: all motifs are available in certain color/film variations (see color matrix).

**CRYSTAL ULTRAFINE ROCKS XS**

**89 939**

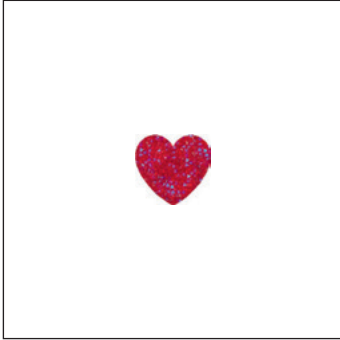

<b>C</b>	010-227SHIM XS
<b>S</b>	~10x9
<b>M</b>	396 PCS <b>100%</b>

<b>89 939</b>	<b>C</b>	<b>S</b>	<b>M</b>	<b>100%</b>
Article number	Color of crystals	Motif size in mm	Minimum order quantity in pieces (PCS)	% of actual size

**Ordering Example & Product Variety Explanation**

<b>89 939</b>		<b>010</b>	<b>227SHIM</b>	<b>XS</b>
Article number	Type of base material	Color of base material	Color of crystals	Extra Small
	Hotfix C Coldfix I It version R Removable foil	010 Transparent 012 Black 022 White (only available for White Alabaster)	Please see the respective product matrix for all available reference codes.	

Inspirational Motifs

89 939

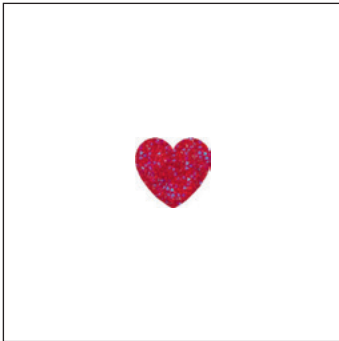

C 010-227SHIM XS  
S ~10x9  
M 396 PCS 100%

89 947

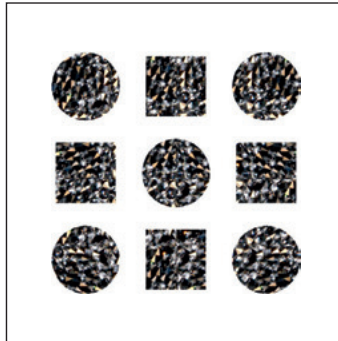

C 012-001SSHA XS  
S ~33x32  
M 72 PCS 100%

89 948

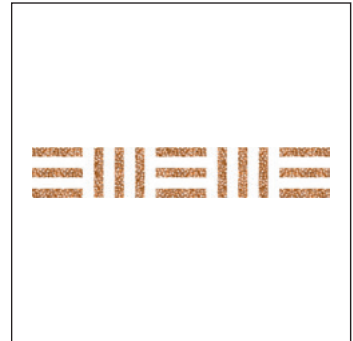

C 010-001GSHA XS  
S ~112x19  
M 36 PCS 35%

89 949

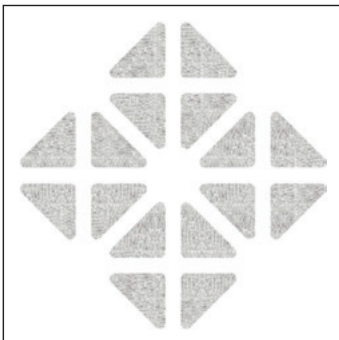

C 010-001 XS  
S ~58x58  
M 42 PCS 70%

89 950



C 012-001BBL XS  
S ~9x9  
M 396 PCS 100%

89 951

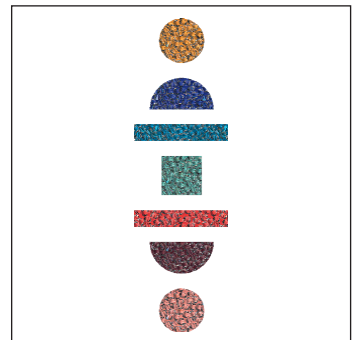

C 022-FP21292 001M126 XS  
S ~19x64  
M 60 PCS 65%

89 952



C 022-FP21293 001M126 XS  
S ~63x81  
M 16 PCS 50%

Please note: all motifs are available in certain color/film variations (see color matrix).

### SPECIAL MOTIF SERVICE

A special motif is a design created by the customer that differs to the Crystal Textures Inspirational Collection. This service opens up an abundance of customization possibilities and enables you to profit from Swarovski's long-standing experience and design

expertise. A range of customization options for existing motifs is available (see "Customization Possibilities" below). You can also submit design sketches that meet your special needs, such as a brand image or an image for a particular sales campaign. This will

then be made up according to your specifications using Computer Aided Design, which means that adjustments can be made easily according to your needs.

#### Customization Possibilities for the respective product groups

	Ultrafine Rocks	Fine Rocks
Min. surface (width)	3.4 mm	4.0 mm
Min. size or effective surface:	8x8 mm (0.64 cm <sup>2</sup> )	10x10 mm (1.00 cm <sup>2</sup> )
Max. size:	400x330 mm	
Min. width of gaps within motifs:	3.0 mm	3.0 mm
Edges & angles less than =/< 90° need to be rounded off [diameter]	2.0 mm	2.7 mm

#### Ordering Process

Send your request with the drawing you wish to order to your nearest Swarovski sales office. Make sure you include all measurements for the desired motif. Please also indicate which product

group your special motif applies to. You will then receive a quotation including your article number, minimum order quantity, price, and the line drawing of your special motif in PDF format. Please

contact your Swarovski sales office again if any changes need to be made. Your special motif will be produced and delivered following your confirmation.

#### Please Note

Please always submit the drawing of your desired motif to represent it in the actual size you require. A small sketch, when enlarged to the desired size, will have blurred lines that will make it difficult to correctly reproduce. Pictures or drawings representing 100% size of the design or very good quality scans in JPG, BMP, or DXF format will ensure that we have clear data to work with. These can also be sent via email. If sending a sewing pattern, please include the whole pattern and not just sections. When the sketch is submitted as a copy by email, please include a scale legend (e.g. copy/scan with a ruler next to the drawing). This will

ensure that the desired size of the motif can be identified.

It is generally possible to draw motifs with a minimum gap between the outlines. However, due to the tolerance level of the crystals being applied onto carrier film, the final Crystal Textures motifs may differ from the sketches or prints in relation to the motifs' outline. Therefore the motif, and by extension, the product itself, may be subject to individual variations with each reproduction. These variations are caused by technical production-related factors. As these variations are not deemed to be defects, warranty

claims are excluded and Swarovski assumes no liability whatsoever in connection with them.

Special productions are generally offered to all our customers if these are deemed to be feasible and comply with our General Terms and Conditions. Please note that ordering of a design does not grant exclusive production of this design to the customer. If detailed information on possible tolerances is required (e.g. cavity production for metal parts), please contact your local Swarovski sales office who will enter an application request into our application database.

## CRYSTAL TEXTURES UNLIMITED

### Crystal Fabric UL

Crystal Textures Unlimited (UL) is the solution that offers a totally new and sophisticated look.

Due to a new production technology it is possible to create more precise designs with sharper edges and a more luxurious look.

This will lead to fewer gaps and will perfectly fit when inserting into cavities.

Additional rework is not necessary, which therefore saves time.

Unlimited (UL) will be offered for:

- Crystal Fabric UL

And could be ordered in following application versions:

- Hotfix
- Self-Adhesive (IT)\*
- Coldfix (C)

Please note that the Unlimited (UL) technique is only available for motifs (no bandings) and could not combined with Graphic prints.

Standard Crystal Fabric

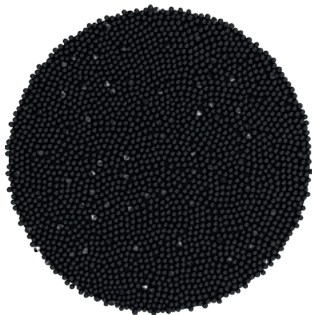

Crystal Fabric Unlimited (UL)

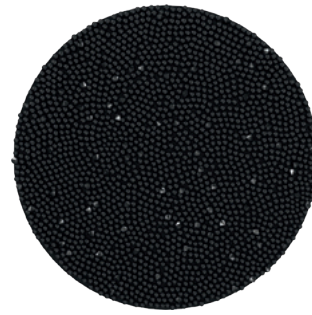

\* IT is only available for Crystal Fabric UL

**CRYSTAL FABRIC UNLIMITED (UL)**

**57 411**

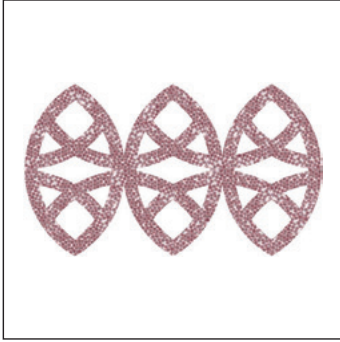

<b>C</b>	010-001 ANTP UL
<b>S</b>	~72x42
<b>M</b>	72 PCS <b>55%</b>

<b>57 411</b>	<b>C</b>	<b>S</b>	<b>M</b>	<b>55%</b>
Article number	Color of crystals	Motif size in mm	Minimum order quantity in pieces (PCS)	% of actual size

**Ordering Example & Product Variety Explanation**

<b>57 411</b>		<b>010</b>	<b>001 ANTP</b>	<b>UL</b>
Article number	Type of base material	Color of film	Color of crystals	Unlimited
	Hotfix C Coldfix I It version	010 Transparent 012 Black	Please see the relevant product matrix for all available reference codes.	



Crystal Fabric Unlimited (UL) Motifs

57 409

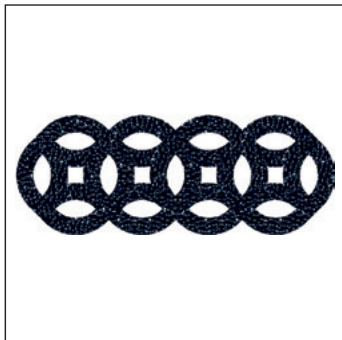

C 012-280HEM UL  
 S ~56x21  
 M 150 PCS 75%

57 410



C 010-001GSHA UL  
 S ~234x28  
 M 32 PCS 18%

57 411

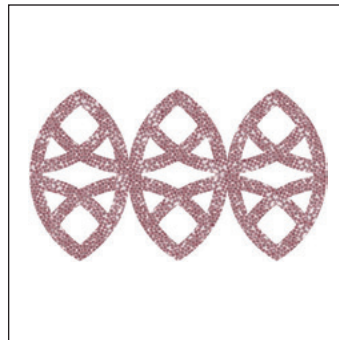

C 010-001ANTP UL  
 S ~72x42  
 M 72 PCS 55%

57 412



C 012-001PARSH UL  
 S ~65x64  
 M 52 PCS 60%

57 413

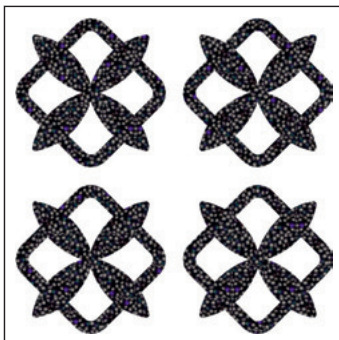

C 012-001HEL UL  
 S ~76x76  
 M 33 PCS 55%

57 414

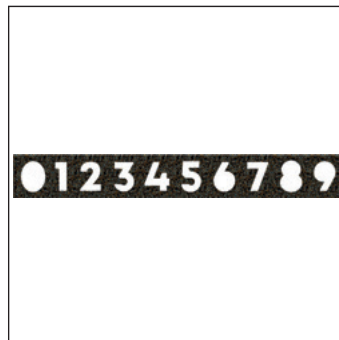

C 012-280 UL  
 S ~174x22  
 M 20 PCS 25%

Please note: all motifs are available in certain color/film variations (see color matrix).

## SPECIAL MOTIF SERVICE

A special motif is a design created by the customer that differs to the Crystal Textures Inspirational Collection. This service opens up an abundance of customization possibilities and enables you to profit from Swarovski's long-standing experience and design expertise. A range of customization options for existing motifs is available (see

“Customization Possibilities” below). You can also submit design sketches that meet your special needs, such as a brand image or an image for a particular sales campaign. This will then be made up according to your specifications using Computer Aided Design, which means that adjustments can be made easily according to your needs.

### Customization Possibilities for Crystal Fabric

- Min. surface (width): 3.0 mm
- Min. size or effective surface: 10x10 mm (1.0 cm<sup>2</sup>)
- Max. size: 400x330 mm
- Min. width of gaps within motifs: 3.0 mm
- Edges & angles less than  $\neq$  90° need to be rounded off [diameter]: 1.5 mm

### Ordering Process

Send your request with the drawing you wish to order to your nearest Swarovski sales office. Make sure you include all measurements for the desired motif. Please also indicate which product group your special motif applies to. You will then receive a quotation including your article number,

minimum order quantity, price, and the line drawing of your special motif in PDF format. Please contact your Swarovski sales office again if any changes need to be made. Your special motif will be produced and delivered following your confirmation.

### Please Note

Please always submit the drawing of your desired motif to represent it in the actual size you require. A small sketch, when enlarged to the desired size, will have blurred lines that will make it difficult to correctly reproduce. Pictures or drawings representing 100% size of the design or very good quality scans in JPG, BMP, or DXF format will ensure that we have clear data to work with. These can also be sent via email. If sending a sewing pattern, please include the whole pattern and not just sections. When the sketch is submitted as a copy by email, please include a scale legend (e.g. copy/scan with a ruler next to the drawing). This will ensure that the desired size of the motif can be identified.

or prints in relation to the motifs' outline. Therefore the motif, and by extension, the product itself, may be subject to individual variations with each reproduction. These variations are caused by technical production-related factors. As these variations are not deemed to be defects, warranty claims are excluded and Swarovski assumes no liability whatsoever in connection with them.

It is generally possible to draw motifs with a minimum gap between the outlines. However, due to the tolerance level of the crystals being applied onto carrier film, the final Crystal Textures motifs may differ from the sketches

Special productions are generally offered to all our customers if these are deemed to be feasible and comply with our General Terms and Conditions. Please note that ordering of a design does not grant exclusive production of this design to the customer.

If detailed information on possible tolerances is required (e.g. cavity production for metal parts), please contact your local Swarovski sales office who will enter an application request into our application database.

**FOIL OVERLAY FOR CRYSTAL FABRIC, CRYSTAL ROCKS, CRYSTAL FINE ROCKS & CRYSTAL ULTRAFINE ROCKS**

The fashion-forward Crystal Textures Foil Overlay is heaven-sent as it offers new fabrications in fantastic shapes to usher in a new era of “Techility” inspired designs.

This new “foil overlay” technology is a forward integration that opens totally new ways in terms of flexibility and use of – until now – impossible materials. With the overlay, it is now possible to sew or glue the motifs onto tricky

materials, e.g. leather. It is perfectly possible to create one flat surface while integrating the products into the standard production process.

Foil overlay will be offered for Crystal Fabric, Crystal Rocks, Crystal Fine Rocks and Crystal Ultrafine Rocks.

Please note that the Foil Overlay technique is only available for motifs (no bandings) and only for the Hotfix version (not available for Coldfix and IT).

**ARTICLE EXPLANATION - CRYSTAL FABRIC**

57 396

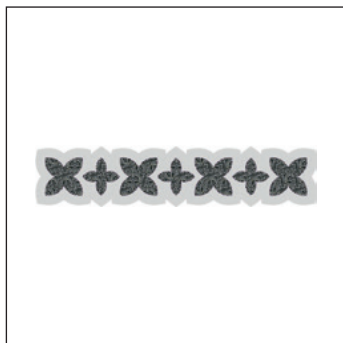

**C** 012-001CAL FO  
**S** ~149x32  
**M** 18 PCS **25%**

57 396	C	S	M	25%
Article number	Color of crystals	Motif size in mm	Minimum order quantity in pieces (PCS)	% of actual size

**Ordering Example & Product Variety Explanation**

57 396	012	001 CAL	FO	
Article number	Type of base material Hotfix	Color of film 010 Transparent 012 Black	Color of crystals Please see the respective product matrix for all available reference codes.	Foil overlay

Crystal Fabric Motifs

57 396

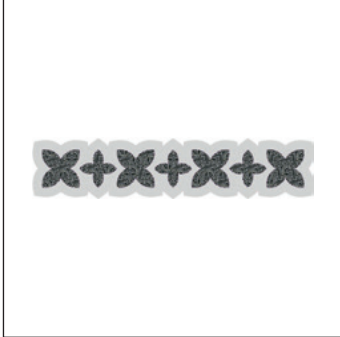

<b>C</b>	012-001CAL FO
<b>S</b>	~149x32
<b>M</b>	18 PCS <b>25%</b>

57 397

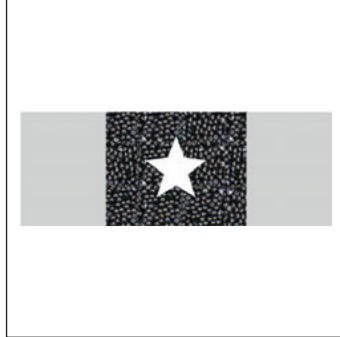

<b>C</b>	012-001CHRM FO
<b>S</b>	~55x20
<b>M</b>	66 PCS <b>75%</b>

57 398

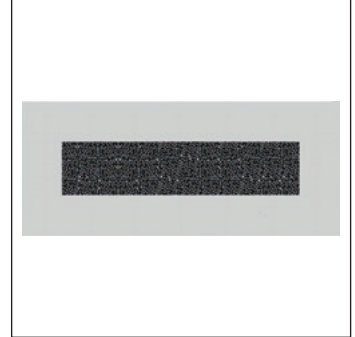

<b>C</b>	012-001CHRM FO
<b>S</b>	~120x50
<b>M</b>	15 PCS <b>35%</b>

57 399



<b>C</b>	012-280HEM FO
<b>S</b>	~55x50
<b>M</b>	30 PCS <b>75%</b>

Crystal Textures Special Product features – Foil Overlay

Please note: All motifs are available in certain color/film variations (see color matrix).

ARTICLE EXPLANATION - CRYSTAL ROCKS MOTIFS

72 054



<b>C</b>	012-280 FO
<b>S</b>	~66x63
<b>M</b>	30 PCS <span style="float: right;">65%</span>

72 054	C	S	M	65%
Article number	Color of crystals	Motif size in mm	Minimum order quantity in pieces (PCS)	% of actual size

Ordering Example & Product Variety Explanation

10

72 054	012	280	FO
Article number	Type of base material Hotfix	Color of film 010 Transparent 012 Black	Color of crystals Please see the respective product matrix for all available reference codes.
			Foil overlay

Crystal Rocks Motifs

72 054



<b>C</b>	012-280 FO
<b>S</b>	~66x63
<b>M</b>	30 PCS <span style="float: right;">65%</span>

Please note: All motifs are available in certain color/film variations (see color matrix).

**ARTICLE EXPLANATION - CRYSTAL FINE ROCKS MOTIFS**

**74 070**



<b>C</b>	012-280 FO
<b>S</b>	~55x50
<b>M</b>	30 PCS <b>75%</b>

Crystal Textures Special Product features – Foil Overlay

<b>74 070</b>	<b>C</b>	<b>S</b>	<b>M</b>	<b>75%</b>
Article number	Color of crystals	Motif size in mm	Minimum order quantity in pieces (PCS)	% of actual size

**Ordering Example & Product Variety Explanation**

<b>74 070</b>	<b>012</b>	<b>280</b>	<b>FO</b>	
Article number	Type of base material Hotfix	Color of film 010 Transparent 012 Black	Color of crystals Please see the respective product matrix for all available reference codes.	Foil overlay

**Crystal Fine Rocks Motifs**

**74 070**



<b>C</b>	012-280 FO
<b>S</b>	~55x50
<b>M</b>	30 PCS <b>75%</b>

Please note: All motifs are available in certain color/film variations (see color matrix).

ARTICLE EXPLANATION - CRYSTAL ULTRAFINE ROCKS MOTIFS

89 928



<b>C</b>	010-227SHIM FO
<b>S</b>	~75x42
<b>M</b>	28 PCS <b>45%</b>

89 928	C	S	M	55%
Article number	Color of crystals	Motif size in mm	Minimum order quantity in pieces (PCS)	% of actual size

Ordering Example & Product Variety Explanation

10

89 928	010	227 SHIM	FO	
Article number	Type of base material Hotfix	Color of film 010 Transparent 012 Black	Color of crystals Please see the respective product matrix for all available reference codes.	Foil overlay

Crystal Ultrafine Rocks Motifs

89 928

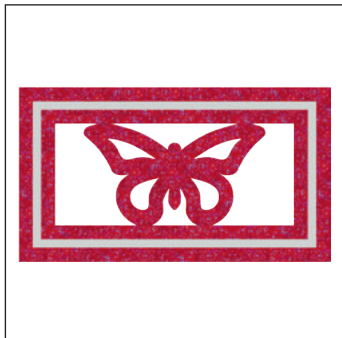

<b>C</b>	010-227SHIM FO
<b>S</b>	~75x42
<b>M</b>	28 PCS <b>55%</b>

Please note: All motifs are available in certain color/film variations (see color matrix).

## SPECIAL MOTIF SERVICE

A special motif is any individual design created by the customer that differs to the Crystal Textures Inspirational or Special Collections. This service opens up an abundance of customization possibilities and enables you to profit from Swarovski's long-standing experience and design expertise. A range of customization options for existing motifs is available (see "Customization Possibilities" below).

You can also submit design sketches that meet your special requirements, such as a brand image or an image for a particular sales campaign. This will then be made up according to your specifications using Computer Aided Design, which means that adjustments can be made easily according to your needs.

Customization Possibilities for the respective product groups	Crystal Fabric	Crystal Ultrafine Rocks	Crystal Fine Rocks	Crystal Rocks
Min. surface (width)	3.0 mm	3.4 mm	4.0 mm	9.0 mm
Min. size or effective surface:	10x10 mm (1.0 cm <sup>2</sup> )	15x15 mm (2.25 cm <sup>2</sup> )	15x15 mm (2.25 cm <sup>2</sup> )	15x15 mm (2.25 cm <sup>2</sup> )
Max. size:	400x330 mm			
Min. width of gaps within motifs:	3.0 mm	3.0 mm	3.0 mm	3.0 mm
Edges & angles less than =/< 90° need to be rounded off [diameter]	1.5 mm	2.0 mm	2.7 mm	3.0 mm

### Customization Possibilities for Foil Overlay

Foil overlay min./max. surface (width) outside	min. 3 mm / max. 50 mm			
Foil overlay min./max. in between of crystals surfaces (inside)	min. 3 mm / max. 50 mm			
Foil overlay min. surface	0.3 cm <sup>2</sup> (3x10 mm)	0.45 cm <sup>2</sup> (3x15 mm)	0.45 cm <sup>2</sup> (3x15 mm)	0.45 cm <sup>2</sup> (3x15 mm)
Foil overlay motif outline: edges & angles less than =/< 90° need to be rounded off [diameter]	2.0 mm			

### Ordering Process

Send your request with the drawing you wish to order to your nearest Swarovski sales office. Make sure you include all measurements for the desired motif. Please also indicate which product group your special motif applies to. You will then receive a quotation including your

article number, minimum order quantity, price, and the line drawing of your special motif in PDF format. Please contact your Swarovski sales office again if any changes need to be made. Your special motif will be produced and delivered following your confirmation.

### Please Note

Please always submit the drawing of your desired motif to represent it in the actual size you require. A small sketch, when enlarged to the desired size, will have blurred lines that will make it difficult to correctly reproduce. Pictures or drawings representing 100% size of the design or very good quality scans in JPG, BMP, or DXF format will ensure that we have clear data to work with. These can also be sent via email. If sending a sewing pattern, please include the whole pattern and not just sections. When the sketch is submitted as a copy by email, please include a scale legend (e.g. copy/scan with a ruler next to the drawing). This will ensure that the desired size of the motif can be identified.

It is generally possible to draw motifs with a minimum gap between the outlines. However, due to the tolerance level of the crystals being applied onto carrier film, the final Crystal Textures motifs may differ from the sketches

or prints in relation to the motifs' outline. Therefore the motif, and by extension, the product itself, may be subject to individual variations with each reproduction. These variations are caused by technical production-related factors. As these variations are not deemed to be defects, warranty claims are excluded and Swarovski assumes no liability whatsoever in connection with them.

Special productions are generally offered to all our customers if these are deemed to be feasible and comply with our General Terms and Conditions. Please note that ordering of a design does not grant exclusive production of this design to the customer.

If detailed information on possible tolerances is required (e.g. cavity production for metal parts), please contact your local Swarovski sales office who will enter an application request into our application database.



# Crystaltex Chaton Bandings

Small XILION Chatons turn this product into an exciting, luxurious, and unique statement in the fashion world. Crystaltex Chaton Bandings offer a wide range of design possibilities for the jewelry, fashion accessories, and interior design segments.

## ARTICLE EXPLANATION

**62 030**

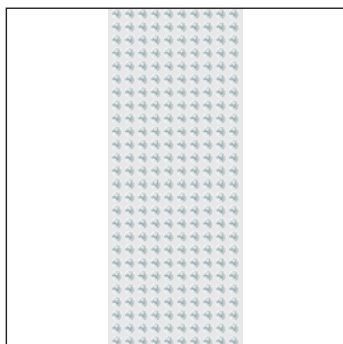

**R** 002-010, 088  
**SS** PP 9 (1028)  
**M** 5 M<sup>1</sup> **100%**

10

62 030	R	SS	M	100 %
Article number	This article is available in 2-10 and 88 rows.	Stone size	Minimum order quantity in meters (M)	% of actual size

## ORDERING EXAMPLE & PRODUCT VARIETY EXPLANATION

62 030	010	S	010	001
Article number	3-digit code for number of rows	Type of base material	Color of base material	Color of crystals
		S Hotfix I It version	010 Transparent 012 Black	Please see the respective product matrix for all available reference codes.

<sup>1</sup> Please note: the 5-meter packing unit can be delivered in batches (max. three parts with a minimum length of 0.5 meters in each batch).

62 030

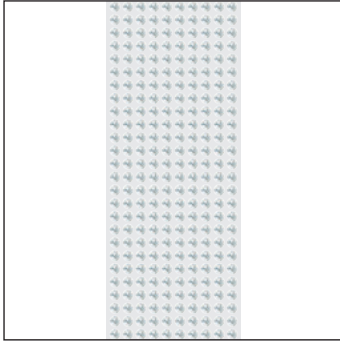

Rows	2 rows	3 rows	4 rows	5 rows	6 rows	7 rows	8 rows	9 rows	10 rows	88 rows	Color of film	010 Transparent (S_Hoflix, L_IT)	012 Black (S_Hoflix, L_IT)
------	--------	--------	--------	--------	--------	--------	--------	--------	---------	---------	---------------	----------------------------------	----------------------------

**Crystal**

Crystal (001)

**Colors**

**Plain Colors**

Black Diamond (215)

Greige (284)

Jet (280)

Light Colorado Topaz (246)

Light Siam (227)

Rose (209)

Silk (391)

Tanzanite (539)

**Crystal Effects**

**Transparent Effects**

Crystal Aurore Boreale (001 AB)

Crystal Golden Shadow (001 GSHA)

Crystal Silver Night (001 SINI)

Crystal Silver Shade (001 SSHA)

**Color Effects**

**Metallic Effects**

Jet Hematite (280 HEM)

Crystal (001)	■	■	■	■	■	■	■	■	■	■	■	■
Black Diamond (215)	■	■	■	■	■	■	■	■	■	■	■	■
Greige (284)	■	■	■	■	■	■	■	■	■	■	■	■
Jet (280)	■	■	■	■	■	■	■	■	■	■	■	■
Light Colorado Topaz (246)	■	■	■	■	■	■	■	■	■	■	■	■
Light Siam (227)	■	■	■	■	■	■	■	■	■	■	■	■
Rose (209)	■	■	■	■	■	■	■	■	■	■	■	■
Silk (391)	■	■	■	■	■	■	■	■	■	■	■	■
Tanzanite (539)	■	■	■	■	■	■	■	■	■	■	■	■
Crystal Aurore Boreale (001 AB)	■	■	■	■	■	■	■	■	■	■	■	■
Crystal Golden Shadow (001 GSHA)	■	■	■	■	■	■	■	■	■	■	■	■
Crystal Silver Night (001 SINI)	■	■	■	■	■	■	■	■	■	■	■	■
Crystal Silver Shade (001 SSHA)	■	■	■	■	■	■	■	■	■	■	■	■
Jet Hematite (280 HEM)	■	■	■	■	■	■	■	■	■	■	■	■

62 031 (Honeycomb)

	3 rows	4 rows	5 rows	6 rows	10 rows	010 Transparent (S_Hoflix, L_IT)	012 Black (S_Hoflix, L_IT)
<b>Crystal</b>							
Crystal (001)	<input type="checkbox"/>	<input type="checkbox"/>	<input type="checkbox"/>	<input type="checkbox"/>	<input type="checkbox"/>	<input type="checkbox"/>	<input type="checkbox"/>
<b>Colors</b>							
<b>Plain Colors</b>							
Black Diamond (215)	<input type="checkbox"/>	<input type="checkbox"/>	<input type="checkbox"/>	<input type="checkbox"/>	<input type="checkbox"/>	<input type="checkbox"/>	<input type="checkbox"/>
Greige (284)	<input type="checkbox"/>	<input type="checkbox"/>	<input type="checkbox"/>	<input type="checkbox"/>	<input type="checkbox"/>	<input type="checkbox"/>	<input type="checkbox"/>
Jet (280)	<input type="checkbox"/>	<input type="checkbox"/>	<input type="checkbox"/>	<input type="checkbox"/>	<input type="checkbox"/>	<input type="checkbox"/>	<input type="checkbox"/>
Light Colorado Topaz (246)	<input type="checkbox"/>	<input type="checkbox"/>	<input type="checkbox"/>	<input type="checkbox"/>	<input type="checkbox"/>	<input type="checkbox"/>	<input type="checkbox"/>
Light Siam (227)	<input type="checkbox"/>	<input type="checkbox"/>	<input type="checkbox"/>	<input type="checkbox"/>	<input type="checkbox"/>	<input type="checkbox"/>	<input type="checkbox"/>
Rose (209)	<input type="checkbox"/>	<input type="checkbox"/>	<input type="checkbox"/>	<input type="checkbox"/>	<input type="checkbox"/>	<input type="checkbox"/>	<input type="checkbox"/>
Silk (391)	<input type="checkbox"/>	<input type="checkbox"/>	<input type="checkbox"/>	<input type="checkbox"/>	<input type="checkbox"/>	<input type="checkbox"/>	<input type="checkbox"/>
Tanzanite (539)	<input type="checkbox"/>	<input type="checkbox"/>	<input type="checkbox"/>	<input type="checkbox"/>	<input type="checkbox"/>	<input type="checkbox"/>	<input type="checkbox"/>
<b>Crystal Effects</b>							
<b>Transparent Effects</b>							
Crystal Aurore Boreale (001 AB)	<input type="checkbox"/>	<input type="checkbox"/>	<input type="checkbox"/>	<input type="checkbox"/>	<input type="checkbox"/>	<input type="checkbox"/>	<input type="checkbox"/>
Crystal Golden Shadow (001 GSHA)	<input type="checkbox"/>	<input type="checkbox"/>	<input type="checkbox"/>	<input type="checkbox"/>	<input type="checkbox"/>	<input type="checkbox"/>	<input type="checkbox"/>
Crystal Silver Night (001 SINI)	<input type="checkbox"/>	<input type="checkbox"/>	<input type="checkbox"/>	<input type="checkbox"/>	<input type="checkbox"/>	<input type="checkbox"/>	<input type="checkbox"/>
Crystal Silver Shade (001 SSHA)	<input type="checkbox"/>	<input type="checkbox"/>	<input type="checkbox"/>	<input type="checkbox"/>	<input type="checkbox"/>	<input type="checkbox"/>	<input type="checkbox"/>
<b>Color Effects</b>							
<b>Metallic Effects</b>							
Jet Hematite (280 HEM)	<input type="checkbox"/>	<input type="checkbox"/>	<input type="checkbox"/>	<input type="checkbox"/>	<input type="checkbox"/>	<input type="checkbox"/>	<input type="checkbox"/>

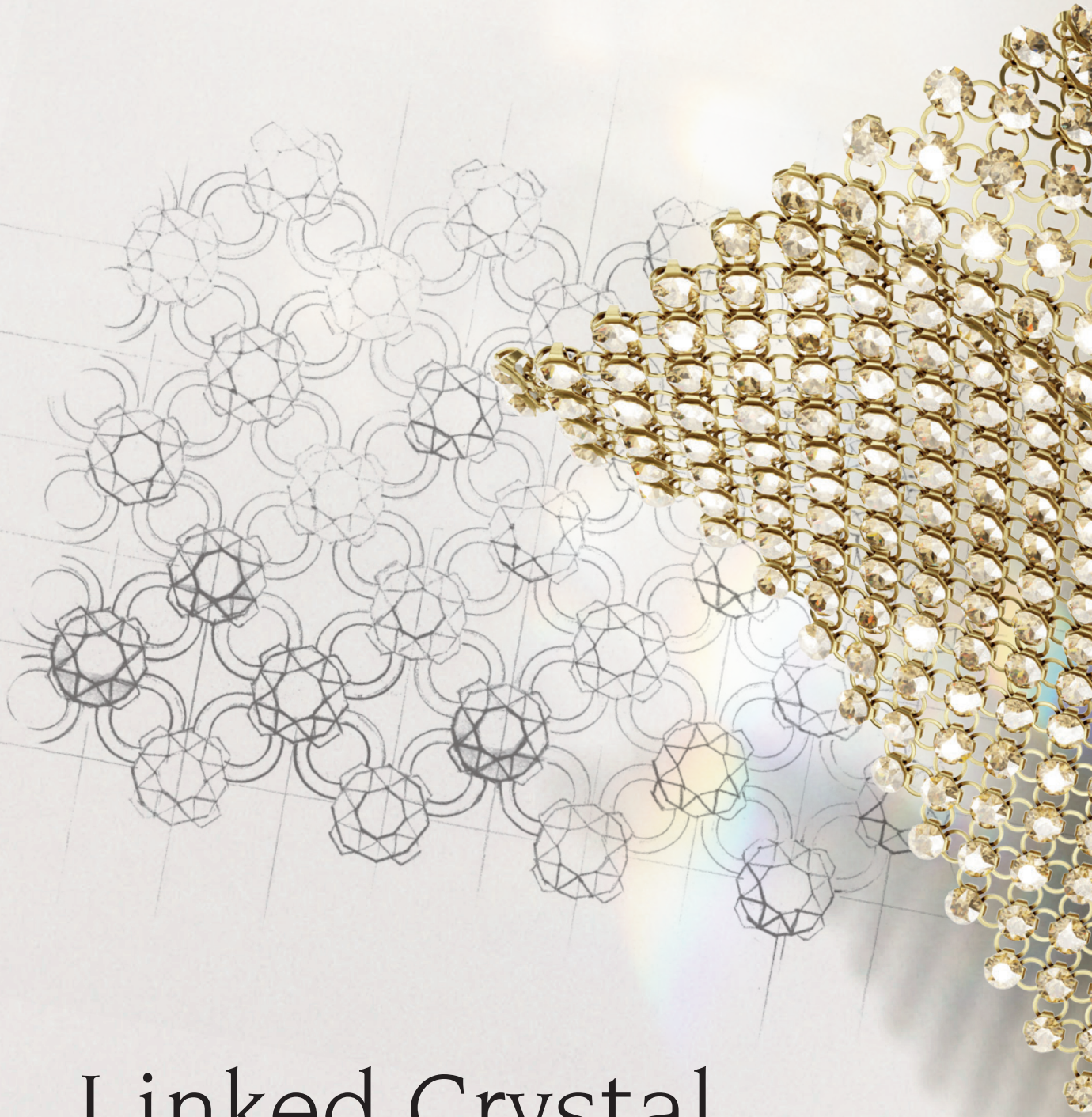

# Linked Crystal Components

Linked Crystal Components are made of loose crystals linked together, either with thread or metal. Divided into three sub-categories: Bandings, Crystal Mesh and Cupchains, they are suitable for use in a wide range of segments, from textiles to accessories.





# Crystal Mesh

Crystal Mesh is a flexible metal mesh carrier with integrated loose crystals. The product is available in a wide range of colors and casings, either as a Hotfix version, which can be applied using heat, or as a No Hotfix version, which can be hand or machine sewn. Crystal Mesh has an extremely smooth and graceful look and feel making it ideal for usage in apparel, accessories, footwear and jewelry.

Choose from single standard colors, standard motifs, or customize designs by incorporating up to nine colors, depending on the mesh type chosen. Crystal Mesh can be ordered in sheets or in rows.

First launched in 1993, Swarovski now presents a distinctive range of six Crystal Mesh variations, providing unparalleled design flexibility to accommodate a wide array of specific creative requirements.

# Crystal Mesh Standard

## ARTICLE EXPLANATION - SHEETS

40 000

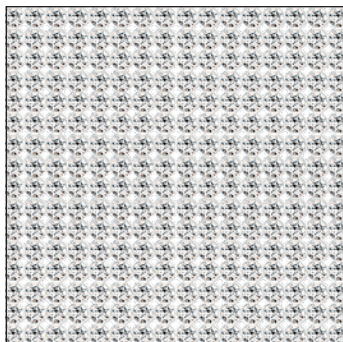

<b>SH</b>	100
<b>S</b>	~500x200
<b>E</b>	1088 PP 21
<b>M</b>	1 SH <b>100%</b>

Crystal Mesh

40 000	SH	S	E	M	100%
Article number	Sheet	Sheet size in mm	Elements Crystals and stone size used	Minimum order quantity in sheets (SH)	% of actual size

## ORDERING EXAMPLE & PRODUCT VARIETY EXPLANATION

40 000	100	082	001	NOHF
Article number	Sheet	Color of casing	Color of crystals	Hotfix Technology
	100 Standard sheet (~500x200 mm)	012 Black <sup>1</sup> 081 Gold <sup>2</sup> 082 Silver <sup>2</sup> 088 Stainless Steel	Please see the respective product matrix for all available reference codes.	NOHF Without Hotfix glue / With Hotfix glue

<sup>1</sup> Base material for 012 Black-colored casing: aluminum

<sup>2</sup> Base material for 081 Gold and 082 Silver-colored casing: brass



## ARTICLE EXPLANATION - ROWS

40 001

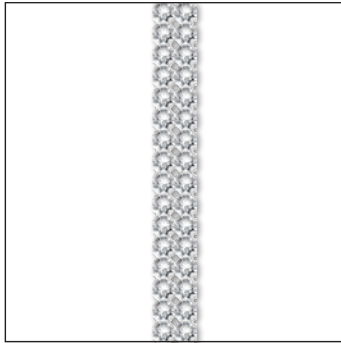
**R** 002-033**E** 1088 PP 21**M** 10 M **100%**

40 001	R	E	M	100%
Article number	Number of rows This article is available from 2 to 33 rows.	Elements Crystal and stone size used	Minimum order quantity in meters (M)	% of actual size

11

## ORDERING EXAMPLE &amp; PRODUCT VARIETY EXPLANATION

40 001	002	082	001	HF
Article number	3-digit code for number of rows	Color of casing 012 Black <sup>1</sup> 081 Gold <sup>2</sup> 082 Silver <sup>2</sup> 088 Stainless Steel	Color of crystals Please see the respective product matrix for all available reference codes.	Hotfix Technology NOHF Without Hotfix glue / With Hotfix glue

<sup>1</sup> Base material for 012 Black-colored casing: aluminum<sup>2</sup> Base material for 081 Gold and 082 Silver-colored casing: brass

**40 000**

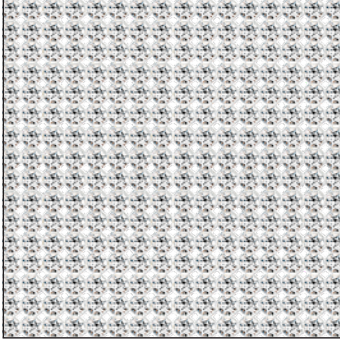

**SH** 100  
**S** ~500x200  
**E** 1088 PP 21  
**M** 1 SH **100%**

**40 001**

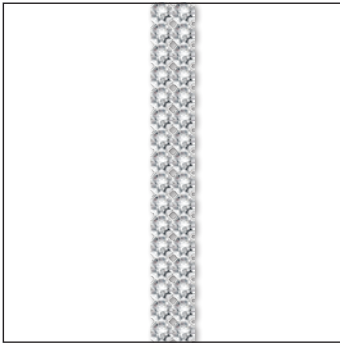

**R** 002-033  
**E** 1088 PP 21  
**M** 10 M **100%**



**Crystal**

Crystal F (001)

**Colors**

**Plain Colors**

Amethyst F (204)

Aquamarine F (202)

Black Diamond F (215)

Chrysolite F (238)

Citrus Green F (337)

Denim Blue F (266)

Emerald F (205)

Golden Topaz F (1003)

Greige F (284)

Iris F (219)

Jet (280)

Light Amber F (1002)

Light Amethyst F (212)

Light Colorado Topaz F (246)

Light Rose F (223)

Light Sapphire F (211)

Light Siam F (227)

Light Topaz F (226)

Light Turquoise F (263)

Montana F (207)

Peridot F (214)

Rose F (209)

Rose Peach F (262)

Sapphire F (206)

Scarlet F (276)

Siam F (208)

Silk F (391)

Smoked Amber F (1001)

Tanzanite F (539)

Vintage Rose F (319)

Violet F (371)

40 000  
40 001

Size  
PP 21

**Opal Colors**

- White Opal F (234)

**Crystal Effects**

**Transparent Effects**

- Crystal AB F (001 AB)
- Crystal Golden Shadow F (001 GSHA)
- Crystal Moonlight F (001 MOL)
- Crystal Silver Night F (001 SINI)
- Crystal Silver Shade F (001 SSHA)

**Color Effects**

**Metallic Effects**

- Jet Hematite F (280 HEM)

**AVAILABLE CASING COLORS**

Crystal Mesh Standard is available with black, gold and silver-colored casings, as well as Stainless Steel casing.



012 Black



081 Gold



082 Silver



088 Stainless Steel

# Crystal Fine Mesh

## ARTICLE EXPLANATION - SHEETS

40 600

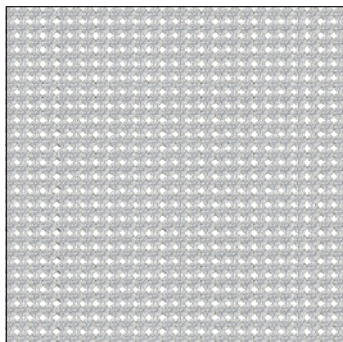

<b>SH</b>	100
<b>S</b>	~500x200
<b>E</b>	1028 PP 9
<b>M</b>	1 SH <b>100%</b>

Crystal Fine Mesh

40 600	SH	S	E	M	100%
Article number	Sheet	Sheet size in mm	Elements Crystals and stone size used	Minimum order quantity in sheets (SH)	% of actual size

## ORDERING EXAMPLE & PRODUCT VARIETY EXPLANATION

40 600	100	082	001	NOHF
Article number	100 Standard Sheet (500x200 mm)	Color of casing 081 Gold <sup>1</sup> 082 Silver <sup>1</sup>	Color of crystals Please see the respective product matrix for all available reference codes.	Hotfix Technology NOHF Without Hotfix glue / With Hotfix glue

<sup>1</sup> Base material for 081 Gold and 082 Silver-colored casing: brass

## ARTICLE EXPLANATION - ROWS

40 601

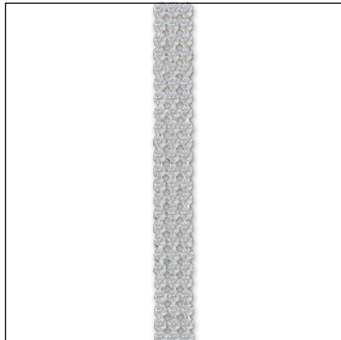

<b>R</b>	003-033	
<b>E</b>	1028 PP 9	
<b>M</b>	10 M	100%

40 601	R	E	M	100%
Article number	Number of rows	Elements Crystals and stone size used	Minimum order quantity in meters (M)	% of actual size

11

## ORDERING EXAMPLE &amp; PRODUCT VARIETY EXPLANATION

40 601	003	082	001	HF
Article number	3-digit code for number of rows	Color of casing 081 Gold <sup>1</sup> 082 Silver <sup>1</sup>	Color of crystals Please see the respective product matrix for all available reference codes.	Hotfix Technology NOHF Without Hotfix glue / With Hotfix glue

<sup>1</sup> Base material for 081 Gold and 082 Silver-colored casing: brass

**40 600**

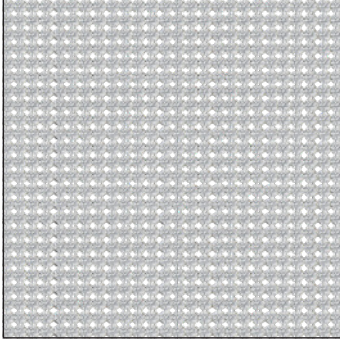

**R** 003-033  
**E** 1028<sup>1</sup> PP 9  
**M** 10 M **100%**

**40 601**

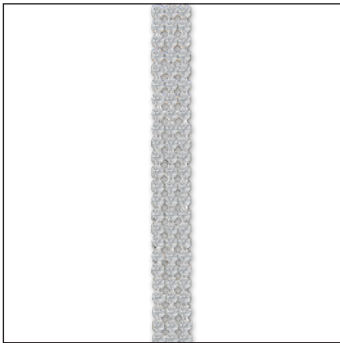

**R** 003-033  
**E** 1028<sup>1</sup> PP 9  
**M** 10 M **100%**

Crystal Fine Mesh



**Crystal**

Crystal F (001)

**Colors**

**Plain Colors**

Amethyst F (204)

Aquamarine F (202)

Black Diamond F (215)

Chrysolite F (238)

Denim Blue F (266)

Emerald F (205)

Golden Topaz F (1003)

Greige F (284)

Iris F (219)

Jet (280)

Light Amber F (1002)

Light Amethyst F (212)

Light Colorado Topaz F (246)

Light Rose F (223)

Light Sapphire F (211)

Light Siam F (227)

Light Topaz F (226)

Light Turquoise F (263)

Montana F (207)

Peridot F (214)

Rose F (209)

Rose Peach F (262)

Sapphire F (206)

Scarlet F (276)

Siam F (208)

Silk F (391)

<sup>1</sup> A different sorting of the 1028 based on tolerances is needed for the production of Fine Mesh. Leadtimes and MOQ will therefore depend on the availability of the sorted item.

**40 600**  
**40 601**

Size

PP 9

- Smoked Amber F (1001)
- Tanzanite F (539)
- Vintage Rose F (319)
- Violet F (371)
- Opal Colors**
- White Opal F (234)
- Crystal Effects**
- Transparent Effects**
- Crystal AB F (001 AB)
- Crystal Golden Shadow F (001 GSHA)
- Crystal Moonlight F (001 MOL)
- Crystal Silver Night F (001 SINI)
- Crystal Silver Shade F (001 SSHA)
- Color Effects**
- Metallic Effects**
- Jet Hematite F (280 HEM)

**AVAILABLE CASING COLORS**

Crystal Fine Mesh is available with gold and silver-colored casing.

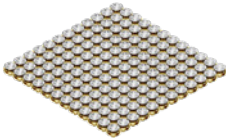

081 Gold



082 Silver

# Crystal Mesh Motifs

## ARTICLE EXPLANATION - SHEETS

55 0707



<b>C</b>	082-280/214/209/206/539/ 211/205/227/204
<b>E</b>	PP9/PP9/PP9/PP9/PP9/PP9/ PP9/PP9
<b>S</b>	~ 150x113
<b>M</b>	3 PCS <b>28%</b>

Crystal Mesh Motifs

55 0707	C	E	S	M	38%
Article number generated by SC Office	Color assortment	Elements  For details, please refer to the sizes overview at the end of the Collection.	Motif size in mm	Minimum order quantity in pieces (PCS)	% of actual size

## ORDERING EXAMPLE & PRODUCT VARIETY EXPLANATION

55 0707	012	276	205	206	HF
Article number generated by SC Office	Color of casing 012 Black <sup>1</sup> 081 Gold <sup>2</sup> 082 Silver <sup>2</sup>	Crystal color corresponding to element 1; color of the most frequently used element in the motif.  Please see the respective product matrix for all available reference codes.	Crystal color corresponding to element 2; color of the second most frequently used element in the motif.	Crystal color corresponding to element 3; color of the third most frequently used element in the motif.	Hotfix Technology  NOHF Without Hotfix glue / With Hotfix glue

<sup>1</sup> Base material for 012 Black-colored casing: aluminum

<sup>2</sup> Base material for 081 Gold and 082 Silver-colored casing: brass  
Casing color 012 is only available for Standard Mesh motif (PP21)



## CRYSTAL MESH INSPIRATIONAL MOTIFS

41 006

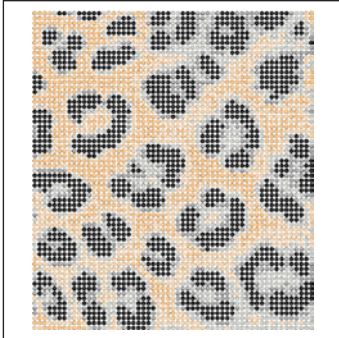

**C** 081-280/246/001SSHA/  
001GSHA/001SINI

**E** PP21/PP21/PP21/PP21/PP21

**S** ~168x192

**M** 2 PCS **22%**

41 007



**C** 082-391/319/223/001/212

**E** PP21/PP21/PP21/PP21/PP21

**S** ~156x17

**M** 33 PCS **27%**

41 009

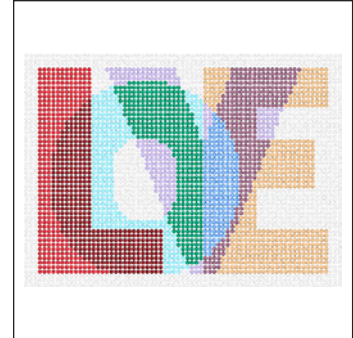

**C** 088-001/001GSHA/208/205/  
227/204/202/539/206

**E** PP21/PP21/PP21/PP21/PP21/  
PP21/PP21/PP21/PP21

**S** ~209x153

**M** 2 PCS **20%**

41 010

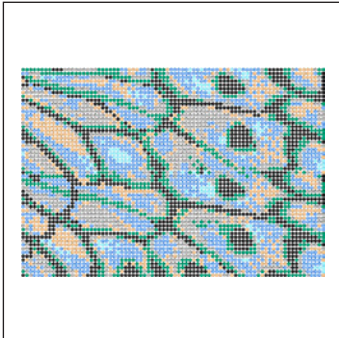

**C** 012-206/215/280/205/  
001GSHA/202

**E** PP21/PP21/PP21/PP21/PP21/PP21

**S** ~236x162

**M** 2 PCS **17%**

41 012

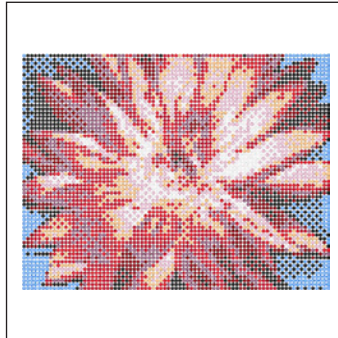

**C** 082-001GSHA/276/212/227/  
208/204/280/206/001

**E** PP21/PP21/PP21/PP21/PP21/  
PP21/PP21/PP21/PP21

**S** ~239x183

**M** 2 PCS **17%**

54 8641

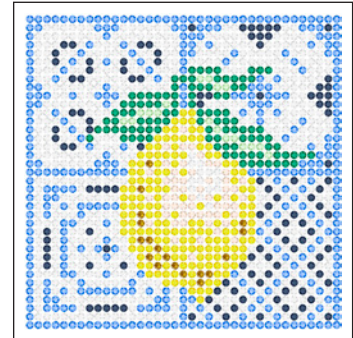

**C** 082-001/206/226/207/205/  
391/1003/214

**E** PP21/PP21/PP21/PP21/PP21/  
PP21/PP21/PP21

**S** ~109x109

**M** 4 PCS **38%**

**FINE MESH INSPIRATIONAL MOTIFS**

**55 0707**



<b>C</b>	082-280/214/209/206/539/ 211/205/227/204
<b>E</b>	PP9/PP9/PP9/PP9/PP9/PP9/ PP9/PP9
<b>S</b>	~ 150x113
<b>M</b>	3 PCS <span style="float: right;"><b>28%</b></span>

**55 0708**

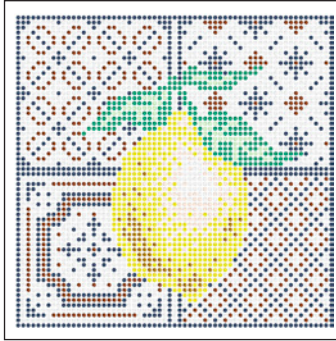

<b>C</b>	082-001/207/1001/226/205/ 391/1003/214
<b>E</b>	PP9/PP9/PP9/PP9/PP9/PP9/ PP9
<b>S</b>	~ 110x108
<b>M</b>	4 PCS <span style="float: right;"><b>38%</b></span>

**55 0709**

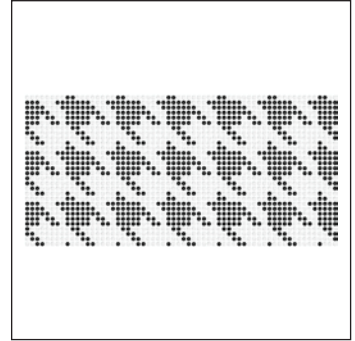

<b>C</b>	082-001/280
<b>E</b>	PP9/PP9
<b>S</b>	~ 108x52
<b>M</b>	12 PCS <span style="float: right;"><b>38%</b></span>

## SPECIAL MOTIF SERVICE

A special motif is a design created by the customer that differs to the Crystal Mesh Standard Collection. This service opens up an abundance of customization possibilities and enables you to profit from Swarovski's long-standing experience and design expertise. A range of customization options for existing motifs is available (see

"Customization Possibilities" below). You can also submit design sketches that meet your special needs, such as a brand image or an image for a particular sales campaign. This will then be made up according to your specifications using Computer Aided Design, which means that adjustments can be made easily according to your needs.

### Customization Possibilities

- Change of size of an existing motif
- Creation of a new motif (ex. Logos, brand names, patterns...)
- Change of size of a mesh sheet / rows (minimum size: 4x4 rows; maximum size: 1x1 m depending on mesh type)
- Up to nine colors are possible per Crystal Mesh Motif
- Motifs are available for Crystal Mesh Standard and Crystal Fine Mesh only

### Ordering Process

Send your request with the drawing you wish to order to your nearest Swarovski sales office.

Make sure you include all measurements for the desired motif. Please also indicate:

- Which product group your special motif applies to (Standard Mesh, Fine Mesh)
- Which casing color you wish to use (081, 082, 012)
- Whether Hotfix should be applied or not

You will then receive a quotation including your article number, minimum order quantity, price, and the line drawing of your special motif in PDF format.

Please contact your Swarovski sales office again if any changes are required. Your special motif will be produced and delivered following your confirmation.

### Please Note

Please always submit the drawing of your desired motif to represent it in the actual size you require. A small sketch, when enlarged to the desired size, will have blurred lines that will make it difficult to correctly reproduce. Pictures or drawings representing 100% size of the design or very good quality scans in JPG, BMP, or DXF format will ensure that we have clear data to work with. These can also be sent via email. If sending a sewing pattern, please include the whole pattern and not just sections. When the sketch is submitted as a copy by email, please include a scale

legend (e.g. copy/scan with a ruler next to the drawing). This will ensure that the desired size of the motif can be identified.

Special productions are generally offered to all our customers if these are deemed to be feasible and comply with our General Terms and Conditions. Please note ordering of a design does not grant exclusive production of this design to the customer.

# Crystal Light Mesh & Crystal Light Mesh Mini

## ARTICLE EXPLANATION - SHEETS

**40 900** Crystal Light Mesh

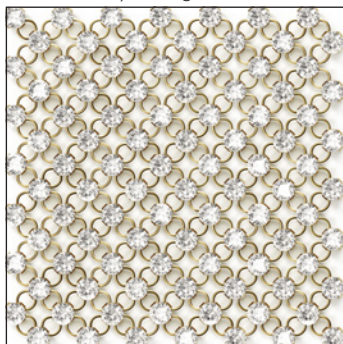

<b>SH</b>	100
<b>S</b>	~500x200
<b>E</b>	1088 PP21
<b>M</b>	1 SH <b>100%</b>

**40 910** Crystal Light Mesh Mini

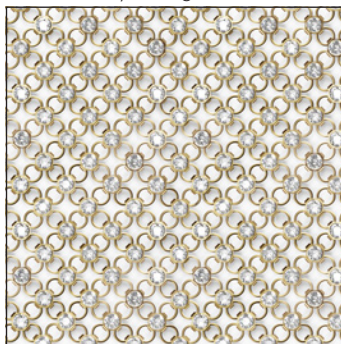

<b>SH</b>	100
<b>S</b>	~500x200
<b>E</b>	1088 PP14
<b>M</b>	1 SH <b>100%</b>

Crystal Light Mesh & Crystal Light Mesh Mini

40 900 40 910	SH	S	E	M	100%
Article number	Sheet	Sheet size in mm	Elements Crystals and stone size used	Minimum order quantity in sheets (SH)	% of actual size

## ORDERING EXAMPLE & PRODUCT VARIETY EXPLANATION

40 900 40 910	100	081	001	NOHF
Article number	Sheet	Color of casing	Color of crystals	Hotfix Technology
	100 Standard sheet (~500x200 mm)	081 Gold <sup>1</sup> 082 Silver <sup>1</sup>	Please see the relevant product matrix for all available reference codes.	NOHF Without Hotfix glue / With Hotfix glue

<sup>1</sup> Base material for 081 Gold and 082 Silver-colored casing: brass

**ARTICLE EXPLANATION - ROWS**

**40 901** Crystal Light Mesh



<b>R</b>	003-010
<b>E</b>	1088 PP21
<b>M</b>	10 M <b>100%</b>

**40 911** Crystal Light Mesh Mini

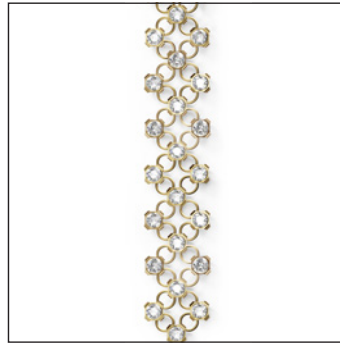

<b>R</b>	003-010
<b>E</b>	1088 PP14
<b>M</b>	10 M <b>100%</b>

40 901 40 911	R	E	M	100%
Article number	Number of rows	Elements	Minimum order quantity in meters (M)	% of actual size
	This article is available from 3 to 10 rows.	Crystals and stone size used		

11

**ORDERING EXAMPLE & PRODUCT VARIETY EXPLANATION**

40 901 40 911	003	081	001	NOHF
Article number	3-digit code for number of rows	Color of casing	Color of crystals	Hotfix Technology
		081 Gold <sup>1</sup> 082 Silver <sup>1</sup>	Please see the relevant product matrix for all available reference codes.	NOHF Without Hotfix glue / With Hotfix glue

<sup>1</sup> Base material for 081 Gold and 082 Silver-colored casing: brass

**40 900** Crystal Light Mesh

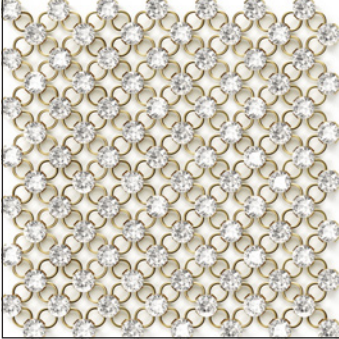

**SH** 100  
**S** ~500x200  
**E** 1088 PP21  
**M** 1 SH **100%**

**40 901** Crystal Light Mesh



**R** 003-010  
**E** 1088 PP21  
**M** 10 M **100%**

Crystal Light Mesh & Crystal Light Mesh Mini

**40 910** Crystal Light Mesh Mini

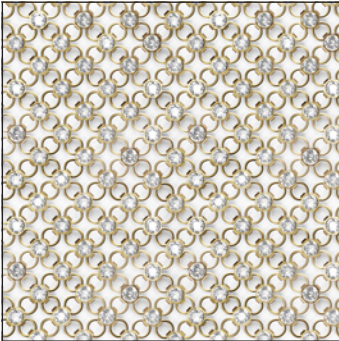

**SH** 100  
**S** ~500x200  
**E** 1088 PP14  
**M** 1 SH **100%**

**40 911** Crystal Light Mesh Mini

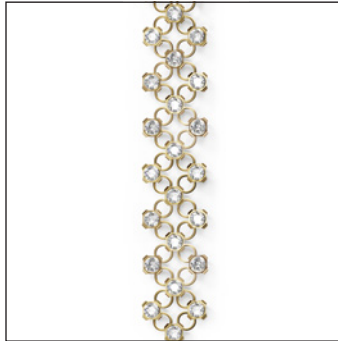

**R** 003-010  
**E** 1088 PP14  
**M** 10 M **100%**

**40 900/40 901**  
**40 910/40 911**

	<b>Size</b>	<b>40 900/40 901</b> Crystal Light Mesh	PP 21	<b>40 910/40 911</b> Crystal Light Mesh Mini	PP 14
<b>Crystal</b>					
Crystal F (001)					
<b>Colors</b>					
<b>Plain Colors</b>					
Amethyst F (204)					
Aquamarine F (202)					
Black Diamond F (215)					
Chrysolite F (238)					
Citrus Green F (337)					
Denim Blue F (266)					
Emerald F (205)					
Golden Topaz F (1003)					
Greige F (284)					
Iris F (219)					
Jet (280)					
Light Amber F (1002)					
Light Amethyst F (212)					
Light Colorado Topaz F (246)					
Light Rose F (223)					
Light Sapphire F (211)					
Light Siam F (227)					
Light Topaz F (226)					
Light Turquoise F (263)					
Montana F (207)					

**40 900/40 901**  
**40 910/40 911**

	<b>Size</b>	<b>40 900/40 901</b> Crystal Light Mesh	PP 21	<b>40 910/40 911</b> Crystal Light Mesh Mini	PP 14
Peridot F (214)					
Rose F (209)					
Rose Peach F (262)					
Sapphire F (206)					
Scarlet F (276)					
Siam F (208)					
Silk F (391)					
Smoked Amber F (1001)					
Tanzanite F (539)					
Vintage Rose F (319)					
Violet F (371)					
<b>Opal Colors</b>					
White Opal F (234)					
<b>Crystal Effects</b>					
<b>Transparent Effects</b>					
Crystal AB F (001 AB)					
Crystal Golden Shadow F (001 GSHA)					
Crystal Moonlight F (001 MOL)					
Crystal Silver Night F (001 SINI)					
Crystal Silver Shade F (001 SSHA)					
<b>Color Effects</b>					
<b>Metallic Effects</b>					
Jet Hematite F (280 HEM)					

11

**AVAILABLE CASING COLORS**

Crystal Light Mesh and Light Mesh Mini are available with gold and silver-colored casings.



081 Gold

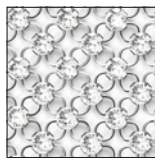

082 Silver

# Crystal Mesh Colorée & Crystal Mesh Colorée Mini

## ARTICLE EXPLANATION - SHEETS

**40 200** Crystal Mesh Colorée

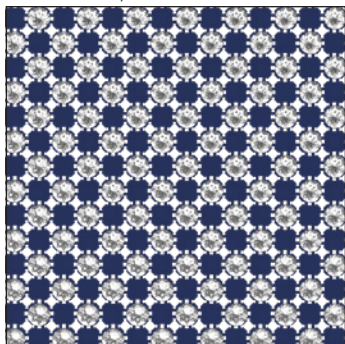

<b>SH</b>	100
<b>S</b>	~500x200
<b>E</b>	1088 PP 21
<b>M</b>	1 SH <b>100%</b>

**40 210** Crystal Mesh Colorée Mini

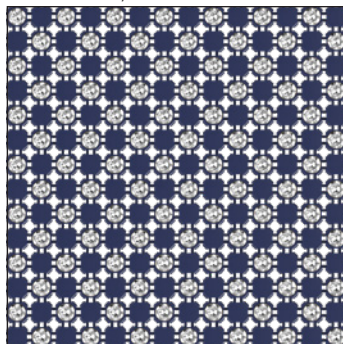

<b>SH</b>	100
<b>S</b>	~500x200
<b>E</b>	1088 PP14
<b>M</b>	1 SH <b>100%</b>

Crystal Mesh Colorée & Crystal Mesh Colorée Mini

40 200 40 210	SH	S	E	M	100%
Article number	Sheet	Sheet size in mm	Elements Crystals and stone size used	Minimum order quantity in sheets (SH)	% of actual size

## ORDERING EXAMPLE & PRODUCT VARIETY EXPLANATION

40 200 40 210	100	082	001	NOHF
Article number	Sheet	Color of casing	Color of crystals	Hotfix Technology
	100 Standard sheet (-500x200 mm)	081 Gold <sup>1</sup> 082 Silver <sup>1</sup> R9005 Jet Black <sup>2</sup> R5022 Night Blue <sup>2</sup> R1015 Light Ivory <sup>2</sup>	Please see the relevant product matrix for all available reference codes.	NOHF Without Hotfix glue / With Hotfix glue

<sup>1</sup> Base material for 081 Gold and 082 Silver-colored casing: brass

<sup>2</sup> Base material for RAL colors: aluminium



## ARTICLE EXPLANATION - ROWS

40 201 Crystal Mesh Colorée

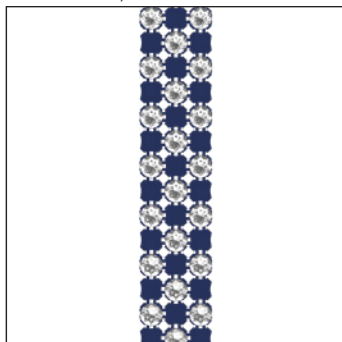

<b>R</b>	003-010	
<b>E</b>	1088 PP 21	
<b>M</b>	10 M	100%

40 211 Crystal Mesh Colorée Mini

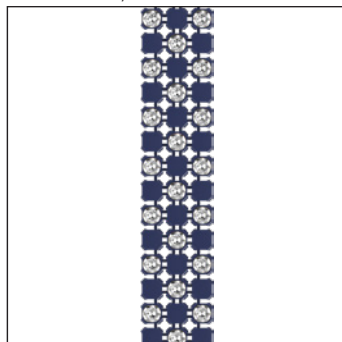

<b>R</b>	003-010	
<b>E</b>	1088 PP14	
<b>M</b>	10 M	100%

40 201 40 211	R	E	M	100%
Article number	Number of rows	Elements	Minimum order quantity in meters (M)	% of actual size
	This article is available from 3 to 10 rows.	Crystals and stone size used		

11

## ORDERING EXAMPLE &amp; PRODUCT VARIETY EXPLANATION

40 201 40 211	003	082	001	NOHF
Article number	3-digit code for number of rows	Color of casing	Color of crystals	Hotfix Technology
		081 Gold <sup>1</sup> 082 Silver <sup>1</sup> R9005 Jet Black <sup>2</sup> R5022 Night Blue <sup>2</sup> R1015 Light Ivory <sup>2</sup>	Please see the relevant product matrix for all available reference codes.	NOHF Without Hotfix glue / With Hotfix glue

<sup>1</sup> Base material for 081 Gold and 082 Silver-colored casing: brass

<sup>2</sup> Base material for RAL colors: aluminium

**40 200**

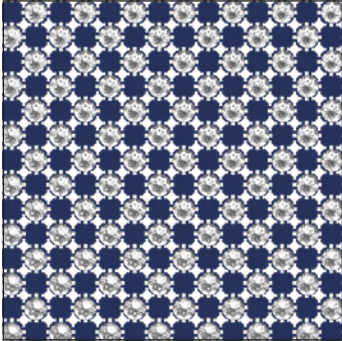

**SH** 100  
**S** ~500x200  
**E** 1088 PP 21  
**M** 1 SH **100%**

**40 201**



**R** 003-010  
**E** 1088 PP 21  
**M** 10 M **100%**

**40 210** Crystal Mesh Colorée Mini

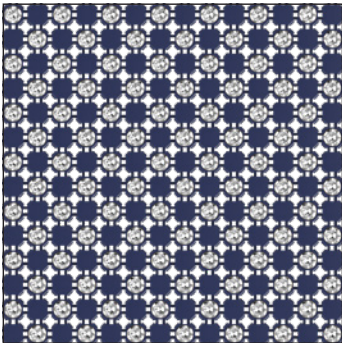

**SH** 100  
**S** ~500x200  
**E** 1088 PP14  
**M** 1 SH **100%**

**40 211** Crystal Mesh Colorée Mini

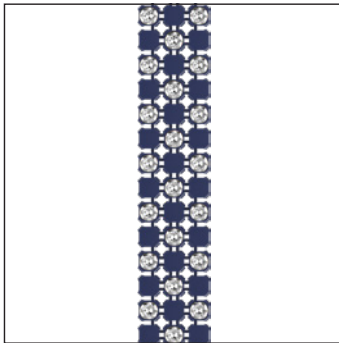

**R** 003-010  
**E** 1088 PP14  
**M** 10 M **100%**

**40 200/40 201**  
**40 210/40 211**

Size	40 200/40 201 Crystal Mesh Colorée	40 210/40 211 Crystal Mesh Colorée Mini
	PP 21	PP 14
<b>Crystal</b>		
<input type="checkbox"/> Crystal F (001)	<input type="checkbox"/>	<input type="checkbox"/>
<b>Colors</b>		
<b>Plain Colors</b>		
<input type="checkbox"/> Amethyst F (204)	<input type="checkbox"/>	<input type="checkbox"/>
<input type="checkbox"/> Aquamarine F (202)	<input type="checkbox"/>	<input type="checkbox"/>
<input type="checkbox"/> Black Diamond F (215)	<input type="checkbox"/>	<input type="checkbox"/>
<input type="checkbox"/> Chrysolite F (238)	<input type="checkbox"/>	<input type="checkbox"/>
<input type="checkbox"/> Citrus Green F (337)	<input type="checkbox"/>	<input type="checkbox"/>
<input type="checkbox"/> Denim Blue F (266)	<input type="checkbox"/>	<input type="checkbox"/>
<input type="checkbox"/> Emerald F (205)	<input type="checkbox"/>	<input type="checkbox"/>
<input type="checkbox"/> Golden Topaz F (1003)	<input type="checkbox"/>	<input type="checkbox"/>
<input type="checkbox"/> Greige F (284)	<input type="checkbox"/>	<input type="checkbox"/>
<input type="checkbox"/> Iris F (219)	<input type="checkbox"/>	<input type="checkbox"/>
<input type="checkbox"/> Jet (280)	<input type="checkbox"/>	<input type="checkbox"/>
<input type="checkbox"/> Light Amber F (1002)	<input type="checkbox"/>	<input type="checkbox"/>
<input type="checkbox"/> Light Amethyst F (212)	<input type="checkbox"/>	<input type="checkbox"/>
<input type="checkbox"/> Light Colorado Topaz F (246)	<input type="checkbox"/>	<input type="checkbox"/>
<input type="checkbox"/> Light Rose F (223)	<input type="checkbox"/>	<input type="checkbox"/>
<input type="checkbox"/> Light Sapphire F (211)	<input type="checkbox"/>	<input type="checkbox"/>
<input type="checkbox"/> Light Siam F (227)	<input type="checkbox"/>	<input type="checkbox"/>
<input type="checkbox"/> Light Topaz F (226)	<input type="checkbox"/>	<input type="checkbox"/>
<input type="checkbox"/> Light Turquoise F (263)	<input type="checkbox"/>	<input type="checkbox"/>
<input type="checkbox"/> Montana F (207)	<input type="checkbox"/>	<input type="checkbox"/>

**40 200/40 201**  
**40 210/40 211**

Size	40 200/40 201 Crystal Mesh Colorée	40 210/40 211 Crystal Mesh Colorée Mini
	PP 21	PP 14
<input type="checkbox"/> Peridot F (214)	<input type="checkbox"/>	<input type="checkbox"/>
<input type="checkbox"/> Rose F (209)	<input type="checkbox"/>	<input type="checkbox"/>
<input type="checkbox"/> Rose Peach F (262)	<input type="checkbox"/>	<input type="checkbox"/>
<input type="checkbox"/> Sapphire F (206)	<input type="checkbox"/>	<input type="checkbox"/>
<input type="checkbox"/> Scarlet F (276)	<input type="checkbox"/>	<input type="checkbox"/>
<input type="checkbox"/> Siam F (208)	<input type="checkbox"/>	<input type="checkbox"/>
<input type="checkbox"/> Silk F (391)	<input type="checkbox"/>	<input type="checkbox"/>
<input type="checkbox"/> Smoked Amber F (1001)	<input type="checkbox"/>	<input type="checkbox"/>
<input type="checkbox"/> Tanzanite F (539)	<input type="checkbox"/>	<input type="checkbox"/>
<input type="checkbox"/> Vintage Rose F (319)	<input type="checkbox"/>	<input type="checkbox"/>
<input type="checkbox"/> Violet F (371)	<input type="checkbox"/>	<input type="checkbox"/>
<b>Opal Colors</b>		
<input type="checkbox"/> White Opal F (234)	<input type="checkbox"/>	<input type="checkbox"/>
<b>Crystal Effects</b>		
<b>Transparent Effects</b>		
<input type="checkbox"/> Crystal AB F (001 AB)	<input type="checkbox"/>	<input type="checkbox"/>
<input type="checkbox"/> Crystal Golden Shadow F (001 GSHA)	<input type="checkbox"/>	<input type="checkbox"/>
<input type="checkbox"/> Crystal Moonlight F (001 MOL)	<input type="checkbox"/>	<input type="checkbox"/>
<input type="checkbox"/> Crystal Silver Night F (001 SINI)	<input type="checkbox"/>	<input type="checkbox"/>
<input type="checkbox"/> Crystal Silver Shade F (001 SSHA)	<input type="checkbox"/>	<input type="checkbox"/>
<b>Color Effects</b>		
<b>Metallic Effects</b>		
<input type="checkbox"/> Jet Hematite F (280 HEM)	<input type="checkbox"/>	<input type="checkbox"/>

### AVAILABLE CASING COLORS

Crystal Mesh Colorée and Crystal Mesh Colorée Mini is available as standard with gold and silver-colored casings as well as the RAL colors Jet Black (RAL 9005), Night Blue (RAL 5022) and Light Ivory (RAL 1015).

All further RAL Classic and RAL Design Colors are possible as customized solution.



081 Gold



082 Silver



R9005 Jet Black

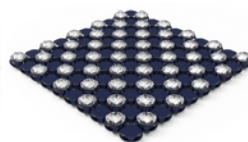

R5022 Night Blue

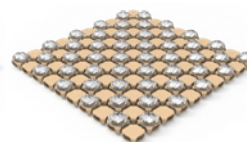

R1015 Light Ivory

## PRODUCT DETAILS

Article Variant	Packing Unit = Minimum Order Quantity	Number of Rows	Number of Crystals
<b>40 000</b>			
Sheet	~500x200 mm	170x66 rows	11,220
Row	Length: 10 m	2-33 rows	~3,400/row/10 m
<b>40 600</b>			
Sheet	~500x200 mm	286x110 rows	31,460
Row	Length: 10 m	3-33 rows	~5,720/row/10 m
<b>40 200 &amp; 40 210</b>			
Sheet	~500x200 mm	170x66 rows	5,610
Row	Length: 10 m	3-10 rows	~1,700/row/10 m
<b>40 900 &amp; 40 910</b>			
Sheet	~500x200 mm	170x66 rows	5,610
Row	Length: 10 m	3-10 rows	~1,700/row/10 m

Article Casing Color	Weight for 1 sheet NOHF (g)*
<b>40 000</b>	
012	240
081, 082	395
088	365
<b>40 600</b>	
081, 082	255
<b>40 200</b>	
081, 082	310
RAL	160
<b>40 210</b>	
081, 082	262
RAL	112
<b>40 900</b>	
081, 082	200
<b>40 910</b>	
081, 082	170

\* Applying HF (Hotfix) to a sheet adds about 10 g to the overall sheet weight.



# Cupchains

Incorporating a Round Stone, Cupchains have a metal chain base, and are offered in a large variety of colors and sizes. They can be soldered, plated, and sewn by hand or machine.

# Round Cupchains

## ARTICLE EXPLANATION - BASE ITEM NUMBER

**27 004** Round Cupchain



Round Cupchains

2	7	0	04
Product category	Stone code (type of stone used)	Setting code	Number of prongs in the setting (always 2-digit code)
2 Cupchains	7 Round	0 Basic 1 Extended	04

Not all configurations are available for all articles. Please refer to the respective product matrix for available combinations.



## ORDERING EXAMPLE &amp; PRODUCT VARIETY EXPLANATION

<b>1</b>	<b>27 004</b>	<b>P24</b>	<b>00</b>	<b>C</b>
Material type	Base item number	Stone size	Ring configuration	Back configuration
1 Brass		3-digit code from respective product matrix	00 None	C Closed

<b>C1</b>	<b>Z</b>	<b>1028</b>	<b>F</b>	<b>001</b>
Stone pattern	Plating	Base item art. no.	Foiling	Color of crystals
A1 Crystal with effect C1 Color K1 Crystal F2 2 alternate colors F3 3 alternate colors F4 4 alternate colors F5 5 alternate colors F6 6 alternate colors	Z No Plating H Rhodium	1028 1088	F Foiled	

**27 004** Round (Z)



E 1028/1088  
M 20 M **250%<sup>1</sup>**

**Available Stone Sizes:**

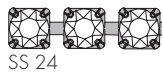
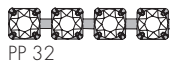
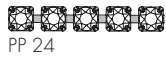
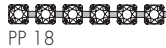

Round Cupchains

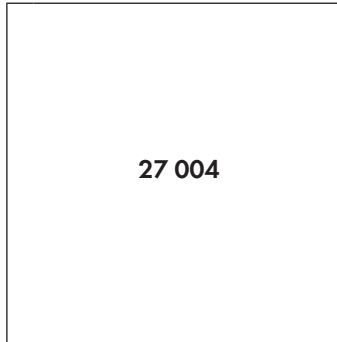

Size	PP 11	PP 14	PP 18	PP 24	PP 32	SS 24
------	-------	-------	-------	-------	-------	-------

**Crystal**

Crystal F (001)

**Colors**

**Plain Colors**

Amethyst F (204)

Aquamarine F (202)

Black Diamond F (215)

Chrysolite F (238)

Citrus Green F (337)

Denim Blue F (266)

Emerald F (205)

Golden Topaz F (1003)

Greige F (284)

Iris F (219)

Jet (280)

Light Amber F (1002)

Light Amethyst F (212)

Light Colorado Topaz F (246)

Light Rose F (223)

Light Sapphire F (211)

Light Siam F (227)

Light Topaz F (226)

Light Turquoise F (263)

Montana F (207)

Peridot F (214)

Rose F (209)

Rose Peach F (262)

Sapphire F (206)

Scarlet F (276)

Siam F (208)

Silk F (391)

Smoked Amber F (1001)

The plating resistance of effects should be considered and can be verified using the respective product information sheet.

<sup>1</sup> The picture shows size PP 32

27 004	Size					
	PP 11	PP 14	PP 18	PP 24	PP 32	SS 24
Tanzanite F (539)	■	■	■	■	■	■
Vintage Rose F (319)	■	■	■	■	■	■
Violet F (371)	■	■	■	■	■	■
<b>Opal Colors</b>						
White Opal F (234)	■	■	■	■	■	■
<b>Crystal Effects</b>						
<b>Transparent Effects</b>						
Crystal Aurore Boreale F (001 AB)	■	■	■	■	■	■
Crystal Golden Shadow F (001 GSHA)	■	■	■	■	■	■
Crystal Moonlight F (001 MOL)	■	■	■	■	■	■
Crystal Silver Night F (001 SINI)	■	■	■	■	■	■
Crystal Silver Shade F (001 SSHA)	■	■	■	■	■	■

**AVAILABLE PLATING COLORS**

Standard cupchains are available in brass (unplated). The customer can use these cupchains for soldering, before plating them on their own.



Brass (Z) front

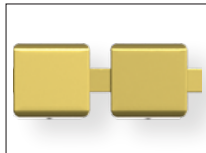

Brass (Z) back

The following color is available as customized solution:



Rhodium (H) front



Rhodium (H) back

# Round Extended Cupchains

## ARTICLE EXPLANATION - BASE ITEM NUMBER

**27 104** Round Extended (Z)

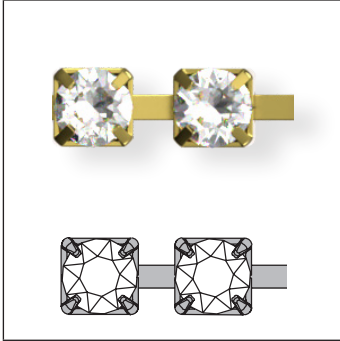

Round Extended Cupchains

2	7	1	04
Product category	Stone code (type of stone used)	Setting code	Number of prongs in the setting (always 2-digit code)
2 Cupchains	7 Round	0 Basic 1 Extended	04

Not all configurations are available for all articles. Please refer to the respective product matrix for available combinations.

## ORDERING EXAMPLE &amp; PRODUCT VARIETY EXPLANATION

<b>1</b>	<b>27 104</b>	<b>P24</b>	<b>00</b>	<b>C</b>
Material type	Base item number	Stone size	Ring configuration	Back configuration
1 Brass		3-digit code from respective product matrix	00 None	C Closed
<b>C1</b>	<b>Z</b>	<b>1088</b>	<b>F</b>	<b>001</b>
Stone pattern	Plating	Base item art. no.	Foiling	Color of crystals
A1 Crystal with effect C1 Color K1 Crystal F2 2 alternate colors F3 3 alternate colors F4 4 alternate colors F5 5 alternate colors F6 6 alternate colors	Z No Plating H Rhodium	1088	F Foiled	

**27 104** Round Extended (Z)

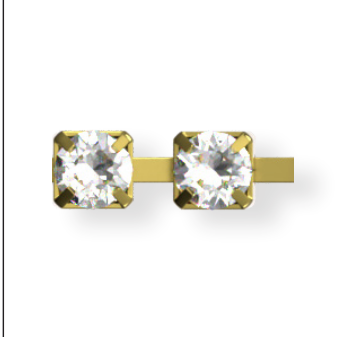

E 1088  
M 20 M 250%<sup>1</sup>

**Available Stone Sizes:**

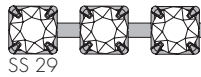
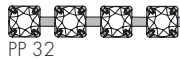
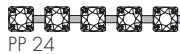

Round Extended Cupchains

The plating resistance of effects should be considered and can be verified using the respective product information sheet.

<sup>1</sup> The picture shows size PP 22

Crystal	Size			
	PP 14	PP 24	PP 32	SS 29
Crystal F (001)	■	■	■	■
<b>Colors</b>				
<b>Plain Colors</b>				
Amethyst F (204)	■	■	■	■
Aquamarine F (202)	■	■	■	■
Black Diamond F (215)	■	■	■	■
Chrysolite F (238)	■	■	■	■
Citrus Green F (337)	■	■	■	■
Denim Blue F (266)	■	■	■	■
Emerald F (205)	■	■	■	■
Golden Topaz F (1003)	■	■	■	■
Greige F (284)	■	■	■	■
Iris F (219)	■	■	■	■
Jet (280)	■	■	■	■
Light Amber F (1002)	■	■	■	■
Light Amethyst F (212)	■	■	■	■
Light Colorado Topaz F (246)	■	■	■	■
Light Rose F (223)	■	■	■	■
Light Sapphire F (211)	■	■	■	■
Light Siam F (227)	■	■	■	■
Light Topaz F (226)	■	■	■	■
Light Turquoise F (263)	■	■	■	■
Montana F (207)	■	■	■	■
Peridot F (214)	■	■	■	■
Rose F (209)	■	■	■	■
Rose Peach F (262)	■	■	■	■
Sapphire F (206)	■	■	■	■
Scarlet F (276)	■	■	■	■
Siam F (208)	■	■	■	■
Silk F (391)	■	■	■	■
Smoked Amber F (1001)	■	■	■	■
Tanzanite F (539)	■	■	■	■
Vintage Rose F (319)	■	■	■	■
Violet F (371)	■	■	■	■

## 27 104

Size	PP 14	PP 24	PP 32	SS 29
<b>Opal Colors</b>				
White Opal F (234)	■	■	■	■
<b>Crystal Effects</b>				
<b>Transparent Effects</b>				
Crystal Aurore Boreale F (001 AB)	■	■	■	■
Crystal Golden Shadow F (001 GSHA)	■	■	■	■
Crystal Moonlight F (001 MOL)	■	■	■	■
Crystal Ignite (001 IGNIT)				■
Crystal Silver Night F (001 SINI)	■	■	■	■
Crystal Silver Shade F (001 SSHA)	■	■	■	■
<b>Crystal Lacquer<sup>PRO</sup> Effects</b>				
<b>Crystal Lacquer<sup>PRO</sup> Ignite Effects</b>				
Crystal Flamingo Ignite (001 L162I)				■
Crystal Linen Ignite (001 L164I)				■
Crystal Maroon Ignite (001 L160I)				■
Crystal Orange Ignite (001 L159I)				■
Crystal Purple Ignite (001 L161I)				■
Crystal Sky Ignite (001 L163I)				■
<b>Crystal Lacquer<sup>PRO</sup> DeLite Effects</b>				
Crystal Dusty Pink DeLite (001 L149D)				■
Crystal Ivory Cream DeLite (001 L106D)				■
Crystal Laguna DeLite (001 L142D)				■
Crystal Lavender DeLite (001 L144D)				■
Crystal Lotus Pink DeLite (001 L145D)				■
Crystal Ocean DeLite (001 L143D)				■
Crystal Orange Glow DeLite (001 L146D)				■
Crystal Royal Blue DeLite (001 L110D)				■
Crystal Royal Red DeLite (001 L107D)				■
Crystal Serene Gray DeLite (001 L150D)				■
Crystal Silky Sage DeLite (001 L147D)				■

## 27 104

Size	PP 14	PP 24	PP 32	SS 29
<b>Color Effects</b>				
<b>Transparent Effects</b>				
Amethyst Ignite (204 IGNIT)				■
Aquamarine Ignite (204 IGNIT)				■
Emerald Ignite (205 IGNIT)				■
Light Colorado Topaz Ignite (246 IGNIT)				■
Light Rose Ignite (223 IGNIT)				■
Scarlet Ignite (276 IGNIT)				■

### AVAILABLE PLATING COLORS

Standard cupchains are available in brass (unplated). The customer can use these cupchains for soldering, before plating them on their own.

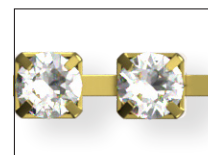

Brass (Z) front

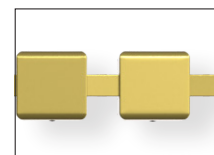

Brass (Z) back

The following color is available as customized solution:

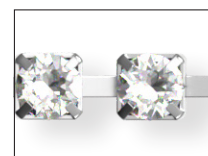

Rhodium (H) front

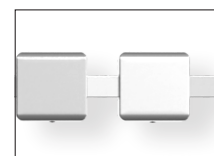

Rhodium (H) back

# Bezel Chains

## ARTICLE EXPLANATION - BASE ITEM NUMBER

**27 000** Bezel Chain



2	7	0	00
Product category	Stone code (type of stone used)	Setting code	Number of prongs in the setting (always 2-digit code)
2 Cupchains	7 Round	0 Basic	00

Bezel Cupchains



## ORDERING EXAMPLE &amp; PRODUCT VARIETY EXPLANATION

<b>1</b>	<b>27 000</b>	<b>P18</b>	<b>00</b>	<b>C</b>
Material type	Base item number	Stone size	Ring configuration	Back configuration
1 Brass		3-digit code from respective product matrix	00 None	C Closed
<b>C1</b>	<b>Z</b>	<b>1088</b>	<b>F</b>	<b>001</b>
Stone pattern	Plating	Base item art. no.	Foiling	Color of crystals
A1 Crystal with effect C1 Color K1 Crystal F2 2 alternate colors F3 3 alternate colors	Z No Plating H Rhodium	1088	F Foiled	

**27 000** Bezel Chain (Z)

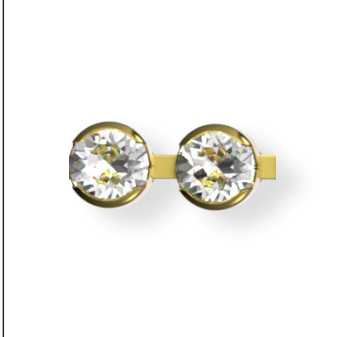

E 1088  
M 20 M 250%<sup>1</sup>

**Available Stone Sizes:**

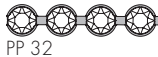
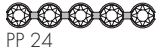

Bezel Cupchains

Crystal	Size	PP 24	PP 32	SS 24
Crystal F (001)		■	■	■
Colors				
Plain Colors				
Amethyst F (204)		■	■	■
Aquamarine F (202)		■	■	■
Black Diamond F (215)		■	■	■
Chrysolite F (238)		■	■	■
Citrus Green F (337)		■	■	■
Denim Blue F (266)		■	■	■
Emerald F (205)		■	■	■
Golden Topaz F (1003)		■	■	■
Greige F (284)		■	■	■
Iris F (219)		■	■	■
Jet (280)		■	■	■
Light Amber F (1002)		■	■	■
Light Amethyst F (212)		■	■	■
Light Colorado Topaz F (246)		■	■	■
Light Rose F (223)		■	■	■
Light Sapphire F (211)		■	■	■
Light Siam F (227)		■	■	■
Light Topaz F (226)		■	■	■
Light Turquoise F (263)		■	■	■
Montana F (207)		■	■	■
Peridot F (214)		■	■	■
Rose F (209)		■	■	■
Rose Peach F (262)		■	■	■
Sapphire F (206)		■	■	■
Scarlet F (276)		■	■	■
Siam F (208)		■	■	■
Silk F (391)		■	■	■
Smoked Amber F (1001)		■	■	■

The plating resistance of effects should be considered and can be verified using the respective product information sheet.

<sup>1</sup> The picture shows size PP 32

<b>27 000</b>	<b>Size</b>	PP 24	PP 32	SS 24
	Tanzanite F (539)	■	■	■
	Vintage Rose F (319)	■	■	■
	Violet F (371)	■	■	■
<b>Opal Colors</b>				
	White Opal F (234)	■	■	■
<b>Crystal Effects</b>				
<b>Transparent Effects</b>				
	Crystal Aurore Boreale F (001 AB)	■	■	■
	Crystal Golden Shadow F (001 GSHA)	■	■	■
	Crystal Moonlight F (001 MOL)	■	■	■
	Crystal Silver Night F (001 SINI)	■	■	■
	Crystal Silver Shade F (001 SSHA)	■	■	■

**AVAILABLE PLATING COLORS**

Bezel Chains are available in brass (unplated). The customer can use these cupchains for soldering, before plating them on their own.



Brass (Z) front

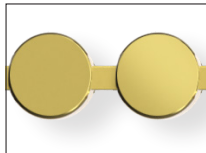

Brass (Z) back

The following color is available as customized solution:



Rhodium (H) front

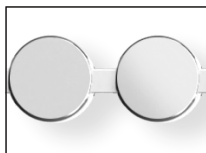

Rhodium (H) back

# Multi-Row Cupchains

## ARTICLE EXPLANATION - BASE ITEM NUMBER

**27 004** Multi-Row Cupchains

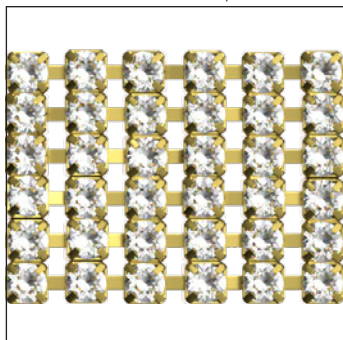

2	7	0	04	R
Product category	Stone code (type of stone used)	Setting code	Number of prongs in the setting (always 2-digit code)	Number of rows
2 Cupchains	7 Round	0 Basic	04	This article is available from 2 to 10 rows.

Multi-Row Cupchains

## ORDERING EXAMPLE &amp; PRODUCT VARIETY EXPLANATION

## Single Color Variant

<b>1</b>	<b>27 004</b>	<b>P24</b>	<b>03</b>	<b>C</b>
Material type	Base item number	Stone size	Number of rows	Back configuration
1 Brass		3-digit code from respective product matrix	02-10	C Closed
<b>C1</b>	<b>Z</b>	<b>1028</b>	<b>F</b>	<b>001</b>
Stone pattern	Plating	Base item art. no.	Foiling	Color of crystals
A1 Crystal with effect C1 Color K1 Crystal	Z No Plating	1028 1088	F Foiled	

## Motif Variant

<b>1</b>	<b>63 808</b>	<b>P24</b>	<b>03</b>	<b>C</b>
Material type	Base item number	Stone size	Number of rows	Back configuration
1 Brass	Generated by SC Office (Unique)	3-digit code from respective product matrix	02-10	C Closed
<b>M9</b>	<b>Z</b>	<b>1028</b>	<b>F</b>	<b>001 280 215</b>
Number of colors used within motif (2 to 9 colors)	Plating	Base item art. no.	Foiling	List of colors of crystals
M2-M9	Z No Plating	1028 1088	F Foiled	

**27 004** Multi-Row Cupchains

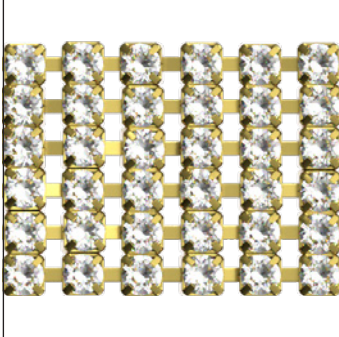

<b>R</b>	02-10
<b>E</b>	1028/1088
<b>M</b>	5 M <b>300%<sup>1</sup></b>

**Available Stone Sizes:**

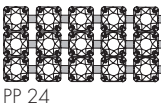
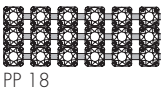
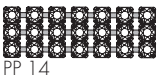
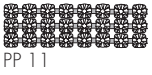

Multi-Row Cupchains

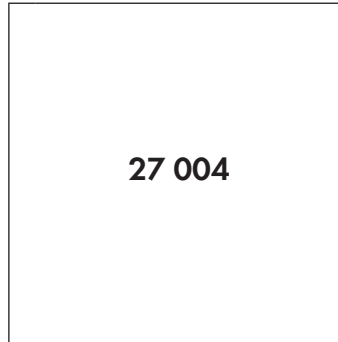

Size	PP 11	PP 14	PP 18	PP 24
------	-------	-------	-------	-------

**Crystal**

Crystal F (001)

**Colors**

**Plain Colors**

Amethyst F (204)

Aquamarine F (202)

Black Diamond F (215)

Chrysolite F (238)

Citrus Green F (337)

Denim Blue F (266)

Emerald F (205)

Golden Topaz F (1003)

Greige F (284)

Iris F (219)

Jet (280)

Light Amber F (1002)

Light Amethyst F (212)

Light Colorado Topaz F (246)

Light Rose F (223)

Light Sapphire F (211)

Light Siam F (227)

Light Topaz F (226)

Light Turquoise F (263)

Montana F (207)

Peridot F (214)

Rose F (209)

Rose Peach F (262)

Sapphire F (206)









Scarlet F (276)

Siam F (208)

Silk F (391)

Smoked Amber F (1001)

<sup>1</sup> The picture shows size PP 11

27 004		Size	PP 11	PP 14	PP 18	PP 24
	Tanzanite F (539)		■	■	■	■
	Vintage Rose F (319)		■	■	■	■
	Violet F (371)		■	■	■	■
<b>Opal Colors</b>						
	White Opal F (234)		■	■	■	■
<b>Crystal Effects</b>						
<b>Transparent Effects</b>						
	Crystal Aurore Boreale F (001 AB)		■	■	■	■
	Crystal Golden Shadow F (001 GSHA)		■	■	■	■
	Crystal Moonlight F (001 MOL)		■	■	■	■
	Crystal Silver Night F (001 SINI)		■	■	■	■
	Crystal Silver Shade F (001 SSHA)		■	■	■	■

**AVAILABLE PLATING COLORS**

Standard cupchains are available in brass (unplated). The customer can use these cupchains for soldering, before plating them on their own.

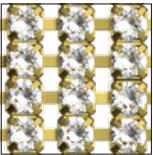

Brass (Z) front

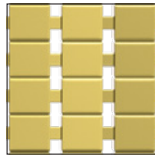

Brass (Z) back

INSPIRATIONAL MOTIFS

63 800

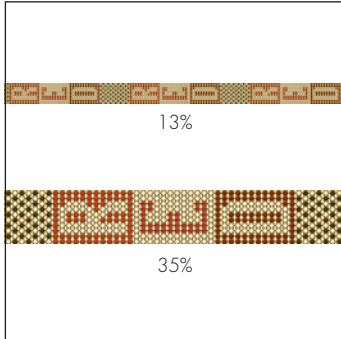

**C** BRASS-001/227/208/280/276  
**E** PP11/PP11/PP11/PP11/PP11  
**S** ~122x20 MM (48x10 ELEMENTS)  
**M** 5.02 METRES

63 801

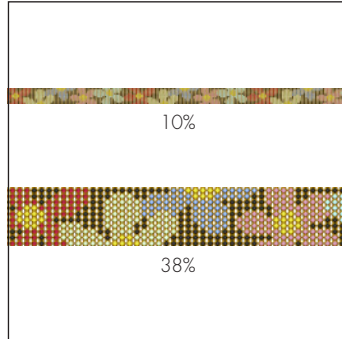

**C** BRASS-280/202/276/209/214/206/226  
**E** PP11/PP11/PP11/PP11/PP11/PP11/PP11  
**S** ~163x20 MM (64x10 ELEMENTS)  
**M** 5.06 METRES

63 802

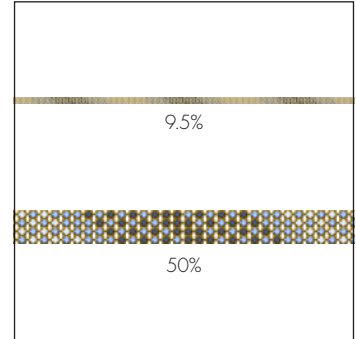

**C** BRASS-211/206/001/207  
**E** PP14/PP14/PP14/PP14  
**S** ~158x9 MM (54x4 ELEMENTS)  
**M** 5.06 METRES

Multi-Row Cupchains

63 803

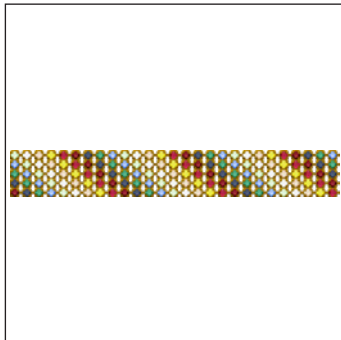

**C** BRASS-246/226/276/208/207/205/206/214/001  
**E** PP14/PP14/PP14/PP14/PP14/PP14/PP14/PP14/PP14  
**S** ~26x11 MM (9x5 ELEMENTS)  
**M** 5.01 METRES **55%**

63 805

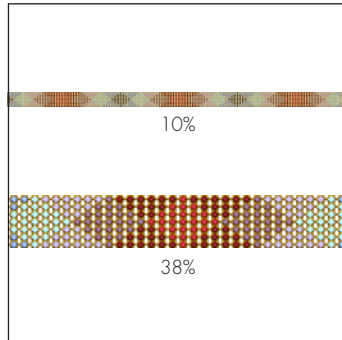

**C** BRASS-202/204/206/539/208/207/227  
**E** PP18/PP18/PP18/PP18/PP18/PP18/PP18/PP18  
**S** ~154x18 MM (42x7 ELEMENTS)  
**M** 5.09 METRES

63 804

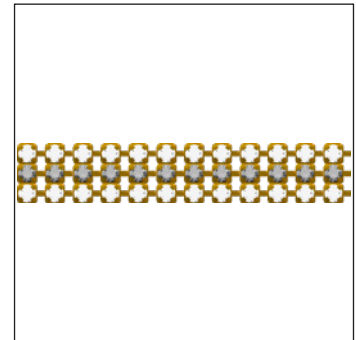

**C** BRASS-001/001SINI  
**E** PP18/PP18  
**S** ~15x8 MM (4x3 ELEMENTS)  
**M** 5.01 METRES **100%**

63 806

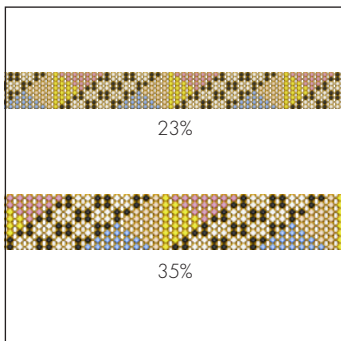

**C** BRASS-280/001/246/226/209/206  
**E** PP18/PP18/PP18/PP18/PP18/PP18  
**S** ~66x21 MM (18x8 ELEMENTS)  
**M** 5.02 METRES

63 807

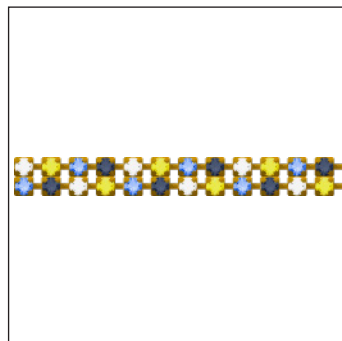

**C** BRASS-226/207/206/001  
**E** PP24/PP24/PP24/PP24  
**S** ~18x6 MM (4x2 ELEMENTS)  
**M** 5.02 METRES **80%**

63 808

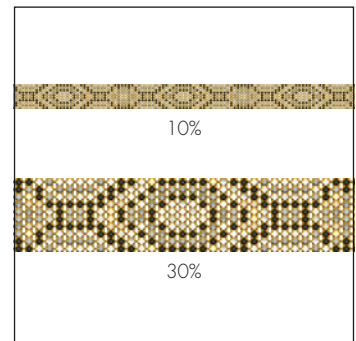

**C** BRASS-280/001/001SSHA/234/001SINI/215/246/001GSHA/391  
**E** PP24/PP24/PP24/PP24/PP24/PP24/PP24/PP24/PP24  
**S** ~158x32 MM (35x10 ELEMENTS)  
**M** 5.5 METRES



## SPECIAL MOTIF SERVICE

A special motif is a design created by the customer that differs to the Multirow Cupchains Standard Collection and Inspirational Motifs. This service opens up an abundance of customization possibilities and enables you to profit from Swarovski's long-standing experience and design expertise. A range of customization options for existing motifs is available (see "Customization Possibilities"

below). You can also submit design sketches that meet your special needs, such as a brand image or an image for a particular sales campaign. This will then be made up according to your specifications using Computer Aided Design, which means that adjustments can be made easily according to your needs.

### Customization Possibilities

- Change of size or color of an existing motif
- Creation of a new motif (ex. Logos, brand names, patterns...)
- Up to nine colors are possible per Multirow Cupchains Motif
- Each motif can have a maximum length of 20 cm. The motif will then repeat within the Multirow Cupchains roll

### Ordering Process

Send your request with the drawing you wish to order to your nearest Swarovski sales office.

Make sure you include all measurements for the desired motif, as well as the size of the desired cupchains and the numbers of rows you wish to have (2 to 10 maximum).

You will then receive a quotation including your article number, minimum order quantity, price, and the line drawing of your special motif in PDF format.

Please contact your Swarovski sales office again if any changes are required. Your special motif will be produced and delivered following your confirmation.

### Please Note

Please always submit the drawing of your desired motif to represent it in the actual size you require. A small sketch, when enlarged to the desired size, will have blurred lines that will make it difficult to correctly reproduce. Pictures or drawings representing 100% size of the design or very good quality scans in JPG, BMP, or DXF format will ensure that we have clear data to work with. These can also be sent via email. If sending a sewing pattern, please include the whole pattern and not just sections. When the sketch is submitted as a copy by email, please include a scale

legend (e.g. copy/scan with a ruler next to the drawing). This will ensure that the desired size of the motif can be identified.

Special productions are generally offered to all our customers if these are deemed to be feasible and comply with our General Terms and Conditions. Please note ordering of a design does not grant exclusive production of this design to the customer.



# Bandings

Bandings consist of crystals set into cups that are held together by thread. They are available in different thread colors, and can be applied by sewing or gluing. Available in different casings, and colors.

# Crystal Fishnet Banding

## ARTICLE EXPLANATION

**50 310** Crystal Fishnet Banding

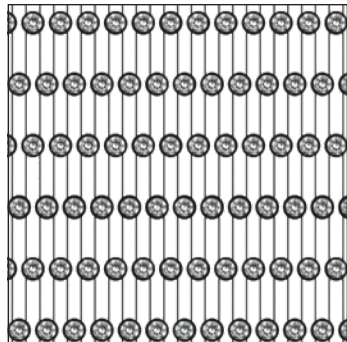

<b>R</b>	070	
<b>E</b>	1088 SS 8	
<b>M</b>	10 M	<b>100%</b>

Crystal Fishnet Banding

50 310	R	E	M	100%
Article number	Number of rows	Elements	Minimum order quantity in meters (M)	% of actual size
	This article is available in 70 rows.	Crystals and stone size used		

## ORDERING EXAMPLE & PRODUCT VARIETY EXPLANATION

50 310	070	012	Black Casing	001	AB
Article number	3-digit code for number of rows	Color of thread	Color of casing	Color of crystals	Effect
		012 Black 015 Burgundy 022 White 191 Navy 192 Silk	012 Black 015 Burgundy 022 White 191 Navy 192 Silk	Please see the relevant product matrix for all available reference codes.	

**AVAILABLE THREAD & CASING COLORS**

Crystal Fishnet Bandings are available in 5 standard color combinations. Customization possibilities are available upon special request via the customer service office.

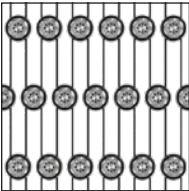

012 012  
Black thread and casing

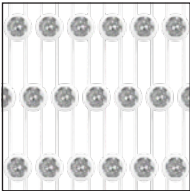

022 022  
White thread and casing

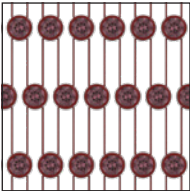

015 015  
Burgundy thread and casing

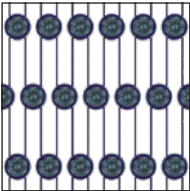

191 191  
Navy thread and casing

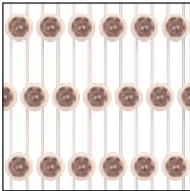

192 192  
Silk thread and casing

**50 310** Crystal Fishnet Banding

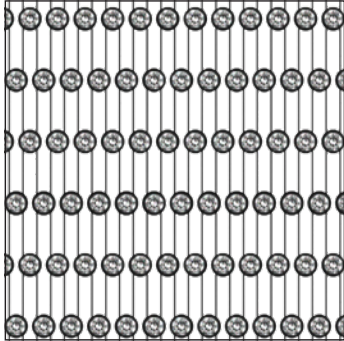

**R** 070  
**E** 1088 SS 8  
**M** 10 M **100%**

**50 311** Crystal Fishnet Banding

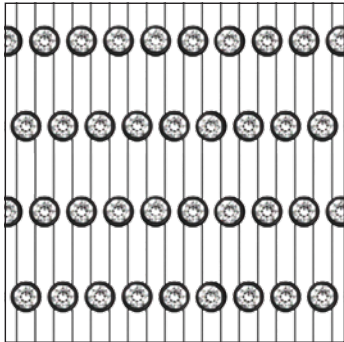

**R** 053  
**E** 1088 SS 12  
**M** 10 M **100%**

**50 312** Crystal Fishnet Banding

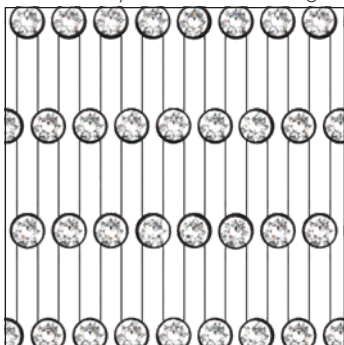

**R** 045  
**E** 1088 SS 16  
**M** 10 M **100%**

50 310  
50 311  
50 312

<b>Crystal</b>	Crystal F (001)	■	■	■
<b>Colors</b>				
<b>Plain Colors</b>				
● Graphite F (253) <sup>1</sup>	■	■	■	
● Montana F (207) <sup>2</sup>	■	■	■	
● Scarlet F (276) <sup>3</sup>	■	■	■	
● Silk F (391) <sup>4</sup>	■	■	■	
<b>Crystal Effects</b>				
<b>Transparent Effects</b>				
● Crystal Aurore Boreale F (001 AB) <sup>5</sup>	■	■	■	

Size

SS 8
  SS 12
  SS 16

<sup>1</sup> Graphite is only available with 012 012 black thread and casing.  
<sup>2</sup> Montana is only available with 191 191 navy thread and casing.  
<sup>3</sup> Scarlet is only available with 015 015 burgundy thread and casing.  
<sup>4</sup> Silk is only available with 192 192 silk thread and casing.  
<sup>5</sup> Crystal Aurore Boreale is only available with 022 022 white thread and casing.



# Crystal Rivets & Rose Pins

Crystal Rivets and Rose Pins are forward integrated products that can be mechanically applied onto different fabrics, leather, or other materials. Offering flexibility and versatility in designs, they are bestsellers in textile, footwear and accessory segments, due to the wide range of application possibilities.







# Crystal Rivets

## ARTICLE EXPLANATION

### 53 001 Rivets



<b>E</b>	1088 SS 29	
<b>M</b>	500 PCS	<b>150%</b>

53 001	E	M	150%
Article number	Elements Crystals and stone size used	Minimum order quantity in pieces (PCS)	% of actual size

Crystal Rivets

## ORDERING EXAMPLE & PRODUCT VARIETY EXPLANATION

53 001	082	001
Article number	Color of casing 081 Gold 082 Silver 086 Gun Metal 088 Stainless Steel	Color of crystals Please see the respective product matrix for all available reference code.

Please note that the Back Parts for Rivets must be ordered separately. Please see the respective product matrix for all available Back Parts on page 406.

**RIVETS**

**53 001 Rivets**



**E** 1088 SS 29  
**M** 500 PCS **150%**

**53 005 Rivets**



**E** 1088 SS 34  
**M** 500 PCS **150%**

**53 006 Rivets**

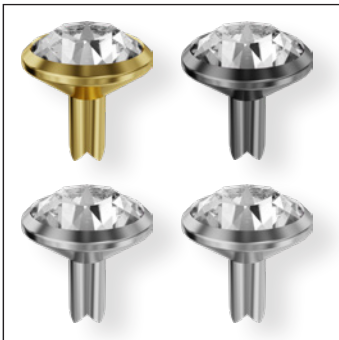

**E** 1088 SS 39  
**M** 300 PCS **150%**

53 001 53 005 53 006		Size	SS 29	SS 34	SS 39
<b>Crystal</b>		Crystal F (001)	■	■	■
<b>Colors</b>					
<b>Plain Colors</b>					
	Amethyst F (204)	■	■	■	
	Aquamarine F (202)	■	■	■	
	Black Diamond F (215)	■	■	■	
	Chrysolite F (238)	■	■	■	
	Citrus Green F (337)	■	■	■	
	Denim Blue F (266)	■	■	■	
	Emerald F (205)	■	■	■	
	Golden Topaz F (1003)	■	■	■	
	Greige F (284)	■	■	■	
	Iris F (219)	■	■	■	
	Jet (280)	■	■	■	
	Light Amber F (1002)	■	■	■	
	Light Amethyst F (212)	■	■	■	
	Light Colorado Topaz F (246)	■	■	■	
	Light Rose F (223)	■	■	■	
	Light Sapphire F (211)	■	■	■	
	Light Siam F (227)	■	■	■	
	Light Topaz F (226)	■	■	■	
	Light Turquoise F (263)	■	■	■	
	Montana F (207)	■	■	■	
	Peridot F (214)	■	■	■	
	Rose F (209)	■	■	■	
	Rose Peach F (262)	■	■	■	
	Sapphire F (206)	■	■	■	
	Scarlet F (276)	■	■	■	
	Siam F (208)	■	■	■	
	Silk F (391)	■	■	■	

Crystal Rivets

<b>53 001</b> <b>53 005</b> <b>53 006</b>			
	<b>Size</b>		
	SS 29	SS 34	SS 39
Smoked Amber F (1001)			
Tanzanite F (539)			
Vintage Rose F (319)			
Violet F (371)			
<b>Opal Colors</b>			
White Opal F (234)			
<b>Crystal Effects</b>			
<b>Transparent Effects</b>			
Crystal Aurore Boreale F (001 AB)			
Crystal Golden Shadow F (001 GSHA)			
Crystal Ignite (001 IGNIT)			
Crystal Moonlight F (001 MOL)			
Crystal Silver Night F (001 SINI)			
Crystal Silver Shade F (001 SSHA)			
<b>Crystal Lacquer<sup>PRO</sup> Effects</b>			
<b>Crystal Lacquer<sup>PRO</sup> Ignite Effects</b>			
Crystal Flamingo Ignite (001 L162I)			
Crystal Linen Ignite (001 L164I)			
Crystal Maroon Ignite (001 L160I)			
Crystal Orange Ignite (001 L159I)			
Crystal Purple Ignite (001 L161I)			
Crystal Sky Ignite (001 L163I)			

<b>53 001</b> <b>53 005</b> <b>53 006</b>			
	<b>Size</b>		
	SS 29	SS 34	SS 39
<b>Crystal Lacquer<sup>PRO</sup> DeLite Effects</b>			
Crystal Dusty Pink DeLite (001 L149D)			
Crystal Ivory Cream DeLite (001 L106D)			
Crystal Laguna DeLite (001 L142D)			
Crystal Lavender DeLite (001 L144D)			
Crystal Lotus Pink DeLite (001 L145D)			
Crystal Ocean DeLite (001 L143D)			
Crystal Orange Glow DeLite (001 L146D)			
Crystal Royal Blue DeLite (001 L110D)			
Crystal Royal Red DeLite (001 L107D)			
Crystal Serene Gray DeLite (001 L150D)			
Crystal Silky Sage DeLite (001 L147D)			
<b>Color Effects</b>			
<b>Transparent Effects</b>			
Amethyst Ignite (204 IGNIT)			
Aquamarine Ignite (204 IGNIT)			
Emerald Ignite (205 IGNIT)			
Light Colorado Topaz Ignite (246 IGNIT)			
Light Rose Ignite (223 IGNIT)			
Scarlet Ignite (276 IGNIT)			
<b>Color Effects</b>			
<b>Metallic Effects</b>			
Jet Hematite F (280 HEM)			

**Available Casing Colors**

Rivets are available in gold, silver and gunmetal plated casing, as well as Stainless Steel.



081 Gold



082 Silver





086 Gun Metal



088 Stainless Steel

Tools for Fly Press

Required Application Tools	Upper Die	Vacuum Adapter <sup>1</sup>	Spare Part for Upper Die (insert) <sup>2</sup>	Lower Die for application with Back Part:	Lower Die for application with Back Part:	Lower Die for application without Back Part for Rivet Casing	Lower Die for application without Back Part for Rivet Casing Color
			Art. 9040/023		 53 007	 53 009	088 Stainless Steel
							
				Art. 9070/010	Art. 9070/012	Art. 9070/011	Art. 9040/015

53 001



Art. 9070/005 M8	Art. 9040/023	Art. 9070/008
Art. 9070/009 M6	-	

53 005



Art. 9040/064 M8	Art. 9040/023	Art. 9040/062
Art. 9040/063 M6	-	

53 006



Art. 9040/067 M8	Art. 9040/023	Art. 9040/065
Art. 9040/066 M6	-	

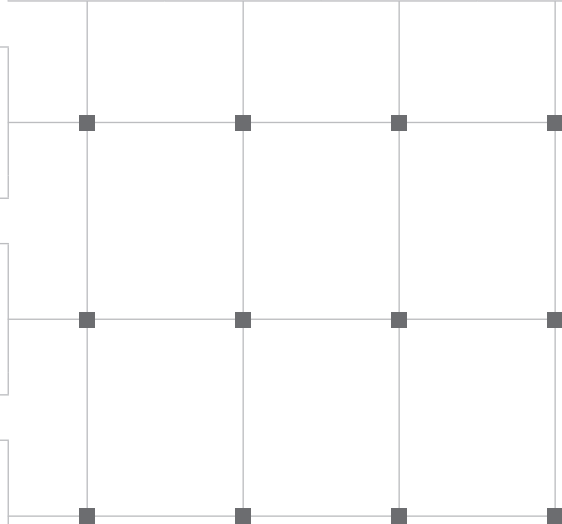

<sup>1</sup> When using Swarovski's fly press, tools with M8 thread and the corresponding vacuum adapter are necessary.

<sup>2</sup> The Spare Part (plastic insert) is incorporated into the Upper Die as standard. It should be changed when it becomes worn.

**Back Parts for Rivets**

**53 007**

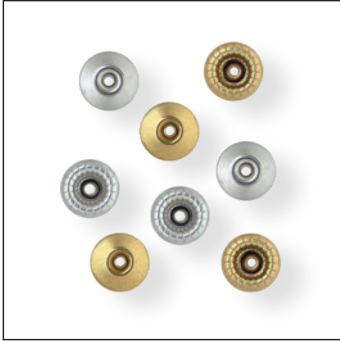

**M** 1,000 PCS **100%**

**53 009**



**M** 1,000 PCS **100%**

Crystal Rivets & Rose Pins

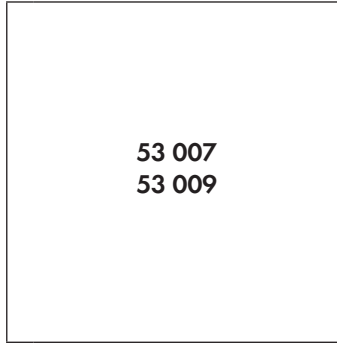

**Rivets (Color of Casing)**

53 001 (081/082/086)	■	■
53 001 (088)	■	■
53 005 (081/082/086)	■	■
53 005 (088)	■	■
53 006 (081/082/086)	■	■
53 006 (088)	■	■

**Ordering Example & Product Variety Explanation**

<b>53 007</b>	<b>081</b>
Article number	Color of casing
	081 Gold
	088 Stainless Steel

# Rose Pins

## ARTICLE EXPLANATION

### 53 301 Rose Pins



<b>E</b>	2038 SS 10
<b>M</b>	1,440 PCS <b>250%</b>

53 301	E	M	250%
Article number	Elements Crystals and stone size used	Minimum order quantity in pieces (PCS)	% of actual size

### Ordering Example & Product Variety Explanation

53 301	088	001
Article number	Color of casing 088 Stainless Steel	Color of crystals Please see the respective product matrix for all available reference code.

**53 301** Rose Pins

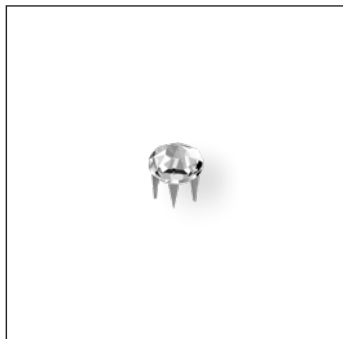

**E** 2038 SS 10  
**M** 1,440 PCS **250%**

**53 303** Rose Pins



**E** 2078 SS 20  
**M** 720 PCS **250%**

**53 302** Rose Pins



**E** 2078 SS 16  
**M** 1,440 PCS **250%**

**53 304** Rose Pins



**E** 2078 SS 34  
**M** 288 PCS **250%**

Rose Pins



<b>53 301</b> <b>53 302</b> <b>53 303</b> <b>53 304</b>	<b>Size</b>	SS 10	SS 16	SS 20	SS 34
--	-------------	-------	-------	-------	-------

<b>Crystal</b>					
Crystal Hifix Transparent (001 HFT)					
Crystal A HF (001)					
<b>Colors</b>					
<b>Plain Colors</b>					
Amethyst A HF (204)					
Aquamarine A HF (202)					
Black Diamond A HF (215)					
Blue Zircon A HF (229)					
Blush Rose A HF (257)					
Burgundy A HF (515)					
Capri Blue A HF (243)					
Chrysolite A HF (238)					
Citrus Green A HF (337)					
Cobalt A HF (369)					
Dark Indigo A HF (288)					
Burgundy A HF (515)					
Denim Blue A HF (266)					
Emerald A HF (205)					
Erinte A HF (360)					
Fern Green A HF (291)					
Fuchsia A HF (502)					
Golden Topaz A HF (1003)					
Graphite A HF (253)					
Greige A HF (284)					
Indian Pink A HF (289)					
Indian Siam A HF (327)					
Indicolite A HF (379)					
Iris A HF (219)					
Jet HFT (280)					
Jet A HF (280)					

<b>53 301</b> <b>53 302</b> <b>53 303</b> <b>53 304</b>	<b>Size</b>	SS 10	SS 16	SS 20	SS 34
--	-------------	-------	-------	-------	-------

Jonquil A HF (213)					
Light Amber A HF (1002)					
Light Amethyst A HF (212)					
Light Colorado Topaz A HF (246)					
Light Peach A HF (362)					
Light Rose A HF (223)					
Light Sapphire A HF (211)					
Light Siam A HF (227)					
Light Silk A HF (261)					
Light Topaz A HF (226)					
Light Turquoise A HF (263)					
Majestic Blue A HF (296)					
Montana A HF (207)					
Padparadscha A HF (542)					
Peridot A HF (214)					
Provence Lavender A HF (283)					
Purple Velvet A HF (277)					
Rose A HF (209)					
Rose Peach A HF (262)					
Ruby A HF (501)					
Sapphire A HF (206)					
Scarlet A HF (276)					
Siam A HF (208)					
Silk A HF (391)					
Smoked Amber A HF (1001)					
Tanzanite A HF (539)					
Topaz A HF (203)					
Vintage Rose A HF (319)					
<b>Opal Colors</b>					
White Opal A HF (234)					

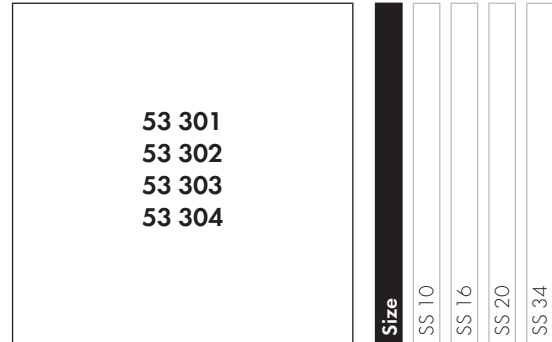
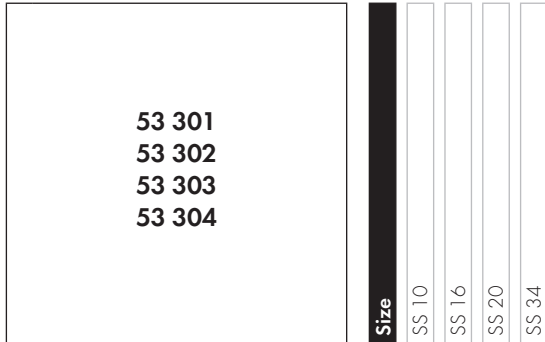

	Size	SS 10	SS 16	SS 20	SS 34
<b>Crystal Effects</b>					
<b>Transparent Effects</b>					
Crystal Aurore Boreale A HF (001 AB)		■	■	■	■
Crystal Blue Shade A HF (001 BLSH)		■	■	■	■
Crystal Golden Shadow A HF (001 GSHA)		■	■	■	■
Crystal Moonlight A HF (001 MOL)		■	■	■	■
Crystal Paradise Shine A HF (001 PARSH)		■	■	■	■
Crystal Shimmer A HF (001 SHIM)		■	■	■	■
Crystal Silver Night A HF (001 SINI)		■	■	■	■
Crystal Silver Shade A HF (001 SSHA)		■	■	■	■
Crystal Transmission HFT (001 TRA)		■	■	■	■
Crystal Volcano A HF (001 VOL)		■	■	■	■
<b>Metallic Effects</b>					
Crystal Light Chrome A HF (001 LTCH)		■	■	■	■
Crystal Metallic Sunshine A HF (001 METSH)		■	■	■	■
Crystal Rose Gold A HF (001 ROGL)		■	■	■	■
<b>Crystal Lacquer<sup>PRO</sup> Effects</b>					
<b>Crystal Lacquer<sup>PRO</sup> Ignite Effects</b>					
Crystal Flamingo Ignite HFT (001 L162I)		■	■	■	■
Crystal Linen Ignite HFT (001 L164I)		■	■	■	■
Crystal Maroon Ignite HFT (001 L160I)		■	■	■	■
Crystal Orange Ignite HFT (001 L159I)		■	■	■	■
Crystal Purple Ignite HFT (001 L161I)		■	■	■	■
Crystal Sky Ignite HFT (001 L163I)		■	■	■	■
<b>Crystal Electric Lacquer<sup>PRO</sup> Effects*</b>					
Crystal Electric Blue HFT (001 L134S)		■	■	■	■
Crystal Electric Green HFT (001 L135S)		■	■	■	■
Crystal Electric Orange HFT (001 L136S)		■	■	■	■
Crystal Electric Pink HFT (001 L137S)		■	■	■	■
Crystal Electric Violet HFT (001 L148S)		■	■	■	■
Crystal Electric White HFT (001 L139S)		■	■	■	■
Crystal Electric Yellow HFT (001 L138S)		■	■	■	■

	Size	SS 10	SS 16	SS 20	SS 34
<b>Color Effects</b>					
<b>Transparent Effects</b>					
Black Diamond Shimmer A HF (215 SHIM)		■	■	■	■
Blue Zircon Shimmer A HF (229 SHIM)		■	■	■	■
Capri Blue Nighfall A HF (243 NIFA)		■	■	■	■
Emerald Nighfall A HF (205 NIFA)		■	■	■	■
Fuchsia Shimmer A HF (502 SHIM)		■	■	■	■
Graphite Nighfall A HF (253 NIFA)		■	■	■	■
Jet AB A HF (280 AB)		■	■	■	■
Jonquil AB A HF (213 AB)		■	■	■	■
Light Rose AB A HF (223 AB)		■	■	■	■
Light Rose Shimmer A HF (223 SHIM)		■	■	■	■
Light Sapphire Shimmer A HF (211 SHIM)		■	■	■	■
Light Siam AB A HF (227 AB)		■	■	■	■
Light Siam Shimmer A HF (227 SHIM)		■	■	■	■
Peridot Shimmer A HF (214 SHIM)		■	■	■	■
Sapphire AB A HF (206 AB)		■	■	■	■
Siam Nighfall A HF (208 NIFA)		■	■	■	■
Silk Shimmer A HF (391 SHIM)		■	■	■	■
Tanzanite Shimmer A HF (539 SHIM)		■	■	■	■
Topaz Shimmer A HF (203 SHIM)		■	■	■	■
<b>Metallic Effects</b>					
Jet Hematite A HF (280 HEM)		■	■	■	■

\* The Electric Lacquer<sup>PRO</sup> effects are UV light resistant. Nonetheless, due to the presence of neon pigments in the lacquers, Swarovski recommends using the crystals only under artificial lights, as excessive sun exposure can cause the pigments to fade.

## Tools for Fly Press



## 53 301



Art. 9040/090 M6	Art. 9040/094	Art. 9070/013	Art. 9070/017
---------------------	---------------	---------------	---------------

## 53 302



Art. 9040/091 M6	Art. 9040/095	Art. 9070/014	-
---------------------	---------------	---------------	---

## 53 303



Art. 9040/092 M6	Art. 9040/096	Art. 9070/014	-
---------------------	---------------	---------------	---

## 53 304



Art. 9040/093 M6	Art. 9040/097	Art. 9070/016	-
---------------------	---------------	---------------	---

Rose Pins can be easily applied using a fly press, a semi- or fully-automated attaching machine. Please note the material thickness when selecting Rose Pins.

	ART.	SIZE	MATERIAL THICKNESS*
ROSE PINS	<b>53 301</b>	SS 10	1 – 2 mm
	<b>53 302</b>	SS 16	0.7 – 2 mm
	<b>53 303</b>	SS 20	0.7 – 2 mm
	<b>53 304</b>	SS 34	0.7 – 2 mm

<sup>1</sup> The Spare Part is integrated into the Upper Die as standard. It should be changed when it becomes worn.

<sup>2</sup> The centering aid (art. 9070/017) for Rose Pin 53 301 allows the product to be easily positioned in the upper die.

\* This can vary according to the softness and production of the carrier material.



# Application Tools

Swarovski offers a range of optimized application possibilities from gluing, and Hotfix through to sewing, and mechanical application to ensure seamless production of designs. The product assortment includes a wide range of glues, mechanical tools, and other application tools, meaning that crystals can be applied simply, quickly, and securely.

# Crystal Glues CG 500 (A+B) & CG 610 (A+B)

CG 500 (A+B) and CG 610 (A+B) are two-component epoxy resin glues especially developed for gluing both foiled and unfoiled crystals. The highest quality can be ensured by following the entire application process.

Please consult our Application Manual for detailed information.

## AVAILABLE PACKAGING VERSIONS

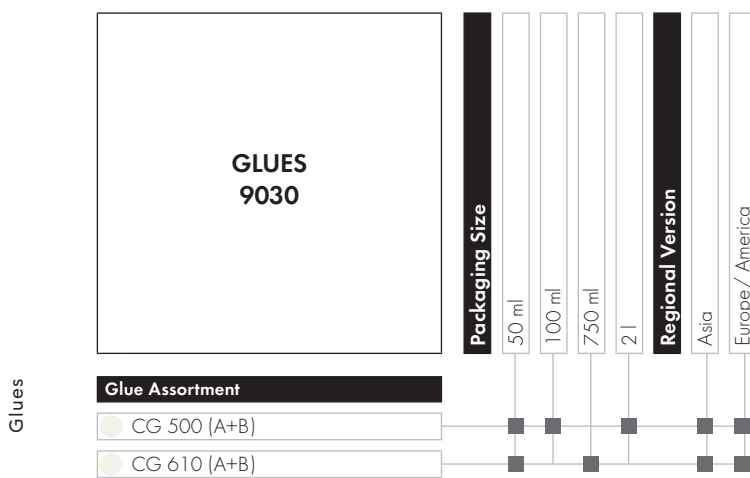

## ORDERING EXAMPLE & PRODUCT VARIETY EXPLANATION

9030	CG 500 (A+B)	100 ml	Europe/America
Article number	Crystal Glue type	Packaging size	Regional version
9030	CG 500 (A+B) CG 610 (A+B)	50 ml 100 ml 750 ml 2 l	Asia Europe/America

## Field of Application

	Color	Viscosity	Crystals	Glass	Ceramics	Stone	Aluminum	Brass	Silver	Steel	PC	PS	PVC/ABS	PMMA	Paper	Cork	Wood	Textiles <sup>1</sup>	Small Chatons (Xero)
CG 500 (A+B)	translucent	med	+	+	+	+	+	+	+	+	+	+	+	+	○	○	○	-	-
CG 610 (A+B)	translucent	low	+	+	+	+	+	+	+	+	+	+	○	○	○	○	○	-	+

**Please note:** packaging contains the total amount of glue, e.g.  
 CG 500 (A+B) 50 ml Cartridge = 25 ml component A and 25 ml component B (mixture ratio by volume 100:100 (A:B))  
 CG 610 (A+B) 50 ml Cartridge = 33.33 ml component A and 16.67 ml component B (mixture ratio by volume 100:50 (A:B)).

<sup>1</sup> For permanent (wash-resistant) applications, Hotfix application is recommended.

# Gluing Tools

Article number	Description	Details
9030/000	Test Pen	For the inspection of the surface tension.
9030/126	Mixing nozzle for CG 500 (A+B) and CG 610 (A+B)	The mixing nozzle is suitable for the 50 ml cartridge of both Crystal Glue types and comes in a packaging size of 10 pieces.
9040/022	Vacuum pump with silicone hose, can be adapted to a pick-up system	Dispensing tip for adapting the vacuum pump has to be ordered separately, suppliers are listed in the Application Manual, in the Gluing chapter.









# Mechanical Tools

## MACHINES & TOOLS FOR MECHANICAL APPLICATION

Article number	Description	Details
9040/019 & 9040/017	<p>9040/019 Fly press with mounting board</p> <p>9040/017 Fly press without mounting board</p>	<p>The fly press can be used to mechanically apply Swarovski crystals.</p> <p>To be used with mechanical tools. Inner thread of M6 spindle used to fix mechanical tools or vacuum adapters.</p>
9040/022	Vacuum pump for fly press	<p>Vacuum pump with silicone hose to hold Rose Pins, and Rivets in place in the fly press.</p>
9040/023	Vacuum adapter with M8 inner thread	<p>M6 outer thread to be fixed to fly press and M8 inner thread to hold the Upper Die. For Rivets.</p>

**TOOLS FOR RIVETS**

Required Application Tools	Upper Die	Vacuum Adapter <sup>1</sup>	Spare Part for Upper Die (Insert) <sup>2</sup>	Lower Die for application with Back Part:	Lower Die for application with Back Part:	Lower Die for application without Back Part for Rivet with casing color	Lower Die for application without Back Part for Rivet with casing color
							
	Art. 9040/023		Art. 9070/010	Art. 9070/012	Art. 9070/011	Art. 9040/015	

**53 001**



Art. 9070/005 M8	Art. 9040/023	Art. 9070/008
Art. 9070/009 M6 <sup>3</sup>	-	

**53 005**



Art. 9040/064 M8	Art. 9040/023	Art. 9040/062
Art. 9040/063 M6	-	

**53 006**



Art. 9040/067 M8	Art. 9040/023	Art. 9040/065
Art. 9040/066 M6	-	

Mechanical Tools

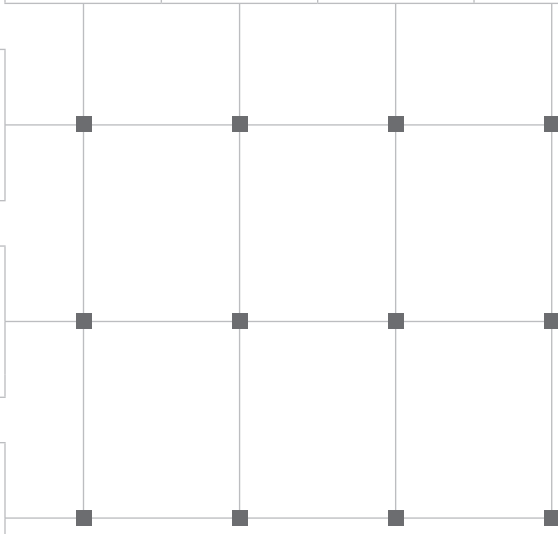





<sup>1</sup> When using the Swarovski fly press, tools with M8 thread and the corresponding vacuum adapter are necessary.

<sup>2</sup> The Spare Part (plastic insert) is incorporated into the Upper Die as standard. It should be changed when it becomes worn.



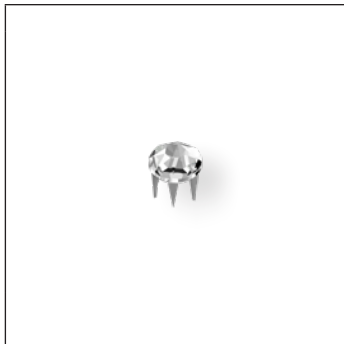

<sup>3</sup> Tools with no adapter (e.g. 9040/014 M6) can be screwed directly in a fly press. The fly press therefore must have the option of a vacuum directly through the shaft.

## TOOLS FOR ROSE PINS





## 53 301 Rose Pin (SS 10)

	Required Application Tools	Upper Die	Spare Part <sup>1</sup>	Lower Die	Centering Aid <sup>2</sup>
		 Art. 9040/090 M6	 Art. 9040/094	 Art. 9070/013	 Art. 9070/017





## 53 302 Rose Pin (SS 16)

	Required Application Tools	Upper Die	Spare Part <sup>1</sup>	Lower Die
		 Art. 9040/091 M6	 Art. 9040/095	 Art. 9070/014

## 53 303 Rose Pin (SS 20)

	Required Application Tools	Upper Die	Spare Part <sup>1</sup>	Lower Die
		 Art. 9040/092 M6	 Art. 9040/096	 Art. 9070/014

## 53 304 Rose Pin (SS 34)

	Required Application Tools	Upper Die	Spare Part <sup>1</sup>	Lower Die
		 Art. 9040/093 M6	 Art. 9040/097	 Art. 9070/016

<sup>1</sup> The Spare Part (plastic insert) is integrated into the Upper Die as standard. It should be changed when it becomes worn.

<sup>2</sup> The Centering Aid (art. 9070/017) for Rose Pin 53 301 allows the product to be easily positioned in the Upper Die.

# Hotfix Application Tools

## TOOLS FOR HOTFIX APPLICATION

Hotfix Application Tools & Sewing, embroidery, and hand application Tools

Article number	Description	Details
<b>9010/002</b> 	Silicone ironing pad (foam) 134x100 cm, 54x40 in	Compensating pad for applying Transfers of different sizes of crystals
<b>9010/003</b> 	Teflon® foil 100x50 cm, 40x20 in	Teflon® foil to protect heated surfaces from any glue residue
<b>9010/005</b> 	Silicone pad 50x50x0.2 cm, 20x20x0.08 in	For application of Crystal Diamond Transfers
<b>9010/006</b> 	Silicone board 50x25x0.1 cm, 20x10x0.05 in	For hand setting and designing Transfers
<b>9010/007</b> 	Temperature measuring strips	To check temperature in a heat press at various points on the heating surface. It ensures that heat is distributed evenly across the surface.

## Table of Sizes

OPEN TO SEE SIZES

# Table of Sizes

• PP 0 0.70–0.80 mm	• PP 21 (SS 10) 2.70–2.80 mm	• SS 26 5.61–5.78 mm	• SS 45 9.85–10.19 mm
• PP 1 (SS 000) 0.80–0.90 mm	• PP 22 (SS 10) 2.80–2.90 mm	• SS 27 5.78–5.96 mm	
• PP 2 (SS 00) 0.90–1.00 mm	• PP 23 (SS 11) 2.90–3.00 mm	• SS 28 5.96–6.14 mm	• SS 46 10.19–10.54 mm
• PP 3 (SS 0) 1.00–1.10 mm	• PP 24 (SS 12) 3.00–3.20 mm	• SS 29 6.14–6.32 mm	
• PP 4 (SS 1) 1.10–1.20 mm	• PP 25 (SS 13) 3.20–3.30 mm	• SS 30 6.32–6.50 mm	• SS 47 10.54–10.91 mm
• PP 5 (SS 2) 1.20–1.30 mm	• PP 26 (SS 13) 3.30–3.40 mm	• SS 31 6.50–6.68 mm	
• PP 6 (SS 2) 1.30–1.35 mm	• PP 27 (SS 14) 3.40–3.50 mm	• SS 32 6.68–6.87 mm	• SS 48 10.91–11.30 mm
• PP 7 (SS 3) 1.35–1.40 mm	• PP 28 (SS 14) 3.50–3.60 mm	• SS 33 6.87–7.07 mm	
• PP 8 (SS 3) 1.40–1.50 mm	• PP 29 (SS 15) 3.60–3.70 mm	• SS 34 7.07–7.27 mm	• SS 49 11.30–11.72 mm
• PP 9 (SS 4) 1.50–1.60 mm	• PP 30 (SS 15) 3.70–3.80 mm	• SS 35 7.27–7.48 mm	
• PP 10 (SS 4) 1.60–1.70 mm	• PP 31 (SS 16) 3.80–4.00 mm	• SS 36 7.48–7.70 mm	• SS 50 11.72–11.97 mm
• PP 11 (SS 5) 1.70–1.80 mm	• PP 32 (SS 17) 4.00–4.10 mm	• SS 37 7.70–7.93 mm	
• PP 12 (SS 5) 1.80–1.90 mm	• PP 33 (SS 17) 4.10–4.20 mm	• SS 38 7.93–8.16 mm	• SS 55 12.97–13.22 mm
• PP 13 (SS 6) 1.90–2.00 mm	• SS 18 4.20–4.40 mm	• SS 39 8.16–8.41 mm	
• PP 14 (SS 6) 2.00–2.10 mm	• SS 19 4.40–4.60 mm	• SS 40 8.41–8.67 mm	• SS 60 14.22–14.47 mm
• PP 15 (SS 7) 2.10–2.20 mm	• SS 20 4.60–4.80 mm	• SS 41 8.67–8.95 mm	
• PP 16 (SS 7) 2.20–2.30 mm	• SS 21 4.80–4.90 mm	• SS 42 8.95–9.23 mm	• SS 65 15.47–15.72 mm
• PP 17 (SS 8) 2.30–2.40 mm	• SS 22 4.90–5.10 mm	• SS 43 9.23–9.53 mm	
• PP 18 (SS 8) 2.40–2.50 mm	• SS 23 5.10–5.27 mm	• SS 44 9.53–9.85 mm	• SS 70 16.72–16.97 mm
• PP 19 (SS 9) 2.50–2.60 mm	• SS 24 5.27–5.44 mm		
• PP 20 (SS 9) 2.60–2.70 mm	• SS 25 5.44–5.61 mm		• SS 75 17.97–18.22 mm







VALID FROM SEPTEMBER 2023

Sys.No. 5693737

Content is subject to change without notice. Errors and misprints excepted.

Please note, the actual products may deviate from the pictures in color and effect.

D. Swarovski Distribution GmbH, Swarovskistrasse 30, 6112 Wattens, Austria

© 2023 D. Swarovski Distribution GmbH. All rights reserved. Partial or total publication, transmission, copy, or other duplication of texts, graphics, pictures etc. which are to be found in this publication is forbidden without special consent by D. Swarovski Distribution GmbH.

Swarovski® is a registered trademark of Swarovski AG.

Please visit our website for contact information: [swarovski.com/s-professionals](https://www.swarovski.com/s-professionals)

Printed by ATHESIA, Innsbruck, Austria